

**THE RADIO EXPERIMENTER'S MAGAZINE**

HUGO GERNSBACK

Editor

# SHORT WAVE AND TELEVISION

September

WORLD'S  
LARGEST  
SHORT WAVE  
CIRCULATION



**New ELECTRON GUN**

**Projects Large  
Television Images**

See Page 214

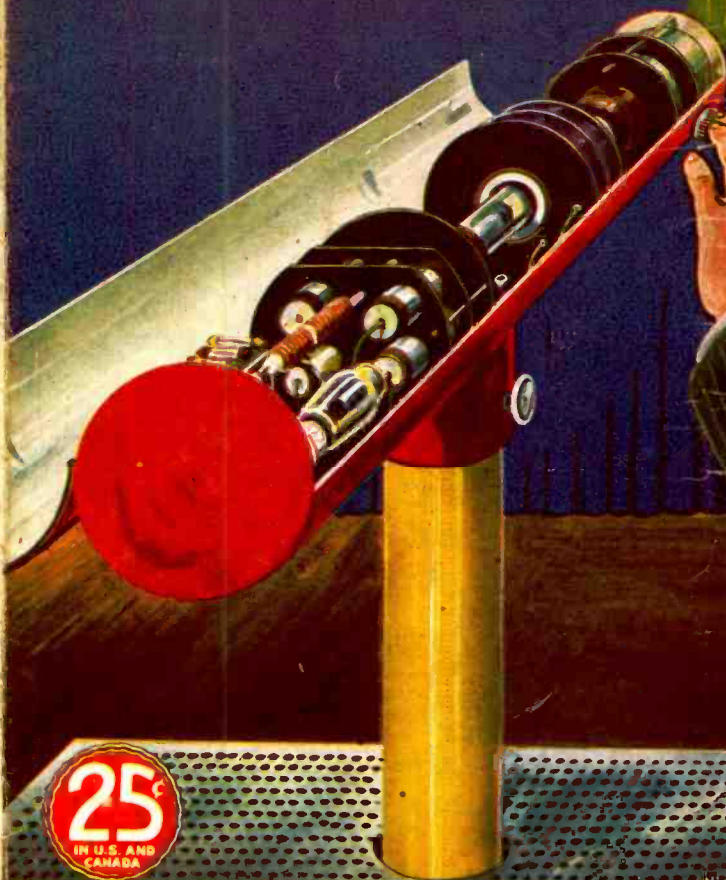

**25¢**  
IN U.S. AND  
CANADA



**RCA ALL  
THE WAY**

# RCA Radio News

RCA Manufacturing Company, Inc. • Camden, New Jersey  
A Service of the Radio Corporation of America

**EVERYTHING IN  
RADIO-MICROPHONE  
TO LOUDSPEAKER**

To the consumer, RCA means high quality performance at low cost...To the radio man, RCA means easier selling, higher profits

## TUNING 50 TIMES EASIER

### *New RCA Victor Overseas Dial Is Short Wave Sensation*

**Electric Tuning Also Scores. Push a Button—There's Your Station!**

**Remote Tuning Achieved by Fool-Proof Armchair Control Device**

Short wave fans are buzzing about the new 1938 RCA Victor Overseas Dial, a radical departure which makes short wave tuning easier than domestic.

The individual band scales representing the popular international entertainment bands are each 9½ inches long. This compares with the ¼-inch segments on the usual short wave dials. By actual measurement the crowded short wave stations are spread fifty times wider.



Each wave band lights up only when in use. Foreign stations appear by name on the dial scales.

The Overseas Dial is the leader of four improved dials in the 1938 RCA Victors. All are larger, easier to read.

Another major RCA Victor improvement is Electric Tuning—the first that's truly automatic. Push a button—there's your station. It's as simple as that. Gets any eight stations, foreign or domestic.

Electric Tuning may be extended to your easy chair with Armchair Control which may also be placed anywhere, in any room, that is convenient.

A fourth big new RCA Victor feature is the Sonic-Arc Magic Voice, which applies the principle of a band shell to bring finer tone, free from boomy reverberation.

RCA Victor Dealers are now demonstrating the 39 new 1938 models, ranging in price from \$20 up. All models incorporate a generous number of RCA Victor's 55 great extra-value features.

RCA Victor Model 811K featuring new Straight-Line Dial and Electric Tuning, 11 tubes, new Sonic-Arc Magic Voice, Magic Brain, Magic Eye, RCA Metal Tubes, covers standard broadcast band and 49, 31, 25, and 19, 16 and 13 meter bands of international entertainment. Armchair Tuning available at slight extra cost. \$150. (f.o.b.) Camden, N. J., subject to change without notice.

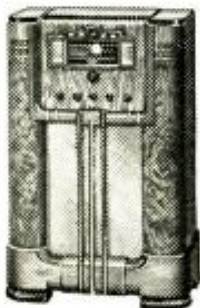

### **Fall Radiotron Check-Up Gets Under Way**

**Gives Old Sets New Life... RCA Offers Outstanding Selling Helps**



Window Display scheduled for delivery in September. See your distributor about yours.

To alert service men and dealers, September means the RCA Radiotron Check-Up Plan. Experience proves this plan gives radio dealers and service men a fine opportunity to make money.

The RCA Radiotron Check-Up puts new life in radios that are wobbling on their last legs. It's good for them. Makes them perform like they did when new. And it's a service most radio owners are glad to pay for—because the job is so satisfactory and the cost is so small.

To dealers and service men the Check-Up means more service jobs—at a minimum of \$1.50 a job. It means not only a chance to sell tubes, but by providing entry into the various homes in the community, an opportunity for the sale of many other electrical products.

The RCA Radiotron Check-Up is easy to sell: first, because it's an excellent service; second, because RCA backs it up with selling helps and advertising that does a job.

The Saturday Evening Post and Collier's will carry timely ads on Check-Up every other week. Real selling commercials will be plugged on a full hour radio program every Sunday. Besides these, there are scores of store helps available to you, plus tested direct mail pieces, such as letters and postcards, the Listening Ear, auto door hangers, auto radio check-up letters—every one of which packs a real selling punch. See your distributor.

Get behind the RCA Radiotron Fall Check-Up campaign—and your cash register will bang out a merry tune. Full details from your jobber.

Ask your RCA Parts Distributor for new RCA Parts Catalog and data about Magic Wave Antenna System.

### **New Antenna Cuts Noise**

**RCA Magic Wave Antenna System  
Operates up to 16 Outlets  
on One Antenna**



No improvement in radio reception is more universally desired than the elimination or the reduction of noise. RCA now offers a product that does the job! The new Magic Wave Antenna System provides noise reduction on both standard and international short wave bands from 530 to 23,000 kcs. This is due to use of a new magnetite core transformer and the transmission line.

#### **Operates 16 Outlets at One Time**

The Magic Wave Antenna will operate up to 16 outlets on one antenna. This is possible through the use of additional special distribution and set coupling transformers.

The length of the antenna proper may be varied between 20 and 120 feet, making for ease of installation—yet retaining excellent efficiency. The transmission line is also variable to any desired length, again with a minimum of losses. No doublets or critical lengths required. Adaptable to existing installations.

#### **Can Be Used for Vertical Installations**

By using several lengths of ordinary iron pipe and reduction couplings, a high efficiency vertical antenna may be used in conjunction with the RCA Magic Wave System. By using stock number 12429, Submarine Cable, the transmission line may be buried and all unsightly wiring eliminated. Such an installation can be conveniently located remote from interference.

The new RCA Magic Wave Antenna System consists of one antenna coupling transformer and one receiver coupling transformer. Each coupling unit has two transformers in which magnetite cores are used. One of the transformers responds with greater efficiency on the standard broadcast band. The other on the international short wave band.

The Magic Wave Antenna System, stock 9812, lists at \$6.95, assembled in one complete unit ready for installation.



# Read what happened



**YES!**

I'll take your training. That's what S. J. Ebert said. He is making good money and has found success in Radio.

to these  
two men

when I said:



**NO!**

I'm not interested. That's what this fellow said. Today he would be ashamed if I gave you his real name and salary.

## I will Train You at Home in Spare Time for a GOOD JOB IN RADIO

These two fellows had the same chance. Each sent me a coupon, like the one in this ad. They got my book on Radio's opportunities.

S. J. Ebert, 104-B Quadrangle, University of Iowa, Iowa City, Iowa, saw Radio offered him a real chance. He enrolled. The other fellow, whom we will call John Doe, wrote he wasn't interested. He was just one of those fellows who wants a better job, better pay, but never does anything about it. One of the many who spend their lives in a low-pay, no future job, because they haven't the ambition, the determination, the action it takes to succeed.

But read what S. J. Ebert wrote me and remember John Doe had the same chance: "Upon graduation I accepted a job as serviceman. Within three weeks I was made Service Manager. This job paid me \$40 to \$50 a week compared with \$18 I earned in a shoe factory before. Eight months later I went with station KWCR as operator. From there I went to KTNT. Now I am Radio Engineer with WSUI. I certainly recommend the N. R. I. to all interested in the greatest field of all, Radio."

**Get Ready for Jobs Like These.  
Many Radio Experts Make  
\$30, \$50, \$75 a Week**

Do you want to make more money? Broadcasting stations employ engineers, operators, station managers and pay up to \$5,000 a year. Spare time Radio set servicing pays as much

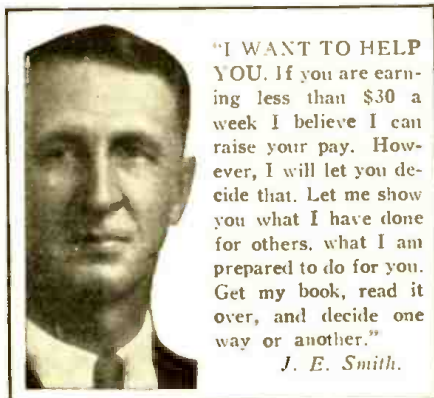

**"I WANT TO HELP YOU.** If you are earning less than \$30 a week I believe I can raise your pay. However, I will let you decide that. Let me show you what I have done for others, what I am prepared to do for you. Get my book, read it over, and decide one way or another."

J. E. Smith.

as \$200 to \$500 a year—full time Radio servicing jobs pay as much as \$30, \$50, \$75 a week. Many Radio Experts operate their own full time or part time Radio businesses. Radio manufacturers and jobbers employ testers, inspectors, foremen, engineers, servicemen, paying up to \$6,000 a year. Radio operators on ships get good pay and see the world besides. Automobile, police, aviation, commercial Radio and loud speaker systems offer good opportunities now and for the future. Television promises many good jobs soon. Men who have taken N. R. I. Training are holding good jobs in all these branches of Radio.

**Many Make \$5, \$10, \$15 a Week Extra  
in Spare Time While Learning**

Almost every neighborhood needs a good spare time serviceman. The day you enroll I start sending you Extra Money Job Sheets. They show you how to do Radio repair jobs, how to cash in quickly. Throughout your training I send you plans and ideas that made good spare time money for hundreds of fellows. I send you special Radio equipment, show you how to conduct experiments, build circuits illustrating important Radio principles. My training gives you valuable, practical experience while learning.

**Get My Free 64-Page Book Now**

Mail the coupon now for "Rich Rewards in Radio." It's free to anyone over 16 years old. It points out Radio's spare time and full time opportunities and those coming in Television; tells about my Training for Radio and Television; shows you letters from men I trained, telling what they are doing and earning; tells about my Money Back Agreement. MAIL THE COUPON in an envelope, or paste it on a penny postcard—NOW!

**J. E. SMITH, President  
National Radio Institute, Dept. 7JB3  
Washington, D. C.**



### FOR FREE BOOK OF FACTS ABOUT RADIO

**J. E. SMITH, President, National Radio Institute  
Dept. 7JB3, Washington, D. C.**

Without obligating me, send your service manual "Radio Receiver Troubles—Their Cause and Remedy" and free book about spare time and full time Radio opportunities and how I can train for them at home in my spare time. I am particularly interested in the branch of Radio checked below.

- Radio Service Business of My Own
- Spare Time Radio Service Work
- Retail Sales of Radio Sets and Equipment
- Broadcasting Station Operator
- Aviation Radio Operator
- Ship Radio Operator
- Auto Radio Installation and Service
- All-around Servicing Expert
- Loud Speaker Systems, Installation and Service
- Television Station Operator
- Designing and Construction Testing Equipment
- Service Expert with Radio Factory
- Commercial Radio Station Operator

(If you have not decided which branch you prefer—mail coupon now, for information to help you decide.)

NAME ..... AGE .....

ADDRESS ..... 14X-1

### Get My Lesson on Radio Servicing Tips FREE

I'll prove my Training gives practical, money-making information; is easy to understand—is just what you need to master Radio. My sample lesson text "Radio Receiver Troubles—Their Cause and Remedy" covers a long list of Radio receiver troubles in A.C., D.C., battery, universal, auto, T.R.F., super-heterodyne, all-wave, and other types of sets and a cross reference system gives you the probable cause and a quick way to locate and remedy these set troubles. A special section is devoted to receiver check-up alignment, balancing, neutralizing and testing. Get this lesson Free. No obligation. Just mail coupon.



Please mention SHORT WAVE & TELEVISION when writing advertisers



**IN THIS ISSUE: PROMINENT SHORT-WAVE AND TELEVISION AUTHORS**

**Peck • Spitz • McNish • Coronado • Shuart • Adams • Lynch**

**HUGO GERNSBACK**  
Editor



**H. WINFIELD SECOR**  
Managing Editor

**GEORGE W. SHUART, W2AMN**  
Associate Editor

*Combined With*  
**Official SHORT WAVE LISTENER**

**Contents for September, 1937**

Editorial—Mechanical Scanning for Television by William Hoyt Peck.....	213
New "Electron Gun" Projects Large Television Images.....	214
"Ghost Echo" Detector To Reduce Plane Crashes.....	214
Short Wave Pictorial.....	215
Spitz Flight Recorder, by Mae Noble Rineman.....	216
"Spot News" Transmitted by Television, by Robert Oakhill.....	217
Short-Wave Transmission and The Ionosphere, by A. G. McNish.....	218
How To Photograph Television Images.....	219
Weather Forecasting by Short Waves, by J. Merino y Coronado.....	220
World-Wide Short-Wave Review, by C. W. Palmer.....	221
A.B.C. Beginner's Short-Wave Set, by H. G. Cisin, M. E.....	222
A Twin-Pentode Receiver, by G. W. Shuart, W2AMN.....	223
An Effective S-W Pre-Selector, by Raymond P. Adams.....	224
806 "All-Band" Xmitter, by G. W. Shuart, W2AMN.....	226
5-Meter Beam Antenna, by Arthur H. Lynch, W2DKJ.....	228
Short-Wave Scouts—Forty-first Trophy Award.....	229
Piping R.F. with Concentric Lines, by P. H. Smith, Bell Telephone Labs.....	230
What's New In Short-Wave Apparatus.....	232
Let's "Listen In" with Joe Miller.....	234
World S-W Station List, by M. Harvey Gernsback.....	235
How To Identify Short Wave Stations.....	238
Short Waves and Long Raves.....	240
New S-W Apparatus of Interest to "Hams".....	242
\$5.00 For Best Kink.....	244
Short Wave League—"When To Listen In," by M. Harvey Gernsback.....	245
Short-Wave Question Box.....	246

**Features in the October Issue**

- A Dandy 4-tube receiver for "Ham" and "Fan" bands, by Ernest Kahlert, W2BHZ.
- A 5-meter 100-watt transmitter, with adjustable frequency to avoid QRM, by G. W. Shuart, W2AMN. Don't miss it!
- The 5-40-400 transmitter, Part 2, by Arthur H. Lynch, W2DKJ.
- Short wave antennas for "Fans" and "Hams", the best types and how to build them, by W2AMN.
- A Real Pocket-Size Receiver.
- A 7-tube Battery Superhet, by Mander Barnett.

**Certified Circuits**



● **SHORT WAVE & TELEVISION** goes to a large expense in verifying new circuits. When you see this seal it is your guarantee that such sets have been tested in our laboratories, as well as privately, in different parts of the country. Only "Constructional-Experimental" circuits are certified by us.

When you see our certified seal on any set described, you need not hesitate to spend money for parts, because you are assured in advance that the set and circuit are bona fide and that this magazine stands behind them.

**SHORT WAVE & TELEVISION** is the only magazine that certifies circuits and sets.

**OUR COVER**

● The cover illustration shows how large television images will be projected on a screen by the new "electron gun," devised by television experts of the RCA. The construction of the new television projection gun is described and illustrated with photos and diagrams on page 214.

COPYRIGHT, 1937, BY H. GERNSBACK

Published by **POPULAR BOOK CORPORATION**

404 N. Wesley Avenue, Mount Morris, Ill.

Editorial and Executive Offices - - - - 99-101 Hudson St., New York, N. Y.  
**HUGO GERNSBACK**, President - - - - **H. W. SECOR**, Vice-President  
**EMIL GROSSMAN** - - - - - Director of Advertising  
 European Agent: Gorrings' American News Agency, 9A Green St., Leicester Square, London W. C. 2  
 Australian Agents: **McGILL'S AGENCY**, 179 Elizabeth St., Melbourne

**SHORT WAVE & TELEVISION**—Monthly. Entered as second-class matter May 7, 1930, at the post office at Mount Morris, Illinois, under the act of March 3, 1879. Trademarks and copyrights by permission of H. Gernsback, 99-101 Hudson St., N. Y. C. Text and illustrations of this magazine are copyrighted and must not be reproduced without permission. **SHORT WAVE & TELEVISION** is published on the 1st of every month. Twelve numbers per year. Subscription price is \$2.50 a year in the United States and possessions and Canada. Foreign countries, \$3.00 a year. Single copies 25c. Address all contributions for publication to Editor **SHORT WAVE & TELEVISION**, 99-101 Hudson St., New York, N. Y. Publishers are not responsible for lost manuscripts. Contributions cannot be returned unless authors remit full postage. **SHORT WAVE & TELEVISION** is for sale at all principal newsstands in the United States and Canada. European agents: Brentano's, London and Paris. Printed in U. S. A. Make all subscription checks payable to Popular Book Corporation.



# EVERYTHING IN RADIO at Lowest Prices!

*The New*  
**1938**  
**ALLIED** *Catalog*  
*is Ready*

*61 Amazing New RADIOS*



New 1938 KNIGHT Radios with astounding new features—push-button tuning, AFC, Beam Power Tubes, Armchair and plastic cabinets, etc.! All-Wave and Dual-Wave—5 to 16 tubes—for AC, AC-DC, 6 Volt, 32 Volt, Battery and Auto operation. 61 great models at amazingly low prices!

*26 Newest Amateur Sets*



See the largest selection of Amateur Equipment in Radio! Page after page of the leading manufacturers—new RCA 111, new Hallicrafters models, new Utah X-mitters—a tremendous assortment of the latest transmitters, receivers and transceivers—in factory-built and kit form. 20,000 Amateurs buy at ALLIED because ALLIED's service is faster, ALLIED's prices are lower!



**FOR DEALERS**  
**SERVICE MEN • AMATEURS**  
**RADIO BUILDERS • SOUND MEN**

*More than 12,000 PARTS*



In ONE book—more than 12,000 exact duplicate and replacement parts—clearly indexed—specially arranged for split-second reference—saves hours of time over ordinary catalogs! No matter whether it's "hard-to-get" or everyday, it's in the ALLIED Catalog!

*32 New KITS*



A new, enlarged section for Radio Builders! Kits of every type, from a Beginners' 1 Tube Set to a 14 Tube All-Wave Superhet. We can supply matched kits for building any circuit in any radio publication. Write to us for Free Parts Lists. ALLIED is Radio Parts Headquarters for Radio Builders everywhere!

*68 Newest TEST INSTRUMENTS*



*25 Modern P.A. SYSTEMS*



*It's New!*  
*It's Different!*  
*It's Complete!*

**164 PAGES PACKED WITH VALUES**

Send for this great 1938 ALLIED Catalog today! It's new with Radio's latest 1938 developments!—It's different from any other radio catalog ever published!—it's complete with Everything in Radio! Everything you need in one great book—ready to ship instantly from ALLIED'S tremendous stocks—every item approved by Allied engineers for performance and value!

ALLIED's new 1938 Catalog shows you every type of test instrument—new 2" Cathode Ray Oscilloscope, tube-checkers, set-testers, analyzers, oscillographs, meters. All standard lines at lowest prices! See the new Build-Your-Own test instrument kits, including latest 20,000 ohms-per-volt equipment. Make ALLIED your one dependable source for radio service supplies!

New KNIGHT "Integrated" Sound Systems—every unit perfectly matched! 8 to 60 watts—permanent, portable and mobile—for 110 Volt AC, 6 Volt, and Universal operation—P.A. for every need! New KNIGHT Intercom Systems—2-Way, Selective, and Super-Selective.

ALLIED buys in huge quantities and shares the savings with you. That's why ALLIED'S prices are always lowest—that's why thousands of Service Men, Radio Builders, Dealers Amateurs buy exclusively at ALLIED. You'll save time, trouble and money by doing all of your radio buying from the new 1938 ALLIED Catalog—Radio's Leading Supply Guide. Write for it!

Write for the great new 1938 ALLIED Catalog today! 164 pages, over 12,000 items, separate Radio, P. A., Service, Amateur-Experimenter sections. Radio's easy-to-read, easy-to-shop, easy-to-order—from book!



**ALLIED RADIO**  
**CORPORATION**  
**833 W. JACKSON BLVD., CHICAGO**

ALLIED Radio Corporation,  
833 W. Jackson Blvd.,  
Chicago, Ill. Dept. 3-J

Send me your FREE 1938 Catalog—Radio's Leading Supply Guide.  
 Send me Free parts lists for.....

Name .....

Address .....

City ..... State .....

Please mention SHORT WAVE & TELEVISION when writing advertisers

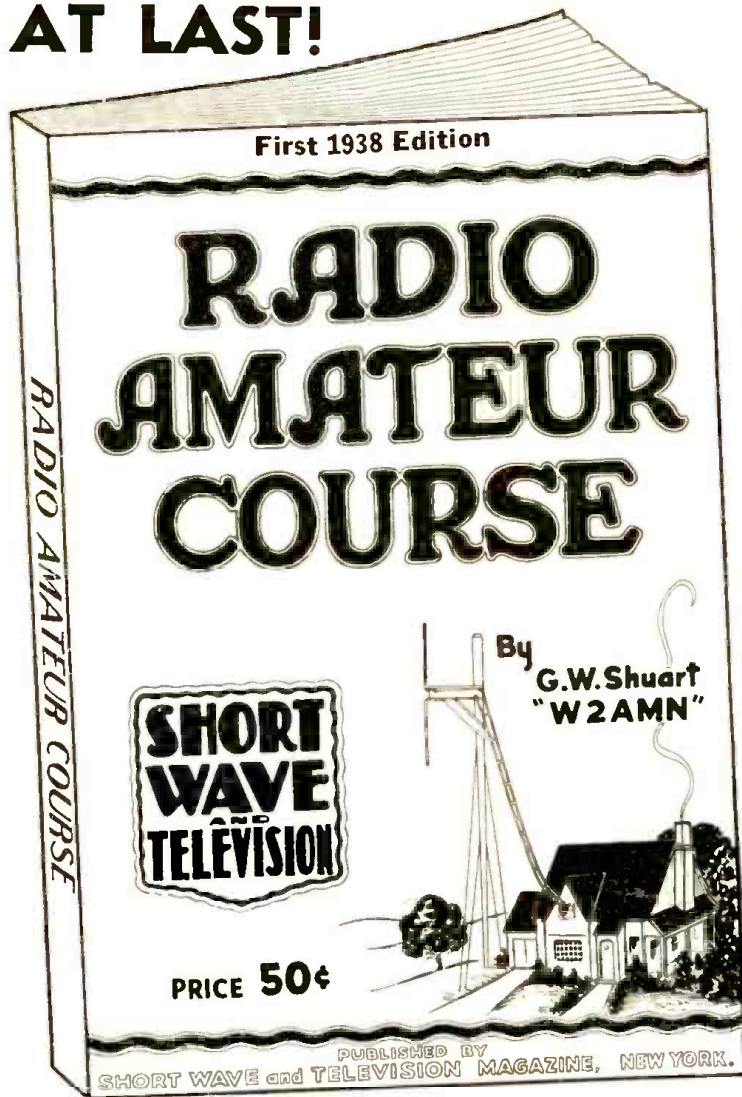

**AT LAST!**

*This is the book you have been waiting for!*

In the past few years we received thousands of requests from our readers in this and foreign countries urging us to issue a popular priced book that will describe in SIMPLE LANGUAGE the FUNDAMENTAL PRINCIPLES of short wave receivers and transmitters.

George W. Shuart, W2AMN, the author of this book, is well known to the short wave fraternity through the hundreds of outstanding *constructional articles* that appeared in SHORT WAVE CRAFT and SHORT WAVE & TELEVISION during the past five years. His articles have been frequently reproduced by many foreign magazines.

Through the "Question Box," edited monthly by Mr. Shuart in SHORT WAVE & TELEVISION, *thousands of problems* are solved for our readers. He knows what information is needed in order that they may have a thorough working knowledge of the art of Short Waves and thereby obtain the greatest enjoyment from their hobby.

No other book heretofore published contains so much valuable data, diagrams and illustrations.

This book covers EVERYTHING—from the theory of alternating current electricity to the complete short wave transmitting and receiving apparatus.

The book is now being printed and will be completed September 1st and shipped to thousands of chain, radio supply and book stores in time to make certain that when you call for your copy on September 15th, *it will be banded to you.*

If your dealer does not have the "Radio Amateur Course" in stock by September 15th, please send us his name and address or you may order from us direct and shipment will be made immediately.

A new book that will appeal to tens of thousands—  
An essential book for all beginners—  
The foundation of a radio education.

An outline of some of the chapters in this BIG book

- Alternating Current
- Resistance, Inductance and Capacity
- How the Vacuum Tube Works
- Vacuum Tubes as Regenerators and Oscillators
- Class A, B and C Amplifiers
- The M.O.P.A. Transmitter
- The Fundamentals of Amplitude Modulation
- The Selection of Tubes in the Low Power Exciter Stages
- Power Supplies for all Amateur Needs
- Antenna and Feeder Systems
- Bandspread, Regeneration and Methods of Coupling in Receivers
- A Discussion of Superheterodyne Circuits
- Ultra High Frequency Receivers—Simple and Advanced Types
- Ultra High Frequency Transmitters—All Types
- The Construction of Transmitters and Receivers
- Remote Control Circuits for Transmitting Stations
- Learning the Code
- Extracts from the Communications Act as pertaining to Amateur Radio

**THIS BOOK DESERVES A PLACE IN YOUR LIBRARY**

**SHORT WAVE & TELEVISION, 99 HUDSON STREET, NEW YORK, N. Y.**

Please mention SHORT WAVE & TELEVISION when writing advertisers



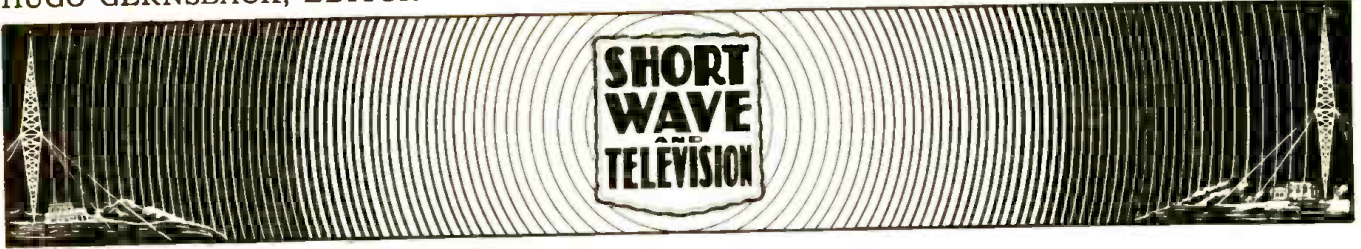

# Mechanical Scanning for Television

By William Hoyt Peck,  
President, Peck Television Corporation

● FIVE years ago the public was told that television was "just-around-the-corner." Today, they are told approximately the same story—and it is beginning to wear a little thin. As a matter of fact, television is actually here and has been here for some time. As this is written, I confidently expect that one form of television at least will be before the public within sixty days. This is a Television news service which displays news bulletins and similar material in type or other characters moving across a screen.

However, the idea which most people have of television is moving images similar to talking motion pictures. These, indeed, exist in the laboratory and have existed there for several years. The chief problem in making such forms of entertainment public is to finance stations and programs. There is a vicious circle; the public cannot be expected to buy television receivers in any quantity, unless they are assured of excellent programs of reasonable diversity and certain to continue for a number of years. Nor can broadcasters be expected to invest tens of thousands of dollars in transmission equipment, unless they can be assured of an adequate revenue from program sponsors. Such sponsors, in turn are likely to be reluctant to make any large expenditures such as are necessitated by first-class programs, unless they can be assured of a large listening and looking audience, which brings us back where we started. These problems will doubtless be solved and I feel confident in saying that the solution will come within approximately 18 months.

There are two major systems of television between which the public will possibly have to choose. For that reason I should like to express my opinion of the systems which will doubtless compete.

In the cathode ray system, light source, modulating means, scanning means, and screen, are contained in a single tube, whereas, in the mechanical system these must be separate elements. At first glance it would seem the cathode ray system, due to its greater simplicity, was superior for manufacturing operations. Further examination, however, shows this not to be the case, for in order to control the cathode ray tube sweep circuits are necessary, and such sweep circuits require the use of numerous additional resistors, condensers, chokes and tubes. It is a fact that the more successful cathode ray receivers of today employ upwards of 30 tubes. Compare this with the mechanical

systems, which need no more than 9 regular radio tubes. Further, excessively high voltages comparable with those used in the electric chair at Sing Sing, are necessary to operate a cathode ray tube in order to secure a sufficiently large and brilliant image. Not only is such a voltage dangerous to human life, but it is also expensive, in that it requires more heavily insulated apparatus throughout the power pack.

Mechanical systems, like those in which I am interested, for example, derive light from an automobile headlight bulb working on but 7½ volts. No voltages in the receiver need be greater than those commonly employed in standard broadcast receiving sets.

The factor of size of image is another point which must be considered. A cathode ray tube producing a 5" x 7" picture must be approximately 9" in diameter and 17" in length. While 8" x 10" pictures and even larger ones have been broadcast, I consider it doubtful that tubes could produce images of home-movie size, or that images 2 x 3 ft. can ever be broadcast commercially, unless a small projection tube working at tremendous voltage is used. This obstacle is not met with in the mechanical system, for it is unnecessary to use any different equipment or higher voltages to produce an image 2' x 3' or larger.

As to detail, the size of the scanning spot remains constant in the mechanical system, while it doubles its size when in the cathode ray. For this reason, a 220 line mechanical system affords detail which is the equivalent of 441 line cathode ray pictures. The mechanical system is also more flexible; if a cathode ray receiver is factory-adjusted to receive a 441 line, 60 frame image, and if the user desires to receive images composed of any other number of lines per frame, or frames per second, it is a lengthy job for a technician to re-align the sweep circuits in order that this may be done.

In the mechanical scanning system as developed in our laboratories, a self-synchronizing multi-speed motor is used. A component of the signal received is fed into an amplifier which incorporates a grid-glow relay. Thus the speed of the motor is regulated to scan the incoming signal perfectly, irrespective of number of lines or number of frames. There is no reasonable limit to the number of lines or frames which the mechanical system is capable of handling. We will have no difficulty in (Continued on page 270)

*Ninth of a Series of "Guest" Editorials*

**SHORT WAVE & TELEVISION IS PUBLISHED ON THE 1st OF EVERY MONTH**

This is the September, 1937 Issue.—Vol. VIII, No. 5. The Next Issue Comes Out September 1

SHORT WAVE & TELEVISION, *Published monthly at Mount Morris, Ill.*

EDITORIAL and EXECUTIVE Offices, 99 Hudson St., New York City



## New "Electron Gun" Projects Large Television Images



Dr. Law of the RCA Laboratories views a Television image projected by his new "Kinescope."

screen. This is so brilliant that a simple optical system will project it onto a large screen. A projected picture 18 x 24 inches compares favorably in brightness with home motion pictures. In the demonstration, a picture 3 x 4 feet in size was shown, which was bright enough to be seen by the audience of several hundred engineers.

The principal feature of the demonstrated device is a new type of "electron gun," developed by Dr. Law and a group of associates in the RCA laboratories at Harrison, N.J. The gun is the structure in a television receiving tube which focusses flying electrons into an extremely slender beam. In projection, it is necessary to start (Continued on page 252)



Dr. R. R. Law points to a newly developed "Electron Gun" in the new "Kinescope" for projecting Television images.

● NEW television projection tubes capable of reproducing televised scenes brightly on a relatively large screen were described before the *Institute of Radio Engineers* in New York City recently by V. K. Zworykin, W. H. Painter and R. R. Law of the Radio Corporation of America's laboratories. Dr. Zworykin and Mr. Painter disclosed that present achievements with such tubes result from research directed to this end and which has been carried on for years. A demonstration by Dr. Law came as a highlight in a symposium of technical reports on the status of television by RCA scientists, whose laboratory work along with the experimental field tests now in progress in the New York City area are vital parts of RCA'S television program.

The tube, which is about eighteen inches in length, produces an image about 1½ x 2¼ inches on its fluorescent

## "Ghost Echo" Detector • • To Reduce Plane Crashes

● MUCH has been said and even more has been written about the constant danger to *air-traffic* caused by mysterious radio "ghost echoes." No one has been able to find where they come from and where they go to; and the number of airplanes which have crashed to pieces has by no means decreased. Not only has America been alarmed by the increasing number of air-crashes, especially during the time of sunset and sunrise, but European aviation has also experienced similar accidents in increasing number.

Science, which does not believe in supernatural things, started to search for the real nature of these "ghost echoes" and the results of the research work here and abroad has

disclosed some very interesting facts, which not only concern radio-communication between airliners and ground stations, but also short-wave transmission in general.

According to the experiments and the ensuing conclusions, this disastrous radio phenomena (often referred to as *ghost echoes*) is by no means of supernatural origin, although it has not been proven, nevertheless it may be stated with a fair degree of accuracy, that solar flocculi eruptions (whether visible or not) are the initial cause of the widespread impairment of any type of radio transmission. In addition to this generally observed effect radio transmissions especially on the higher frequencies are influenced to a considerable degree by the exposure of the so-called Heaviside Layer to light rays from the sun, and during the daily periods of *sunrise* and *sunset* these two factors cause especially strong disturbances in the *straight* or *reflected* path of transmission. The much commented upon "ghost echoes," although they caused ghostly accidents, are of a clear physical origin, and (Continued on page 256)

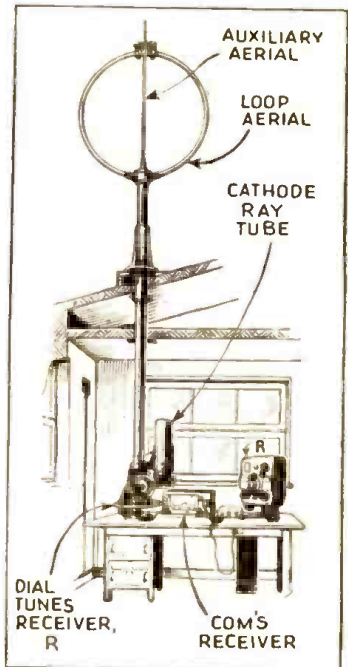

"Ghost Echo" detector set-up. This apparatus distinguishes between the desired signals and the "ghost echo" by means of a cathode ray tube.

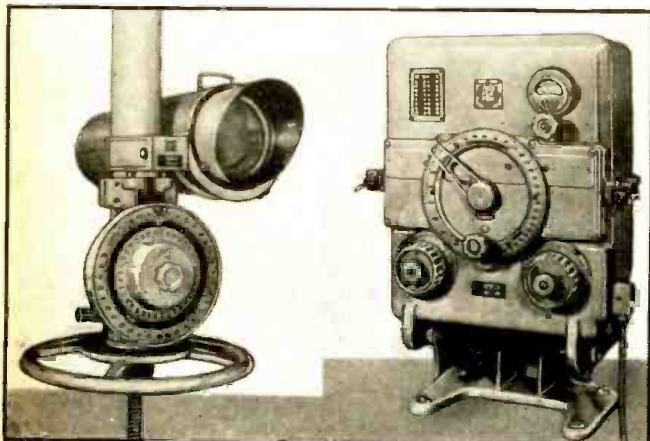

Left—Cathode ray indicator and below it, the tuning dial for the "ghost echo" receiver shown at the right.



# SHORT-WAVE PICTORIAL



Edward Startz, probably the most famous short-wave announcer in the world. He speaks seven languages and frequently makes announcements in all of them. Mr. Startz's voice is heard from the well-known P11011 short-wave station at Eindhoven, Holland. This station will soon have a new transmitter in operation

The latest television and short-wave events in various parts of the world have been caught in the camera's eye by our roving reporter.



Elizabeth-Ann Tucker, who is now in charge of the Short-Wave Program Activities of the Columbia Broadcasting System. Although not an engineer, Miss Tucker is none-the-less familiar with engineering technique and has, as she describes it, "a layman's knowledge of short-wave radio broadcasting." She has traveled extensively and has first-hand knowledge of what people in foreign countries would like to hear via short-wave from the CBS short-wave transmitter, W2XE.



Lowell Thomas, internationally known radio commentator, is here shown being televised at the NBC television studios in New York City. Shortly, our radio audiences will have the satisfaction of "seeing" their favorite news commentator and other entertainers, and will not have to be satisfied with simply hearing their voices. "Spot News" flashed by television will be extremely thrilling as the listener frequently will be able to see the actual scene being described at the moment.

Conchita Ascanio, the beautiful "Radio Caracas" artist often heard by North American short-wave listeners. Miss Ascanio is a born comedienne and she is as well the possessor of a lovely soprano voice. Her interpretation of "Dona Carmen" in the radio feature "Don Lisandro y Dona Carmen" has endeared her to Venezuelan radio listeners.



Amelia Earhart is here shown with E. Jay Quinby of the Western Electric Company who supplied the radio equipment for her powerful plane. This photo was taken before the start of her "round-the-world" flight. The radio sets are installed in "out-of-the-way" corners and only the tuning controls and switches are mounted in the pilot's cockpit; these controls being centralized in the small unit which Miss Earhart is holding in her hand.

Left—Here we see a Hollywood group inspecting the latest invention of the well-known radio pioneer, Leroy J. Leishman. The device is a special tuning dial which Mr. Leishman is here shown explaining; it enables both the television image and sound dials to be moved to the correct settings by pressing a single lever. In the photo we see Lloyd Corrigan, movie director; Jean Rogers, actress; Mr. Leishman, the inventor, and Boris Karloff, actor.



Right—The Farnsworth Television transmitter installed in their laboratory located at Philadelphia.

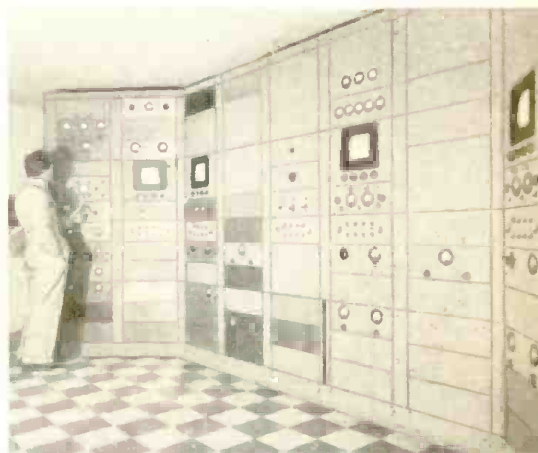



# The SPITZ Flight Recorder

By Mae Noble Rineman

Flashing lights on ground station map trace flight by short-waves radiated from plane.



Dr. Samuel Spitz has invented a new system for tracing planes in flight by means of an elaborate illuminated map located in the ground station. The small map to which Dr. Spitz is pointing, is used for tracing the plane by flashing lights as it comes into the local airport zone.

● FINAL extensive tests of the Spitz Flight Recorder, invented by Dr. Samuel Spitz, at his laboratories in Burbank, Los Angeles County, established the fulfillment of modern aviation's dream—charting an air transport's continuous progress through the skies.

Dr. Spitz's now-famous marine depth sounder achieved its purpose and became standard equipment on all navy and merchant ships, and so may his Flight Recorder carry out its purpose in eliminating major airplane disasters.

One of the greatest needs in commercial aviation today has been for some instrument or series of instruments by which a plane's flight might be accurately and continuously checked on the ground and the pilot directed to insure maximum degree of safety; also for the pilots as well as transport operators to have a positive means of recording their location at all times, on the ground ports.

Test flights covering the four hundred miles between Los Angeles and Oakland, California, were accurately followed by the Flight Recorder at the Union Air Terminal in Burbank. Its field of activity is 100 miles wide. By measuring and recording radio waves, the Recorder established the precise direction and distance of the test plane from its port. Through spots of light projected through the translucent map created by Dr. Spitz, the plane's movement was charted by the lights jumping steadily along the strip map of the airway lane, altering their speed as the plane altered speed.

When the ship returned to within eighteen miles of the Union Air Terminal, its charted movement was transferred to the round "landing map" which shows the topography of the terrain in an eighteen-mile radius, and progressed on a scale of one light to the mile until the center of the map was reached and the plane landed safely.

Short-wave radio impulses sent from a small portable transmitter with a high frequency oscillator in the cockpit of the plane influence the movement of the lights on the air terminal control map. As it nears the port, the ship emits stronger radio waves.

With the Flight Recorder in operation, should a plane vary from its proper course, this fact is promptly recorded at the ground station. The operator there, in short wave radio communication with the pilot can at once direct him back to the course. By checking the map the operator is able to keep the pilot advised at all times as to the nature of the country over which he is flying, the altitude necessary to safe progress, and such other information

as is important to the pilot in the safe conduct of his flight.

Should a mechanical difficulty occur that makes it necessary for the pilot to make a forced landing before reaching his destination, the light on the map indicating the plane's position will not change. Within two minutes it will be known at the airport that the plane is down within a very limited area, and relief can be dispatched immediately for that spot. Should the landing result in wreck of the plane, even though the transmitter aboard may be completely destroyed, the Flight Recorder has been so perfected that the light on the map will not go out.

The accompanying pictures illustrate to some degree the maze of powerful tubes, miles of wiring and many intricate coils which comprise the ground apparatus of the Flight Recorder. Behind the huge (Continued on page 258)

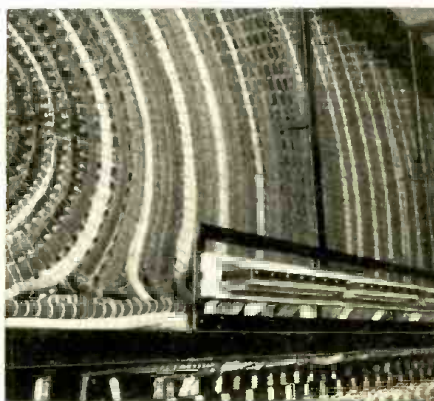

Back view of illuminated board showing intricate system of wiring.

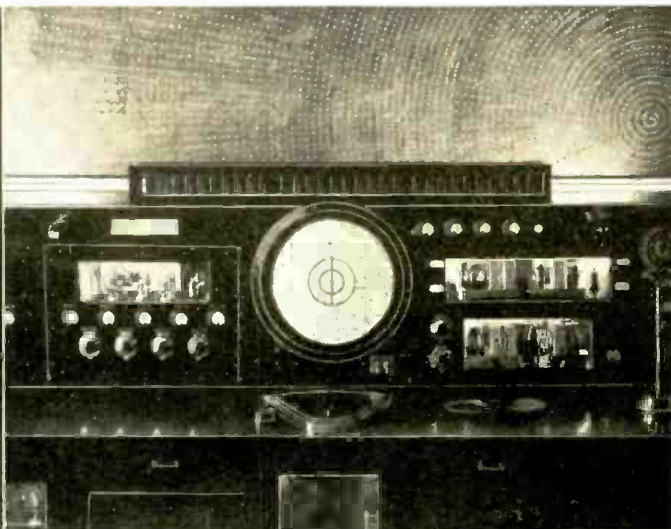
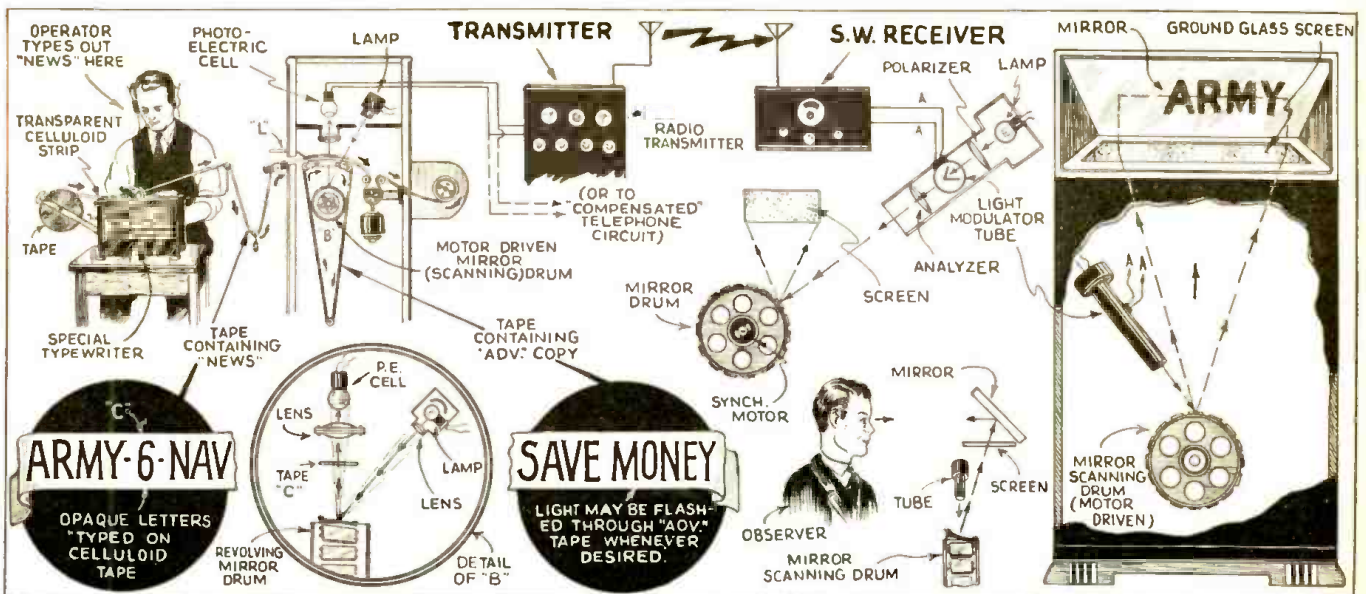

Photo at left shows radio control board for the Spitz Flight Recorder. The directional coils are seen mounted on top of the Binaural Selector, at the right of the picture. Landing map is seen in center of panel above the "divergence" wavemeter. Right hand photo shows panel-board with map removed and the elaborate system of lights that progressively flash the plane's course behind the map.





The general plan for distributing "spot news" by television or wire is shown above. The news is dispatched to the one or more receiving points by means of a special typewriter, which prints the characters on a cellophane tape. The words are scanned as the tape passes before a mirror-drum and photo-electric cell, the scanning process being repeated at the receiver.

# "Spot News" Transmitted by TELEVISION

By Robert Oakhill

● ODDLY enough, the first commercial appearance of television will apparently not be the programs of entertainment which fiction writers have imagined, but instead will consist of news flashes, headlines and bulletins, sent out either by radio or over standard "land lines" similar to those used in broadcasting networks.

The apparatus to make transmission and reception of such material possible has been perfected in the laboratories of the Peck Television Corporation in New York City, and an independent company has contracted to take over the gathering and dissemination of news, and the rental of receiving equipment to key locations.

Here is the very latest method of flashing "spot news" to the public—via television! Advertising items can also be woven into the "news" report.

the transparent portions, but is blocked by the opaque ink of the typed letters as it passes to the photo-electric cell at the upper part of the cabinet.

The output of this cell is connected to a pre-amplifier, which may be used directly into wire lines, or to actuate a radio transmitter.

The signal, sent in either of these ways, is picked up by one, or any number of, receivers. There the signal is detected and amplified, then fed into a special light-modulator cell, which modulates the beam coming from a second automobile headlight bulb and passing through the cell on its way to the scanning disc, which also is provided with re- (Continued on page 250)



William Hoyt Peck, inventor of the latest "spot news" distributing system, watching a "televised" news item as it travels across the "screen."

Images consisting of moving letters in a strip six inches tall by three feet wide are produced on a screen that may be as much as seventy miles away from the typewriter where the messages originate.

This typewriter looks much like a standard machine, save that its characters are 3/8-inch tall, and are written on a continuously moving strip of cellophane, instead of the conventional paper. An electric motor, automatically stopped and started, is built as an integral part of the typewriter, causing the transparent tape to move one space each time a letter is struck, without need for carriage return.

From the typewriter, the tape is fed into a transmitter cabinet, which is about the size of a four-drawer file. At the back of the cabinet, there is an automobile headlight bulb, the light of which is concentrated and focussed onto a scanning disc, where reflecting lenses, patented by William Hoyt Peck, president and chief engineer of the corporation, cause the beam to scan the moving tape. The light passes through

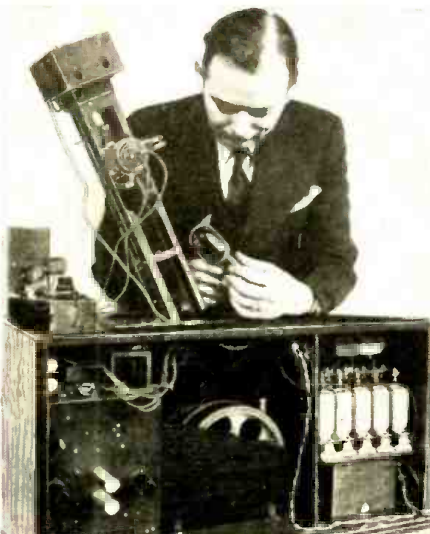

J. Francis Dusek is shown examining one of the Peck "light-modulator" cells; the multi-mirrored scanner appears below in the cabinet, and the S-W receiver at the right.



An engineer is shown in the act of checking the 6-volt exciter lamp on the transmitter. The short-wave transmitting panel is shown at the right of the photo.



# Short-Wave Transmission and The IONOSPHERE

By A. G. McNish

Department of Terrestrial Magnetism, Carnegie Institution of Washington

● THE remarkable advances in radio science accomplished in recent years would probably have been very much retarded, except for one remarkable provision of nature—a region of the atmosphere capable of reflecting radio waves back to the earth. Although existence of such a region was suggested

The editors asked Mr. McNish to prepare this article especially for our readers, in view of the fact that the author has carried on a great number of experimental researches covering the phenomena of short-wave transmission; particularly the effects of sun spots, magnetic storms, etc.

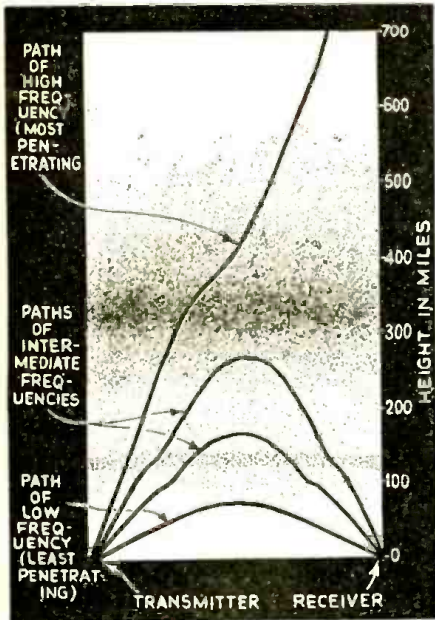

Figure 4—Paths of radio waves of different frequencies in the ionosphere.

over 50 years ago by the British meteorologist, Balfour Stewart, to explain certain facts of terrestrial magnetism, definite proof of its existence was not supplied until 1925 when Breit and Tuve in this country and Appleton in England performed their experiments on radio wave reflection. Since that time the earth's upper atmosphere, called the *ionosphere*, has been a fertile field for scientific research.

### Cause of Ionization

All scientific evidence clearly shows that radiations from the sun are the only important causes of the *ionization* which gives this region its peculiar electrical properties. At first thought of as a single region of ionization, it is now known that the ionosphere is highly *stratified*. A lower layer exists capable of reflecting only long waves, while higher are the F- and F<sub>2</sub>-layers, capable of reflecting shorter and still shorter waves. The reflecting power of these layers is determined by the number of electrified particles present, either free electrons or electrically-charged air molecules called *ions*. If the number of free electrons per cubic centimeter in a layer is high, then very

short waves may be reflected by it. For reflecting efficiency a single electron is equivalent to about 10,000 ions because of the much greater weight of ions. If the number of electrons per cubic centimeter in a layer is 1,000,000 then a wave of roughly 33 meters will be reflected back to earth at vertical incidence—that is, going straight up and straight down—while still shorter waves will *pass on through and escape into space*. However, such a layer is able to reflect waves three times as short, if the waves strike the layer at the oblique angles commonly involved in long-distance transmission.

These statements apply only for the highest parts of the atmosphere where electrons can move appreciable distances without colliding with molecules of air. Lower in the atmosphere where air molecules are more numerous, elec-

trons, set into vibration by the radio waves, strike against air molecules so frequently that they *waste all the energy given them by the radio waves, and do not reflect it back to the earth*. If the electrons are sufficiently numerous in such a region they waste all of the radio-wave energy and constitute an absorbing layer.

### The "E" and "F" Layers

It is now known that the E- and F<sub>2</sub>-layers of the ionosphere are due to ultra-violet radiation from the sun. Solar ultra-violet light striking the air-molecules sets electrons free in much the same manner as electrons are set free in a photo-electric cell.

A recent discovery, announced by Dr. J. H. Dellinger of the National Bureau of Standards, has opened the way for a considerable (Continued on page 253)

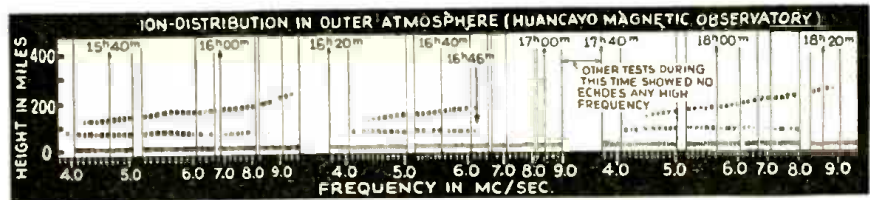

SPECTROHELIOGRAMS (MOUNT WILSON OBSERVATORY)

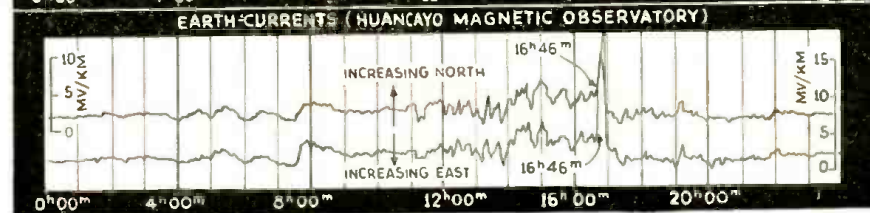
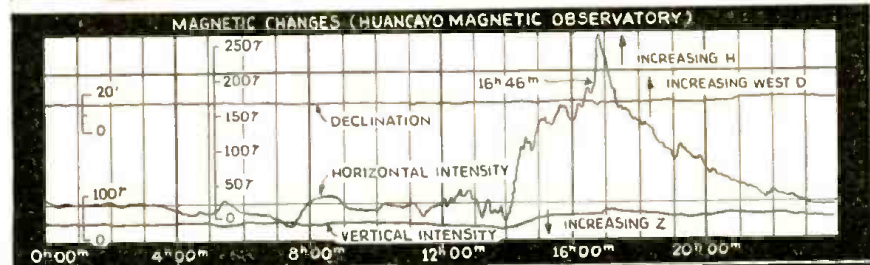
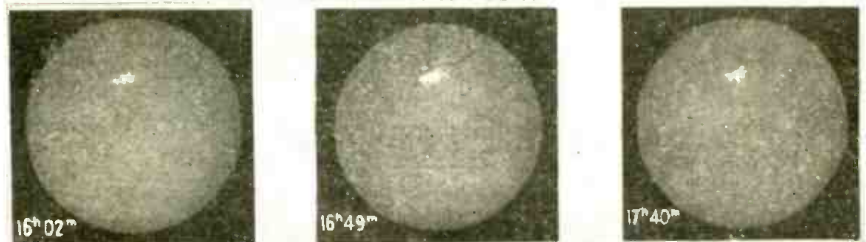

Figure 1—Magnetic, radio, and earth-current disturbances associated with brilliant solar eruption, April 8, 1936.





The B.B.C. Test Transmission visual announcement. This shows receiving tube rather too heavily biased, giving a very heavy black and white effect. Note how the M. & I. on E.M.I. are cut off, owing to the curvature of the receiving tube. Exposure three secs.

Tube biased rather too brightly for photographing two tones black and white. The general curvature and angle of the Marconi-E.M.I. are due to two effects, one, curvature of tube; two, local tuning circuits not quite adjusted to incoming synchronizing signal.

The tube biased to about correct brightness for ordinary viewing. Again note slight cut off in brilliancy of the I. in E.M.I. Note white edge on right of picture; this effect appears to be present in varying degree in all M.-E.M.I. pictures.

## How To Photograph TELEVISION IMAGES— Some of the Problems and Their Solution

● AMONGST all the publicity which the press in general has given to television very few attempts have been made to reproduce the image of the television screen and pictures which have been published show marked signs of retouching or faking. Photographers, professional and amateur alike, have tried to get pictures, but with far from satisfactory results.

One of the greatest stumbling blocks to the average photographer, who wishes to photograph a television image, is a complete lack of knowledge of how the picture is formed.

The photographer looking at a television screen of the cathode-ray type generally forms the opinion that there is a reasonable amount of light available to take a picture, which is true, but he is not generally aware of the fact that only a very small area of the scene is illuminated at any given instant, and that which looks like a well illuminated area is, in reality, only darkness.

Now to explain this more fully let us



This close-up of a cat's face was from a newsreel recently televised. In the original the scanning lines are most clearly marked. The mark between the eyes is a piece of faulty emulsion. Exposure 1/10 sec. F/2.9; hypersensitive plate.

inspect some actual figures, taking the Baird system first. This is a 240-line picture with a picture-frequency of 25 per second, that is to say a spot of light draws 240 lines across the end of the

cathode-ray tube, 25 times per second, the actual size of the spot of light, if everything is correctly set, being .000013 of the area (including synchronizing) of the television image.

Now let us see how much time is spent in drawing, say, one line. 240 lines are drawn in .04 second, therefore one line in .00016 second, and as there are the equivalent of 320 spots of light in one line the time taken for one spot to travel its own length is .0000005 second. Simply put, all this means is that if one opens a camera shutter for one second the actual time the photographic emulsion is exposed will be 25 short exposures of 1/2,000,000 second, that is to say, a total of 1/80,000 a second, which is not much compared with the usual photographic exposures.

In the Marconi-E.M.I. system, the period of exposure is less. In this system 405 lines are used on 25 pictures per second though the system of scanning is different. 202½ lines scan half the total area of the image in 1/50 of a second (Continued on page 257)



Elizabeth Cowell taken as she looked down to read announcement. Spots on nose and mouth photographic blemishes. This picture is another example of what can be done if the right moment is chosen. Exposure 1/10 sec. F/2.9 Kodak S. S. pan. film.



Leslie Mitchel, B.B.C. television announcer. Exposure half sec. F/2.9 Kodak super S. pan. film. The white shading where the black suite cuts the picture edge appears in most pictures on one of the systems of television.



Scene from "Marigold." Rather an imperfect result due to contrasting studio lighting and running the receiving tube with the general "brightness" too low for photographing. Original shows scanning lines. Exposure 1/10 sec. F/2.9 Ilford hypersensitive pan. plate.



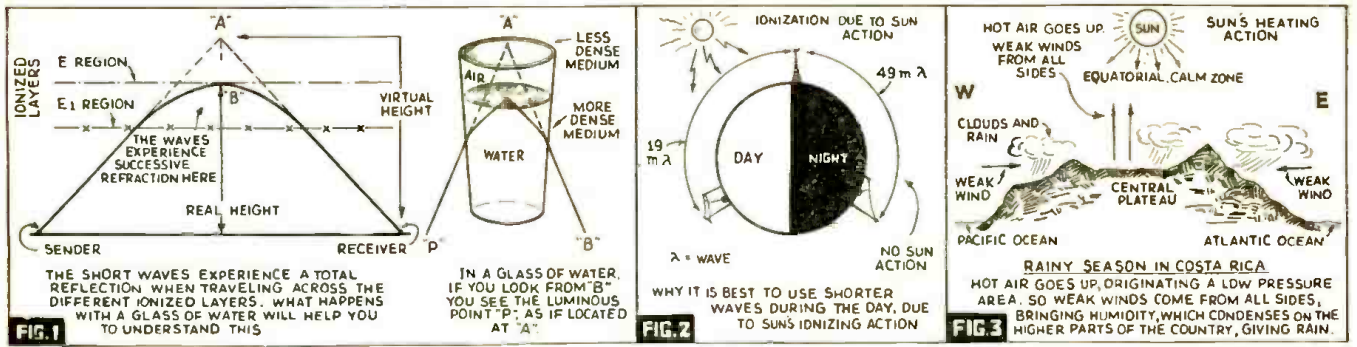

Diagrams above show region in which short waves are reflected; why short waves are best during day, and weather conditions during rainy season in Costa Rica.

# Weather Forecasting by Short Waves

By J. Merino y Coronado, (TI2JM)  
*Ex-Ass't Professor of Physics,  
 Liceo, San Jose, Costa Rica.*

● WHAT I have to say here with regard to weather forecasting by short waves is the result of actual experiments, and I am addressing my report in this case to the average "Ham" and also the "Fan," who listens to the short-wave stations, and who is interested in the great problems still to be solved by the meteorologists. I have purposely omitted therefore all involved mathematical analysis, but have presented the more practical aspects of the subject, so that those interested may have a chance to try and apply this latest development in short waves. The experiments and studies which I have made may be considered as a particular application in this part of the world, that is, Costa Rica, where tropical storms form rapidly and where it is important to know of their probable route as quickly as possible. At the same time, it is also to be pointed out that the general rules given have been followed successfully in other countries.

While I do not advocate this system as a substitute for known weather forecasting systems, I do believe that it will prove valuable as an additional aid in weather forecasting. This system should also prove extremely valuable in countries like Costa Rica, where the farmers do not have the benefit of a well-organized meteorological service.

### How Weather Affects Short Waves

To begin with, it is interesting to remember that, in general short waves

Describing the interesting experiments carried on in Costa Rica, Central America, by the author. An extension of this radio method of weather forecasting should prove very useful to weather experts in all parts of the world.

Thus we see that the propagation of radio waves suffer considerable changes under the action of all meteorological and cosmic phenomena capable of producing alterations in the atmospheric pressure, dielectric constant, conductivity and ionization. Just as we choose different wavelengths to suit different operating and weather conditions for everyday transmission between two points, we must also be able to listen to a considerable number of different wavelengths if we wish to make efficient weather observations. Some are best for daytime while others are better suited for night observation, due to the sun's action on the ionized layers of the upper atmosphere. See Fig. 2.

### Climate in Costa Rica

Let us consider for a moment the climate in this part of the world, Costa Rica, where the short-wave method of weather forecasting has been tried out with considerable success. The climate in Costa Rica, which is an isthmus, is essentially tropical and oceanic. We have a dry season from November to April, a rainy season from April to November, but this rainy season is divided into two parts by a short dry season when the sun is on its yearly travel; i.e., arriving at the tenth parallel (the latitude of Costa Rica).

While these climatic changes seem easy to understand, yet they suffer from powerful outside factors such as the cold northern (Continued on page 259)

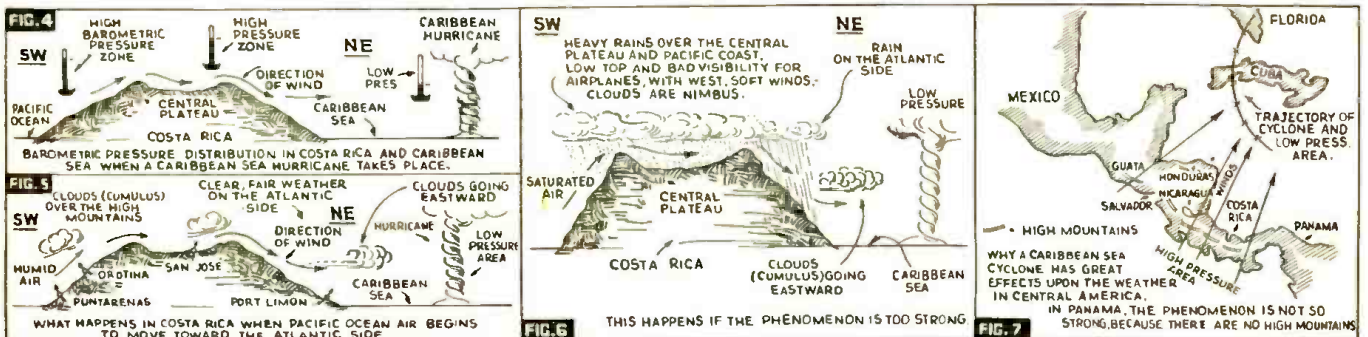

Above—Storm conditions in Costa Rica—What happens if heavily saturated air is blown north-eastward—finally, path of cyclone and low-pressure area with resultant effect on Costa Rica weather.



# WORLD-WIDE SHORT-WAVE REVIEW

-Edited By C. W. PALMER

## U. H. F. Super-Regenerator

● A SUPER-REGENERATIVE receiver designed for the ultra-short waves, and somewhat more elaborate than the usual type found in foreign magazines is shown in the sketch here, as reproduced from *Practical and Amateur Wireless* (London).

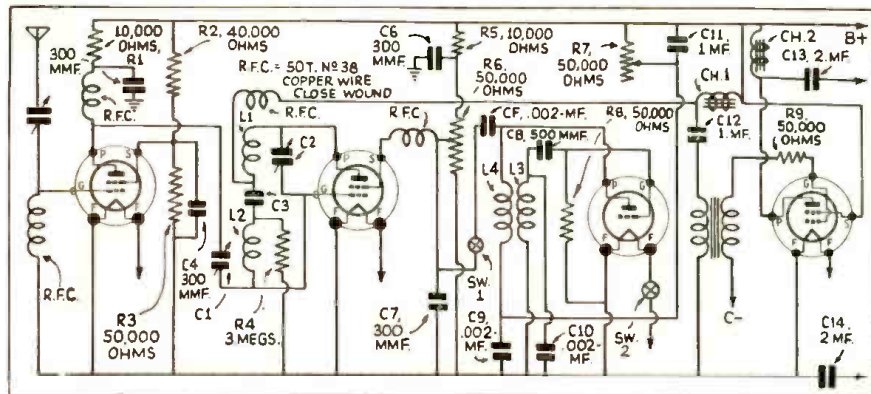

A novel super-regenerative hook-up for use on the ultra short waves is shown above.

As an examination of the hookup shows, the set contains a stage of aperiodic R.F. amplification before the detector and quenching tube. This R.F. stage is used primarily to prevent radiation of the receiver as well as to stabilize the response and to prevent swinging aeriels or other external conditions from affecting the response. However, it is also useful to some extent (depending on the frequency) as an amplifier.

The detector is the usual type of tickler regenerative detector which is "quenched" or made to super-regenerate by means of a low-frequency oscillator—in this case a separate tube. This detector and beat oscillator is followed by a stage of A.F. to increase the gain. Additional A. F. stages can be added as needed. In order to provide stable operation in this set it is necessary to shield each of the three "R.F." circuits—the R.F. amplifier, detector and quench oscillator. These should be enclosed in separate shield boxes.

The coil L3 of the quench oscillator should contain about 1,400 turns of number 38 enamelled wire while L4 should contain 900 turns. Both coils are wound on a 3/8-in. slotted form with about 1/16th inch space between the windings. Jumble winding can be used in making these coils.

The values of the remaining parts are indicated, with the exception of the detector tuning coils, which depend on the desired frequency range. About 3 turns of number 14 wire, 1/2-in. in diameter, slightly spaced, will be suitable for both L1 and L2 for the 5 meter band.

## Home-Made Recorder

● Automatic recorders for registering code signals on a paper tape have not

received much attention in this country, but in Europe they are quite popular. An interesting recorder was recently described in the *"T & R" Bulletin* (London). The diagram shows how the recorder is connected to the output tube of a receiver, which may be a superhet.

## R.F. Regeneration for a Short Wave Set

● IN an effort to make a regenerative set for short-wave reception which has more "pep" than the ordinary type, a radio set designer, writing in *The Australasian Radio World* (Sydney) has introduced regeneration into both the R.F. amplifier before the detector and in the detector itself.

This naturally increases the "gain" tremendously, but as might be expected, the set is extremely unstable, flying into oscillation at the slightest provocation. To eliminate this undesirable effect, a buffer amplifier is introduced between the regenerative R.F. stage and the regenerative detector tube.

Electron coupling is used in both regenerative circuits, as a means of making the set as stable and easily controlled as possible.

The circuit, shown here, gives the values of all the condensers and resistors. The coils, both in the aerial and the detector circuits are the usual tapped secondary type used in electron-coupled tuners. The R.F. tube is coupled to the buffer tube through a .001 mf. condenser and short-wave chokes are used to allow the proper voltages to be applied to the tubes, without loss of signal voltage. These R.F. chokes are important in the successful operation of the set, and they should be chosen with care. The value of inductance is not important as long as the chokes do not have any "holes" in the desired tuning bands.

The radio experimenter who wants a set which will really "reach out"—though it may not be the most simple to operate—should try this system of double regeneration. Using a properly arranged chassis to keep the coupling between the coils and grid and plate wires at a minimum, this set will "warm the heart" of any Ol' Timer.

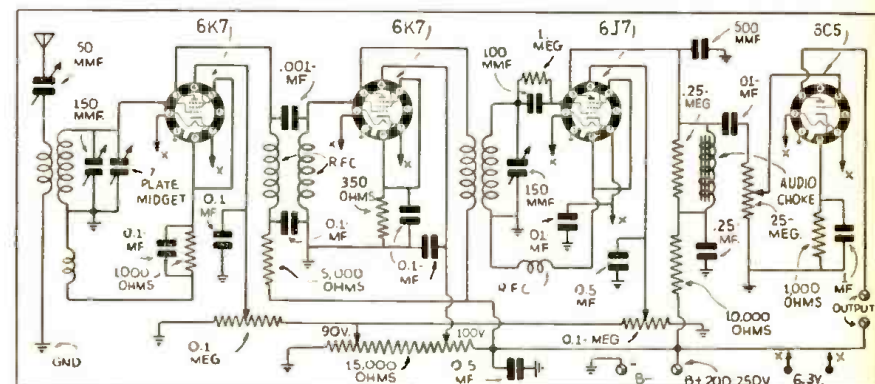

In this receiver regeneration is introduced into the R.F. amplifier ahead of the detector, as well as in the detector itself, with a considerable increase in "gain."

## \$25.00 FOR GOOD 1-TUBE SET

● THE editors know that our short-wave set-builders and experimenters must have developed some extra fine 1-tube circuits—possibly for receiving sets, short-wave converters, etc.

We are therefore offering \$25.00 for a good 1-tube set, either in the form of a short-wave receiver or a converter. Please note that there is little use in sending in an ordinary hook-up for a 3-element tube as most of the circuits possible with these tubes have been published.

What the editors want is a new circuit, designed around one of the latest type tubes having a multiplicity of grids. Refer to the March issue, page 675, where a very ingenious 1-tube S-W converter circuit is given. This will give you some idea of what we are after.

As a preliminary, you may send in a diagram and a description of the set and a good clear photo or two of it. A list of parts should accompany the description and the editors, who will act as the judges, and whose opinion will be final, reserve the privilege of requiring the set to be sent to them for inspection and test if they so desire. With the dual purpose tubes now available many ideas will suggest themselves. For example—Receivers with R. F. and Detector stages; Detector and A.F. stage; Detector and Plate-Supply Rectifier; 1-tube Super-het; Reflex set, etc.



# A · B · C · BEGINNER'S Short-Wave Set

By H. G. Cisin, M.E.

As the author points out, the beginner should start with a 1-tube set—the simpler the better. This receiver has regeneration and a simple coil arrangement, provided with taps, so that different bands can be switched in quickly and easily. It works on batteries and its low cost should commend it to every S-W "Fan."

The 1-tube Beginner's receiver here described is very easy to tune and can be switched from one band to another in a "jiffy."



● **HERE'S** a beginner's set which should help to create thousands of new short-wave "fans." Although it has an extremely attractive appearance, a glance at the top and the bottom views confirms the statement that it has been designed especially for the man without previous experience in set-building.

set. First of all, the set should employ only one tube and that, a very simple one—a tube having only the following elements—plate, grid and filament. For this reason, *battery* operation is preferable for the novice. Secondly, the receiver should have only a minimum number of parts—i.e., only truly essential components, leaving out the tricks, gadgets, automatic "doo-dads," mystic brains and eyes and all other luxuries tending to complicate the wiring or to add to the expense.

Thirdly, the beginner's set should be built on a wood or bristol-board chassis instead of on a metal one. Wood is easy to drill and provides insurance against short-circuits. On the other hand, metal requires special tools and if a bare wire happens to touch the chassis in the wrong place, this may be the cause of extra expense for burned out tubes or run-down batteries.

With the above three points in mind, the writer set about to provide a short-wave receiver for the *embryo* set-builder which would actually be "as simple as A.B.C." Hence, we offer you the "A.B.C." Beginner's Short-Wave Set.

All parts of this novel set are assembled on an 8½" by 11" wood or bristol-board panel, which in turn is mounted on two inclined plane wood side-supports which start from a maximum height of three inches. The popular 30 type tube is employed because of its

simple structure and low battery drain. It is of the two volt type, and needs only two 1½ volt dry cell "A" batteries and one 22½ volt "B" battery. This tube uses so little current, that the batteries will last for months under normal conditions. For added volume, more "B" batteries can be added, up to a maximum of 135 volts.

This circuit is of the "regenerative" type, which means that additional amplification is given to the output current, through the simple expedient of connecting an extra coil of wire, called a "tickler," in series with the plate and the earphones and placing this close to the tuned coil in the antenna circuit. This actually magnifies the strength of the incoming signals, and the experimenter can verify this for himself, by placing the set in operation and then shorting out the tickler coil with a piece of wire. The great drop in volume will be noticed at once.

The "A.B.C." Beginner's Set uses a coil of the solenoid type, wound on an air core. The secondary has a diameter of 2½" and a primary (not used) of the same size. The tickler, which is also air-wound, has a diameter of 1½". This latter coil is provided with a rotary shaft and when this shaft is turned by (Continued on page 261)

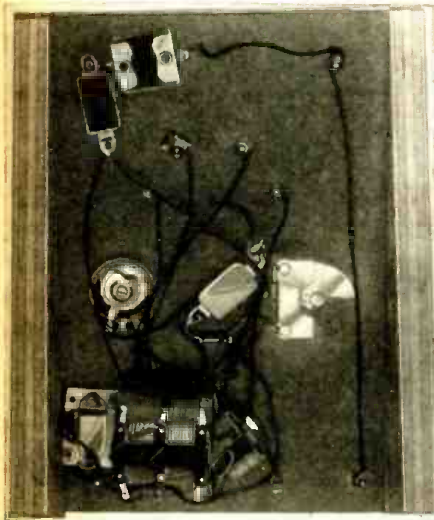

A bottom view of the Beginner's set—the wiring can be done in an hour, easily.

### Only 1 Tube Used

The following features, in the writer's opinion, are essential in every beginner's

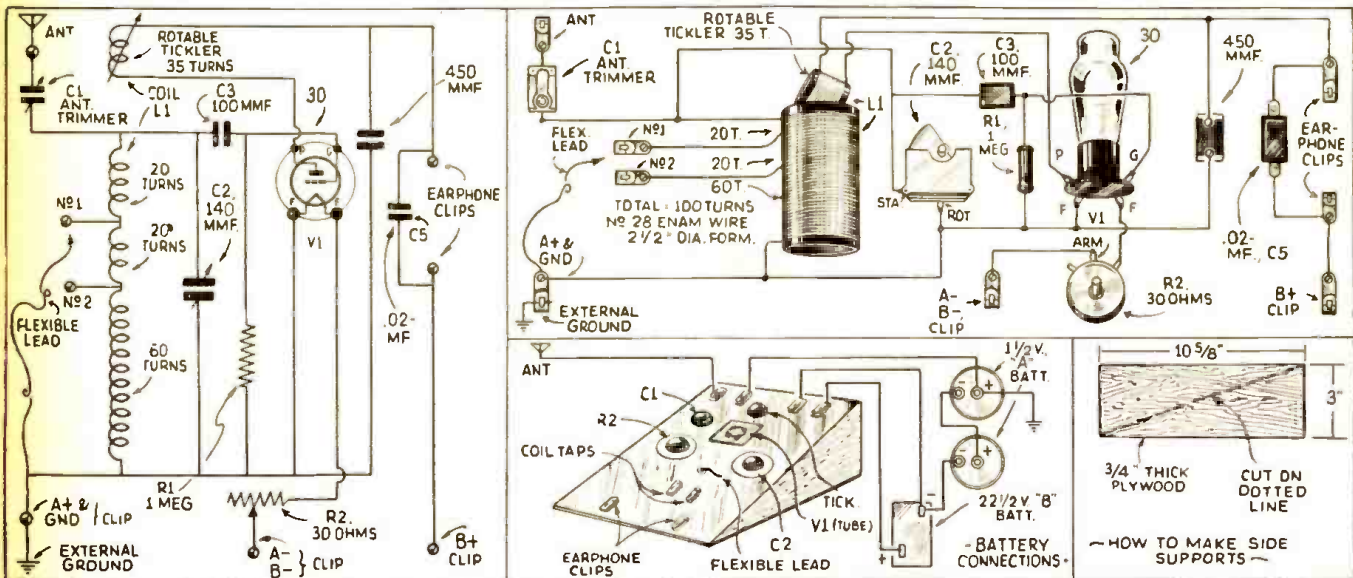

Schematic, as well as picture wiring diagrams for the Beginner's 1-tube receiver are given above, also battery connections.



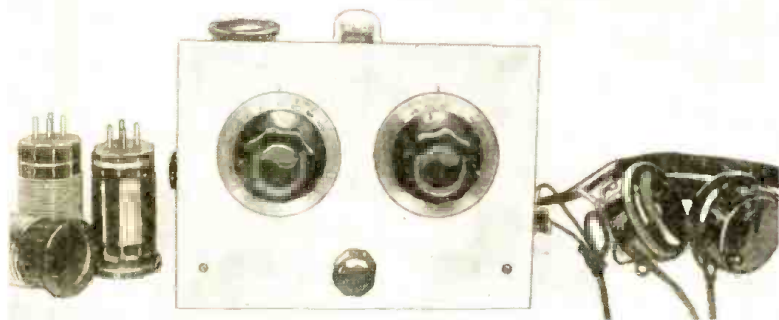

Here's a 1-tube receiver which will delight the heart of every short-wave beginner. The circuit is easy to follow and one tube performs the functions of two tubes. Band-spread is provided and with high quality parts very fine receiving results are assured. This is a "head-phone" set and it can be operated from batteries or a regular power-supply unit.

Front view of the 1-tube receiver which has numerous features, including a very smooth regeneration control and band-spread. Foreign stations can be heard swell on this set.

# For the BEGINNER . . . A Twin-Pentode Receiver

By  
G. W. Shuart, W2AMN

• WE have had twin diodes, twin triodes, and many other types of twin combinations of tubes, around which various receivers have been built by the short-wave experimenter. The tube engineers have now presented us with the 1E7G which is a twin-pentode battery type tube. This tube is similar to the type 33, except that there are two sets of pentode elements in the one couple.

Bearing in mind the excellent results thousands of readers obtained with the Twinplex receiver using the type 19 tube, we believe this set will be destined to attain great popularity, inasmuch as it provides considerably more volume than the one using the type 19.

The circuit diagram of the new twin-pentode receiver is essentially the same as the Twinplex, and should offer no difficulty in construction or operation to even the most inexperienced beginner.

Referring to the diagram we find that the conventional pentode detector circuit is employed, with plate feed-back for regeneration and a screen-grid potentiometer for controlling regeneration. The audio stage is resistance-coupled to the detector. However, should the experimenter desire to employ transformer coupling, one may be incorporated with a slight increase in over-all volume. The screen-grid regeneration control provides the smoothest operation, although it necessitated the use of quite a low voltage on the screen of the audio stage, due to the fact that the screen-grids of the two-tubes are connected in parallel within the tube, and are represented by a *single prong* in the base.

An alternative method for controlling regeneration would be in the plate circuit of the detector. This could be either in the form of a potentiometer or a variable condenser in place of the .0005 mf. fixed plate by-pass condenser, which is employed in the diagram shown. In this case the full 67½ to 90 volts may be applied to the screen-grids, although with higher voltage on the grids, the audio stage functions more efficiently but the detector tube is a little more awkward to handle.

We would advise that you follow the arrangement shown in the diagram,

with the choice of transformer or resistance coupling being left to the builder. These other methods of controlling regeneration are given in order

It will be noted that the suppressor of the tubes is connected to the negative side of the filament and not to the center, therefore, all grid leads are made to the negative side of the circuit to which is also connected the B negative. This provides no bias voltage on the grid of the audio amplifier and for operation with 90 volts on the plate, the bias battery does not seem to be necessary. However, with 135 volts on the plate the bias battery should be connected in series with the ¼-meg. grid resistor in the audio stage. This battery should have a value of 4.5 volts.

Returning to the regeneration control again for a moment, we find that the control has a switch attached; this switch is connected in series with the control and the connections are such that when the control is entirely off the switch opens. This is done to eliminate any drain from the 50,000 ohm potentiometer on the B batteries when the set is not in use.

Band-spread is provided by two condensers; one large one for bandsetting, and one very small for hand-spread tuning. By employing 15 mmf. for (Continued on page 248)

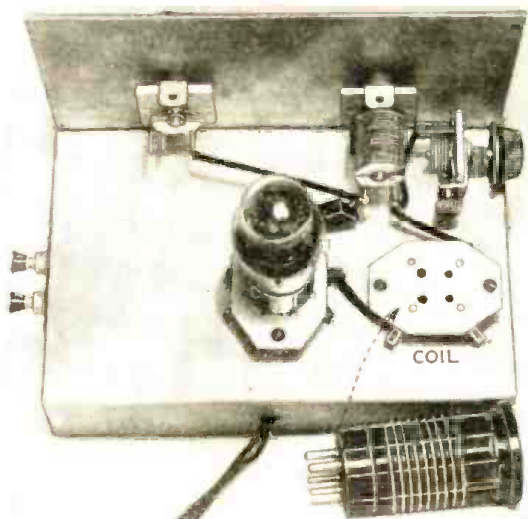

A rear view of the Twin-Pentode receiver showing "band-setting" and "band-spread" tuning condensers, as well as the "antenna tuner" at the right.

to provide material for the experimenter who wishes to try different arrange-

ments. It uses but one tube, but has a number of valuable features including an extremely smooth regeneration control.

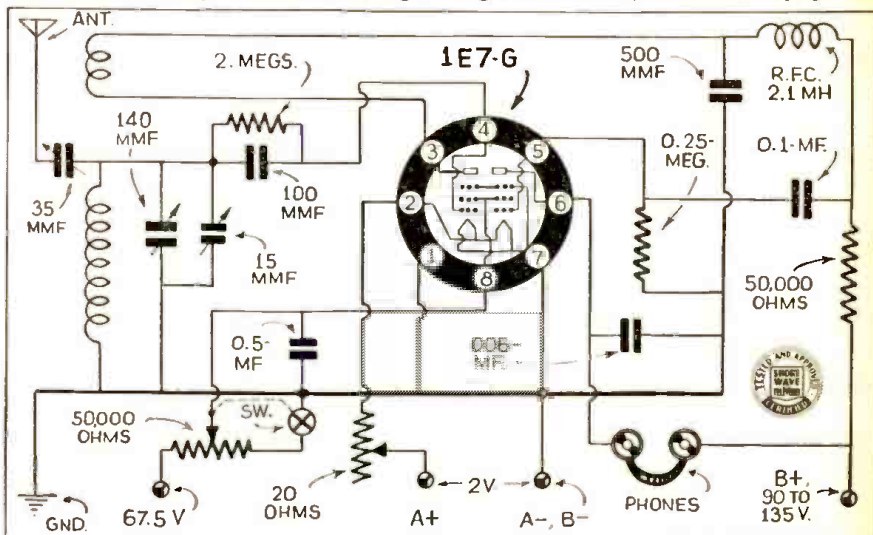

Wiring diagram of the Twin-Pentode receiver. It uses but one tube, but has a number of valuable features including an extremely smooth regeneration control.



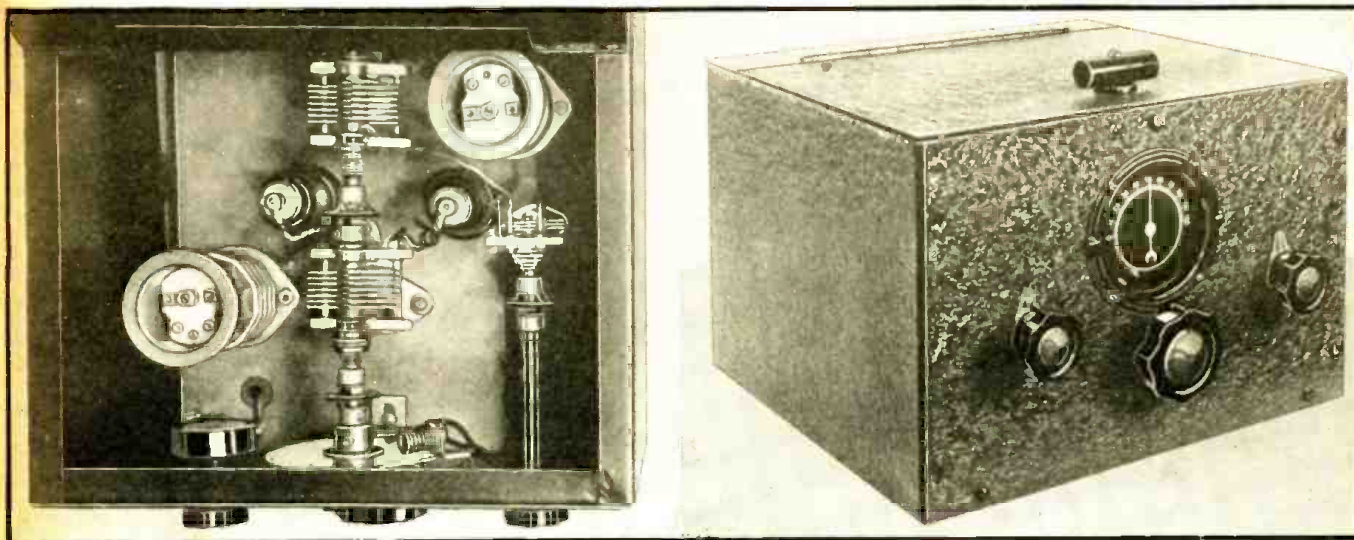

Front and top views of the short-wave "pre-selector."

## AN EFFECTIVE

By Raymond P. Adams

# S-W Pre-Selector

### The R.F. Stage

● THE radio-frequency stage in most *all-wave* receivers tunes rather broadly, in spite of the use of a high C. Both signal and image selectivity suffer, therefore, and especially if the tuned detector circuit is a similarly inefficient discriminator. The image gets through to beat with the high frequency oscillator signal and ride in on the I.F. no matter how efficient the intermediate circuits may in themselves be. Signal gain—and after all it's the business of the R.F. stage to provide such gain—is made poor in effect, and all the more so if the input circuit and tube do not provide proper amplification. Last and certainly not least, over all *noise-level* is made high.

If there is no R.F. stage then these effects become all the more noticeable.

### That "First Tube"

The first tube in any superhet line-up is the one which *must*, over and above all others, work at full gain efficiency. Noise voltages—caused by thermal agitation and random electron currents are generated within it and appear in both grid and plate circuits, to be amplified by all succeeding tubes and circuits. To these noise voltages are added those brought in via the antenna. And where will the signal be if it is not amplified to every possible degree in this tube? Why, *right down deep in the background mud!*

### The Tuned R.F. Circuits

In order to provide proper "gain" for the first tube, its own tuned circuit must be effective as a means of discriminating against undesired signals and im-

In this pre-selector two 6K7 tubes are connected in parallel, providing a noticeable increase in efficiency. To further this "gain" and to increase selectivity, both the input and output circuits are tuned. This pre-selector can be used with any short-wave receiver.

age. *Gain* is not entirely unrelated to selectivity. If one tuned circuit will not afford such selectivity, then two, perhaps three are in order. Whether or not additional input circuits use R.F. tubes sometimes doesn't matter—so long as they work to bring a desired signal not only *above* incoming background noise, but above heterodyne and general interference.

As we have stated, some superhets

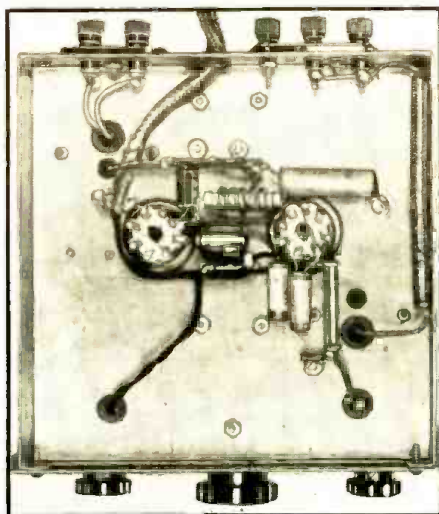

Bottom view of the pre-selector.

have no R.F. stage, perhaps no pre-selector circuits whatsoever. Thus their mixer tube is called upon to detect, to mix, and to provide inherent *gain* sufficient to bring the *signal-level* well above *noise-level*. Thus, too, their single-tuned cir-

cuit is called upon to afford the desired input selectivity. And it simply can't be done. Image and signal selectivity is not only poor, especially at high frequencies, but first-tube *gain* becomes entirely inadequate.

### Why a Pre-Selector?

Our last paragraph made it fairly apparent that an R.F. stage is necessary to effective performance in any superhet. No one will argue that a pre-selector isn't really advisable where the receiver is not equipped with such a stage. But is a pre-selector desirable where a receiver is so equipped?

The writer believes that it is, especially where the receiver is of switched coil all-wave construction, or where the instrument is used for serious "DXing" or amateur operation on high frequency bands, or where poor image and signal selectivity and signal-to-noise ratio have been demonstrated. There is no receiver in this man's world, for that matter, which will not perform more effectively when a *well engineered, high gain, selective* external tuned R.F. stage is added as a refinement. It cannot be too frequently explained that peak receiver adjustments, increased I.F. selectivity, and trick antennas may have much to do with the capturing of that elusive signal—but that a *highly selective and efficient* R.F. stage is, above all things, most contributive to satisfactory performance. (Continued on page 263)



# Hook-up and other details of Pre-Selector

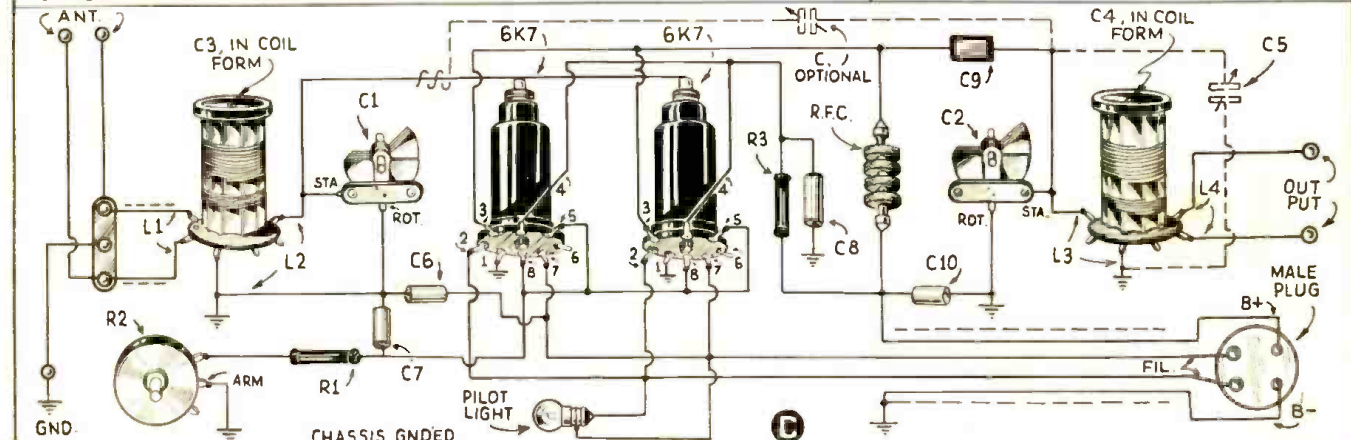
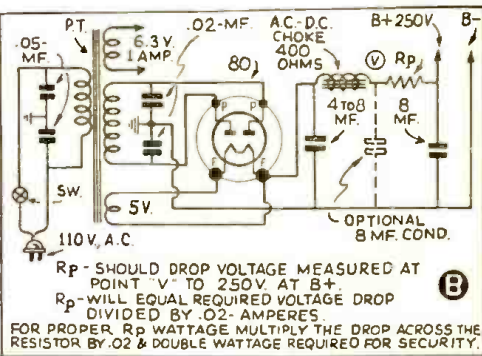
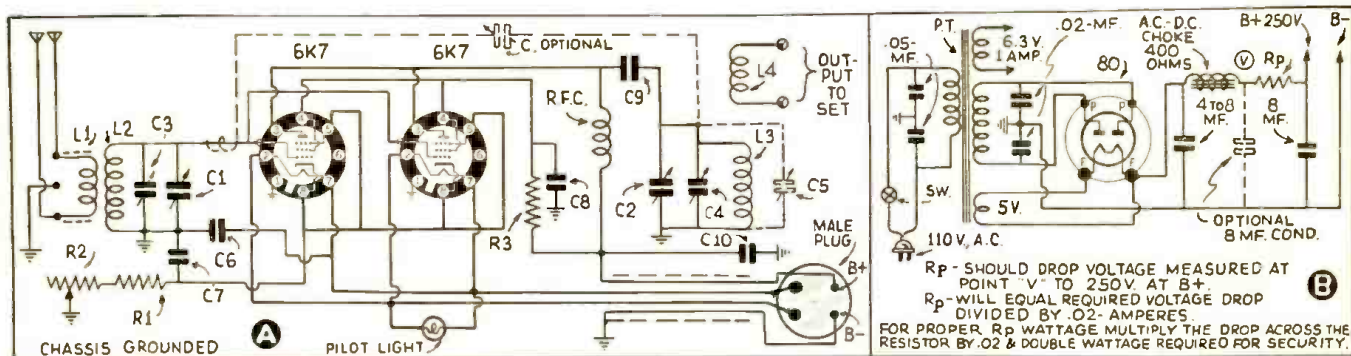

**COIL DATA AND CONNECTIONS**

COVERAGE IN METERS	L1	L2	L3	L4	REFERENCE LETTER
10-25	3T	5 1/2 T.	5 1/2 T.	X	A
25-50	5T08T.	11 1/2 T.	11 1/2 T.	X	A
35-100	10T.	20T.	20T.	X	B
100-250	10T.	50T.	50T.	X	B

L4: (X) NUMBER OF TURNS SHOULD BE DETERMINED EXPERIMENTALLY FOR PROPER MATCHING TO THE RECEIVER INPUT CIRCUIT.

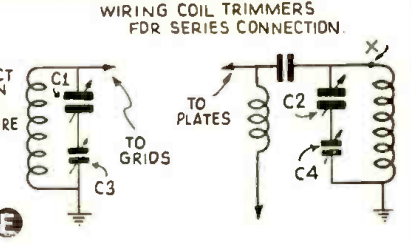
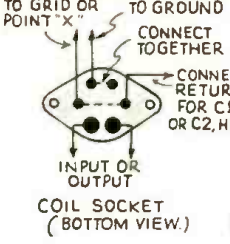
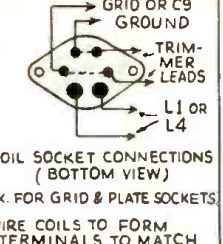

A: LENZ ELECTRIC SPECIAL NO. 20 INSULATED R.F. WIRE, CLOSE WOUND OR NO. 22 D.S.C. CLOSE WOUND FOR L1-L4, SPACED 1" FOR L2-L3  
 B: NO. 24 D.S.C. CLOSE WOUND

**D**

NOTE: -  
 ABOVE COVERAGE DATA REFERS TO COILS BUILT ON HAMMARLUND XP-53 FORMS AND WITH INSTALLED TRIMMERS AT MINIMUM CAPACITY SETTING IN PARALLEL CONNECTION. ANY INCREASE IN TRIMMER CAPACITY WILL LOWER HIGH FREQUENCY LIMITS.

Diagrams for the pre-selector described on the opposite page are given at the top. B in the upper right corner shows hook-up of power supply. Coil data and connection diagram are given at the left; optional hook-up for coil trimmers in series connection at the right. Chassis and front panel layout diagrams are given below.

C5 SHOULD BE MADE EXTREMELY SMALL, OR BE DISCARDED.  
 BOTH L2 AND L3 WINDINGS MUST BE ACCURATELY MATCHED FOR SPOTTING AND ALIGNMENT.  
 C3 AND C4 SHOULD BE ADJUSTED TO GIVE BOTH DESIRED BANDSPREAD AND PROPER TRACKING.

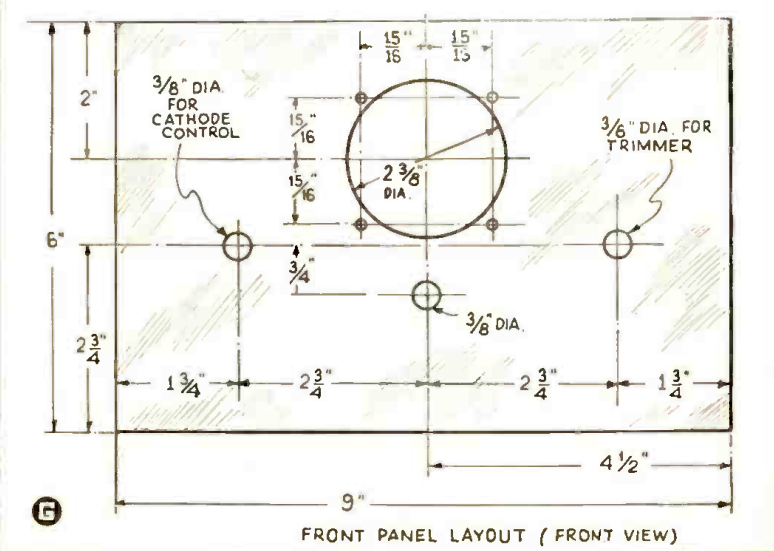
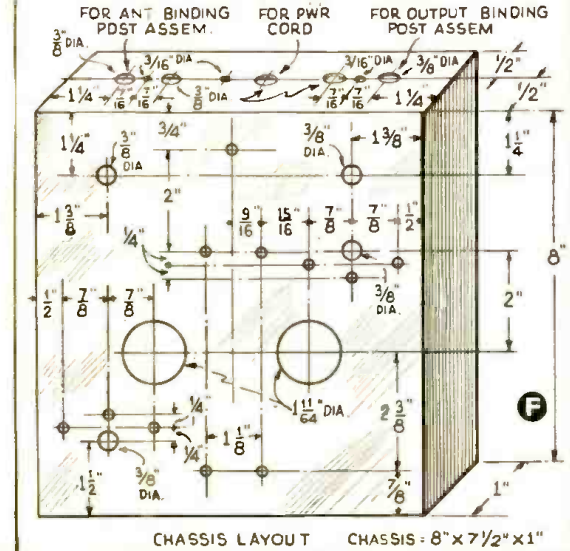





# 806 "ALL-

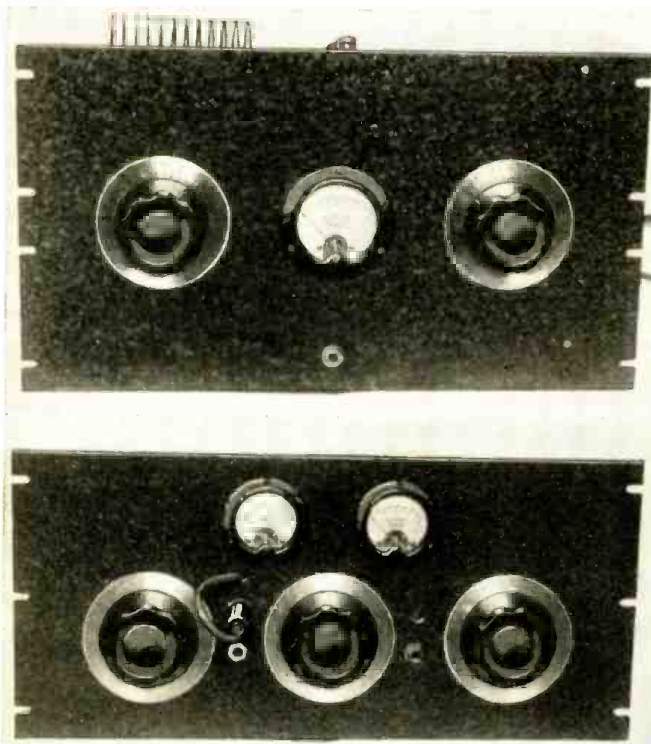

Front view of the complete transmitter. The "exciter" and "driver" stages are built on the lower panel and sub-base; the 806 "final-amplifier" and control panel being the top one.

● THE main purpose in the design of this transmitter was flexibility and simplicity. It is an easy matter to make an *all-band* transmitter employing a large number of stages. On the other hand, if proper tubes and circuit arrangements are employed, the problem is not quite so complicated as it may seem.

In transmitters having fairly high-power amplifier stages, that is somewhere around  $\frac{1}{2}$  kw., (500 watts) the *driver stage* should receive greatest care in the choice of components. The tube used as the driver determines whether or not the transmitter would be complicated. If the tube used in this position requires only a few watts excitation, then we can reduce the number of stages to three, providing we do not desire all-band operation with a single crystal. With this transmitter we have chosen the 804, which works exceptionally well down to 10 meters. The excitation requirements of this tube are extremely modest, less than 1 watt being sufficient for maximum output.

This very interesting transmitter employs an 806 as a final amplifier. Details of the exciter and driver stages are given; the exciter unit can be used as a 90-watt transmitter if desired. This transmitter has been tested "on the air" and has proven to be one of the "smoothest" operating rigs ever built.

### "Pen-tet" Exciter Employed

In order to obtain the utmost in flexibility, we resorted to the "Pen-tet" exciter which was described in the March 1937 issue of this magazine. This unit consists of nothing more than 6F6 pentode crystal-oscillator, followed by a 6L6 multiplier. This arrangement makes it possible to quadruple the crystal frequency with excellent efficiency. With 400 volts on the plates of the oscillator and multiplier, the output of the fourth harmonic and 80 meter crystal is more than sufficient to drive the 804 driver and it is necessary to adjust the coupling in order not to over-drive the large pentode. The 804 pentode seems to be the ideal driver for the 806 final amplifier used in this transmitter, as its output ranges from 50 to 80 watts, depending upon the circuit connections and the voltages applied to the tube.

### Excitation Requirement Is Small

In our case we used the Tetrode connection and applied 1,000 volts to the plate of the tube. The output with this arrangement was approximately 50 watts with an excitation requirement of only .65 watt. This output, of course, is slightly greater than the 25 to 30 watts required for the 806, when operated as a plate-modulated class C amplifier. However, the driver stage, especially in a phone transmitter should have *good regulation* and a *fair surplus of power*; proper excitation being obtained by *varying the coupling* between the driver and the final stage.

Since link coupling is used, a variation of the excitation is simply a matter of the proper placement of the link coil. The amount of grid current present in the final amplifier stage is the best guide to proper excitation adjustment. For class C telegraphy, the final amplifier grid current should be in the neighborhood of 25 to 40 mills. (M.A.) This can be obtained with a 15,000 ohm grid-leak.

Smaller values of grid-leaks may be used with lower voltages.

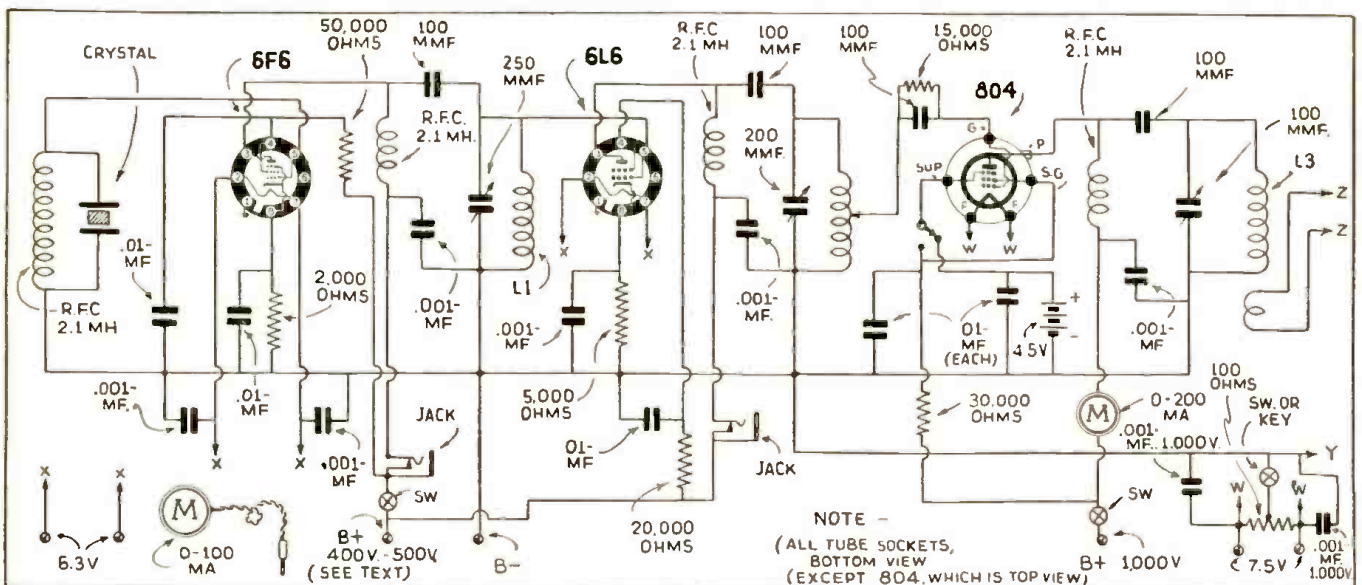

Complete Exciter Unit 50-to-90 watts; for operation of the exciter alone, the switch in the suppressor-grid circuit should be in the position which puts 45 volts on the suppressor.



# BAND" Xmitter Delivers 400 Watts

By George W. Shuart, W2AMN

### Phone or CW Operation

For phone operation, the grid current should be at least 40 mills, slightly higher values—not exceeding 50 milliamperes—may in some instances improve the linearity of the amplifier. For CW or code operation, the plate voltage to the final amplifier can run as high as 3,000 volts. However, for phone use, the maximum rating is 2,000 and this seems to provide the best all-around operation. These values will serve for the 80, 40 and 30 meter band. However, in some cases, it may be advisable to reduce the plate voltage slightly, probably to 1500 to 1800 on the final amplifier. Although we have operated the tube with 2,000 volts on 10 meters with no signs of ill effects, the manufacturers claim that for this service the tubes should be cooled, preferably with an electric fan. While this may be an inconvenience in some cases, should it become necessary, we believe that a slightly lower plate voltage would overcome the problem. The slight reduction on 10 meters would not be worth mentioning, insofar as actual service is concerned.

### Single Chassis for "Exciter" and "Driver"

The photographs show the general construction of the exciter unit, as well as the final-amplifier unit. The exciter and driver stage are contained on a single chassis and it can be seen that this is the same unit described in the March issue, except that the 804 is substituted for the 807 previously used. The panel dimensions are 8 3/4" by 19", while the chassis is 2" by 7" by 17". The chassis for the final stage is the same size and the panel is slightly higher or 10 3/4". The final amplifier tank condenser is of the split-stator variety and has a capacity of 50 mmf. per section. This unit originally was a 6,000 volt 100 mmf. condenser, the stator was later split. However, a standard split-stator condenser is readily available. For operation on the 80 meter band, this capacity is slightly small; we would recommend the use of a condenser having 100 mmf. per section if one is interested in high powered operation on 80 meters.

### Exciter Unit Can Be Used As 90-Watt Transmitter

Our suggestion is that the final amplifier be eliminated for 80 meter operation, and by applying approximately 45 volts to the suppressor of the 804, we have a 90 watt transmitter which should be thoroughly capable of meeting all requirements on the 80 meter band. In fact, this is the way the original transmitter was operated.

The high power final stage is only used on 40, 20 and 10 meters. The grid tuning condenser for the final amplifier stage appears to be a split-stator condenser of quite large

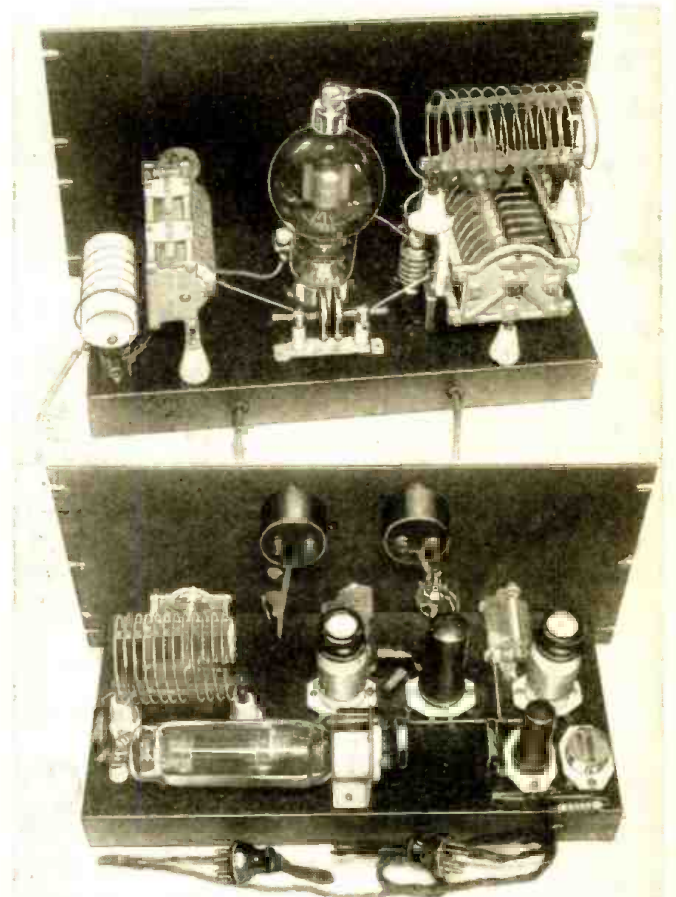

A peek behind the front panels—top, the 806 "final-amplifier," and below—the "exciter" and "driver" stages, with crystal.

dimensions. This was used in the first arrangement of the transmitter in an endeavor to employ a single-section plate condenser by the simple expedient of grid neutralization. However, satisfactory results can be more easily obtained with the split-stator condenser in the plate circuit, and a single condenser in the grid circuit. When using grid neutralization, the output of the driver stage, operated as shown in the diagram, would not provide sufficient excitation for efficient phone operation on the higher frequencies. Plate neutralization is shown in the diagram and eliminates this problem.

The complete transmitter as described, provides one of the smoothest operating "rigs" ever tried. Its excellent output of 400 watts on all bands provides an impressive signal.

### Coil Data

Coil data for the oscillator and frequency multiplier unit of the exciter may be found in the May 1937 issue.

The new data for the 804 amplifier is as follows: 80 meters—22 turns, No. 12, 2 1/2" diameter; for 40 meters 14 turns, No. 12, 2 1/2" diameter; 20 meter, 6 turns No. 12 2 1/2" diameter; 10 meter, 4 turns No. 12 1 3/4" diameter. These coils are of the self-supporting type with a length of 4". The 806 grid coils are wound on 1 3/4" dia. isolantite forms. The coils are wound to a length of 3" with No. 18 tinned wire. The turns are as follows: 22 turns for 40 meters; 12 turns, for 20 meter; and 5 turns for 10 meters.

The 806 plate coils are of the same construction as the 804 plate coils, however, they are wound to a length of 5" and have a diameter of 2 1/2". The 40 meter coil has 26 turns; 20 meter coil has 12 turns. The 10 meter coil has 4 turns of the same diameter but is only spaced to a length of 4".

The self-supporting coils are constructed with No. 12 tinned copper wire of the soft-drawn variety. The supporting strips are made of 1/16" celluloid strips 1/4" wide.

(Continued on page 250)

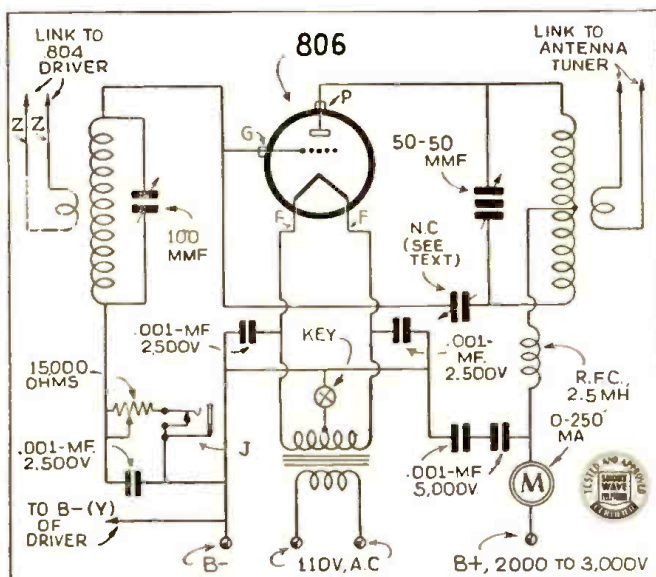

The 400 watt final amplifier, using the 806. The neutralizing condenser is a disc type, high-voltage neutralizing condenser. See photos for details.



# A Simple, Rotary 5-Meter Beam Antenna

By Arthur H. Lynch, W2DKJ

● IN the article we intended to write for this month's installment on the "5-40-400 Transmitter" we were going to cover the modulation and power equipment. However, we believe that the following information will be very much more timely and we will hold over the description of the power equipment until another time.

Perhaps last night was a particularly good night on five meters or, perhaps, it was just one of the regular nights that happen at this time of the year. In any event, we had our first opportunity to try out our new rotary beam antenna and the results were most gratifying.

From our Garden City, Long Island location, we worked one station in Worcester, Massachusetts; one in Scituate, Rhode Island; one in Wilton, Connecticut; one in Collingswood, New Jersey, and another in Abbingdon, Pennsylvania, which is about twenty-five miles southeast of Philadelphia. Satisfactory reports were received from all of these stations.

The accompanying drawings show the simple mechanical construction followed in building the rotary, 5-meter beam antenna, which was tried out with excellent results by the author. The cost of building the antenna is nominal and its directive effect will prove useful to every "Ham."

## A Beam That "Beams"!

During the time that the contacts to the northeast and to the northwest were made, our beam was in the correct position for stations located in those two directions. As an indication of the effective manner in which the beam was functioning, we worked a station in North Pelham, New York, which was at right angles to the beam and our report there was Q5-R-4. Ordinarily, the report from the same station would be R-9.

Rotating the beam produced a very noticeable effect on incoming signals and stations which were just about audible or not even audible on an ordinary type of antenna, could be brought in from an R-6 to an R-7 on the beam. Other stations a reasonable distance away, such as forty or fifty miles, were tuned in to their peak and then their intensity was observed as the beam was swung into and away from their direction. The signal level was found to vary from inaudibility, when the beam was at right angles to the station, to an R-7 or 8, when the beam was in the proper direction.

We have attempted to use any number of different types of arrays but our enthusiasm for the present unit comes, not only from the excellent fashion in which it performs but also from its simplicity of design and ease of construction.

Fortunately our location is such that a bi-directional beam will give us coverage in nearly every direction in

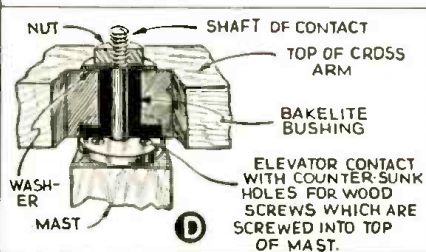
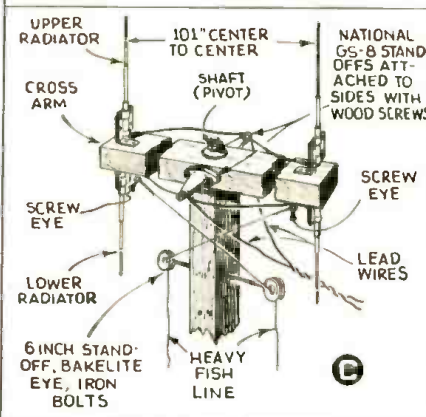
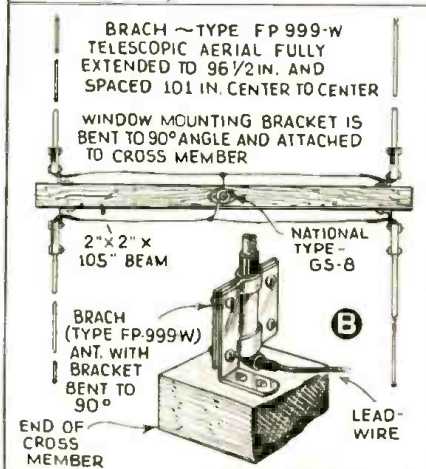
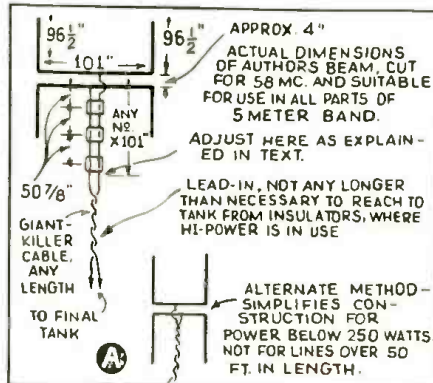

This Beam Antenna, Including The Four Radiators And The Matching Sections—Also The Transmission Line, Was Constructed And Put In Operation In A Single Afternoon.

which we desire to transmit or receive if it can be made to rotate forty-five degrees. The arrangement that we have made for rotating our own beam is extremely simple, as will be observed from some of the accompanying sketches, and where ninety degrees or more of rotation is required, so that the beam will function in every conceivable direction, the construction should not be a particularly difficult mechanical task.

## Details of Our Beam Antenna

Somewhat more than fifteen years ago we secured a piece of well seasoned lumber three inches square and twenty feet long. The edges were trimmed off and the top was tapered so that it would not appear too unsightly and then the stick was given several coats of paint. It has been fastened to one of the studs on the side wall of the house in a corner beside the chimney, by four rather large lag bolts. It is doubtful that there is any kind of antenna which it has not supported during its rather long life but it has had more different types of aeriels perched on top of it in the past year than during all the rest of its life combined.

In order to provide ourselves with a beam which would make up, to a degree, for the low altitude of our home town as well as the low altitude of aeriels that we are permitted to erect under the restrictions imposed by the village board, we wanted something that would provide reasonable efficiency but would not produce an appearance of a Christmas tree perched on our roof top.

When the L. S. Brach Manufacturing Corporation introduced Telescopic Fishpole antennas, designed for mounting on automobile bumpers and apartment house windows we got the notion that they could be used very satisfactorily in connection with the building of multi-element ultra hi-frequency antenna systems. It is hard to imagine a more useful arrangement than our present beam and, when it is considered that it was built and set up on top of our mast in a single afternoon the value of this type of radiator, to the ultra high-frequencies, becomes obvious.

## Aerial Withstands Wind In Good Shape

These aeriels are made of spring steel. They taper, so that they have extremely low wind resistance and the radiators themselves can hardly be seen a block (Continued on page 266)



# Short Wave Scouts

## FORTY-FIRST TROPHY

Presented to  
SHORT WAVE SCOUT  
**ALFRED K. KULECK**  
57 E. Parker St.  
Scranton, Pa.

103 Stations—91 Foreign

For his contribution toward the advancement of the art of Radio

by



Magazine

● THE forty-first Short Wave Scout Trophy goes to Alfred K. Kuleck of Scranton, Pa., for his excellent total of 103 verification cards, 91 of which were foreign. These stations were received on a 1936 Philco model 660X receiver employing 10 tubes with a 50 ft. single wire some 30 ft. high. Mr. Kuleck's list represents a very interesting period of DXing and he is to be congratulated for his untiring efforts.

His list was neatly prepared, and the cards were in the same chronological order as the list, which greatly aids checking by the judges—other contestants please note!

The complete list of the stations and verifications submitted follows:

### Stations Heard by Mr. Kuleck

Call—Frequency	Location
<b>United States</b>	
W1XAL—15.120 mc.	University Club, Boston, Mass.
W1XAL—11.790 mc.	University Club, Boston, Mass.
W1XAL—6.040 mc.	University Club, Boston, Mass.
W2XAD—15.330 mc.	General Electric Co., Schenectady, N.Y.
W2XAF—9.530 mc.	General Electric Co., Schenectady, N.Y.
W3XAL—17.780 mc.	Bound Brook, N.J.
W3XAL—6.100 mc.	Bound Brook, N.J.
W3XAU—9.590 mc.	Philadelphia, Pa.
W3XAU—6.060 mc.	Philadelphia, Pa.
W9XAA—11.830 mc.	Chicago, Ill.
W9XAA—6.080 mc.	Chicago, Ill.
W9XF—6.100 mc.	Chicago, Ill.
<b>Canada</b>	
CFCX—6.005 mc.	Canadian Marconi Co., Montreal, Canada.
CJRO—6.150 mc.	Winnipeg, Manitoba, Canada
CJRX—11.720 mc.	Winnipeg, Manitoba, Canada.
<b>Cuba</b>	
COCD—6.130 mc.	Havana, Cuba
COCH—9.128 mc.	General Broadcasting Co., 2 B St., Vedado, Havana
COCO—6.010 mc.	P.O. Box 98, Havana, Cuba. Daily
COCQ—9.750 mc.	De la "RCA Victor" Calle 25 No. 445, entre 6y 8 Vedado, Havana
COCX—11.435 mc.	La Voz del Radio "Philco," Apartado 32, Havana, Cuba
<b>Mexico</b>	
XEFT—9.510 mc.	Av. Independencia 28 Vera Cruz, Mex.
XEXA—6.132 mc.	Departamento Autonomo De Publicidad y Propaganda, Mexico City, Mexico.
XEUZ—6.120 mc.	Nat'l Broadcasting Network-Cadena Radio Nacional, 5 de Mayo 19 y 21, Mexico, D.F.
<b>West Indies</b>	
HIN—6.243 mc.	La Voz del Partido Dominicano. Ciudad Trujillo, Dom. Rep.
HIT—6.630 mc.	"La Voz de La RCA Victor" Apartado 1105 Ciudad Trujillo, Dominican Republic.



● ON this page is illustrated the handsome trophy which was designed by one of New York's leading silversmiths. It is made of metal throughout, except the base, which is made of handsome black Bakelite. The metal itself is quadruple silver-plated, in the usual manner of all trophies today.

It is a most imposing piece of work, and stands from tip to base 22½". The diameter of the base is 7¾". The diameter of the globe is 5¼". The work throughout is first-class, and no money has been spared in its execution. It will enhance any home, and will be admired by everyone who sees it.

The trophy will be awarded every month, and the winner will be announced in the following issue of SHORT WAVE & TELEVISION. The winner's name will be hand engraved on the trophy.

The purpose of this contest is to advance the art of radio by "logging" as many short-wave phone stations, amateurs excluded, in a period not exceeding 30 days, as possible by any one contestant. The trophy will be awarded to that SHORT WAVE SCOUT who has logged the greatest number of short-wave stations during any 30-day period.

## HONORABLE MENTION

W. A. Dennis  
E. Berlin, Conn.  
J. Dolzanski  
Winnipeg, Man. Canada  
Dr. G. D. DiMarco  
Chicago, Ill.  
William Elliott  
New York City, N.Y.  
Theodore Bottema  
Bethlehem, Pa.

HIX—6.340 mc.—Secretaria De E de Comunicaciones y Obras Publicas., Ciudad Trujillo, Dom. Rep.  
H11J—5.865 mc.—Box 204, San Pedro de Macoris, Dom. Rep.  
H13C—6.730 mc.—"La Voz de La Feria"—La Romana, Dom. Rep.  
H13U—6.015 mc.—"La Voz del Comercio"—Santiago, Dom. Rep.  
H18A—6.479 mc.—"La Fa-Doce en el Aire"—Apartado 1912, Ciudad Trujillo, Dom. Rep.  
H12S—5.915 mc.—P.O. Box A103, Port au Prince, Haiti.  
"Radio-Fort-De-France"—9.450 mc.—Edouard Boullanger Fils, Fort de France, Martinique, French West Indies.

### Central America

T14NRH—9.670 mc.—"La Voz de Costa Rica," Amando Cespedes Marin, Apartado 40, Heredia, Costa Rica.  
TGW—9.450 mc.—Radiodifusora Nacional, Ministro de Fomento, Guatemala City, Guatemala  
HRD—6.235 mc.—"La Voz de Atlantida," La Ceiba, Honduras  
HP5B—6.030 mc.—Mira Mar, Apartado 910, Panama City, Panama  
HP5J—9.590 mc.—La Voz de Panama, Apartado 867, Panama City, Rep. of Panama

### South America

LRX—9.660 mc.—Radio El Mundo, Buenos Aires  
LRU—15.280 mc.—Radio El Mundo, Buenos Aires  
PRP5—9.501 mc.—Comp. Radio Internacional Do Brazil, P.O. Box 709, Rio de Janeiro, Brazil  
VP3MR—6.010 mc.—The Br. Guiana Broadcasting Co. Ltd., The Voice of Guiana, Georgetown, British Guiana  
CB615—12.300 mc.—Radio Service, Bandera 176, Casilla 761, Santiago, Chile  
HJ1ABE—9.500 mc.—"La Voz de Los Laboratorios Fuentes"  
HJ1ABG—6.042 mc.—Emisora Atlantico, Barranquilla, Colombia  
HJ1ABP—9.600 mc.—Radio Cartagena, Apartado 37, Cartagena, Colombia  
HJ3ARD—6.050 mc.—Emisora Nueva Granada, Colombia Broadcasting S.A., Apartado 509, Bogota, Colombia  
HJ3ABX—6.122 mc.—"La Voz de Colombia, Apartado No. 26-65, Bogota, Colombia.  
HJ4ABE—6.097 mc.—"Lo Voz de Antioquia", Medellin, Colombia.  
HJ4ABP—6.030 mc.—Emisora Philco, Medellin, Colombia  
HSJB—4.107 mc.—La Voz de Los Andes, Quito, Ecuador.  
HC2JSB—7.854 mc.—"Ecuador Radio," Guayaquil, Ecuador  
HC2RL—6.635 mc.—P.O. Box 759, Guayaquil, Ecuador.  
PRADO—6.625 mc.—Fabrica de Tejodos de "El Prado," Apartado 98, Riobanica, Ecuador.  
OAX1A—6.125 mc.—Companio de Radios "Delcar", Casilla No. 9, Chiclayo, Peru.  
YV1RB—5.800 mc.—Ecos Del Zulia, Apartado Correos No. 37, Maracaibo, Venezuela.  
YV3RC—6.158 mc.—Now YV5RD, Radiodifusora Venezuela, Caracas, Venezuela.  
YV5RC—5.800 mc.—"Le Habla a la Nacion" Radio Caracas, Caracas, Venezuela.  
YV5RP—6.270 mc.—"La Voz de La Philco", Apartado 508, Caracas.  
YV6RV—6.520 mc.—Now YV4RB, Radiodifusora "La Voz de Carabobo", Valencia, Venezuela.  
YV9RC—6.400 mc.—Now YV5RH, Emisora Ondas Populares, Apartado 1931, Caracas, Venezuela.





### Europe

OER2—11.801 mc.—Osterr. Radioverkehrs A.G., Wien, 1, Johannesgasse 4 b, Vienna, Austria.

(Continued on page 271)

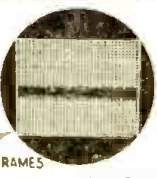
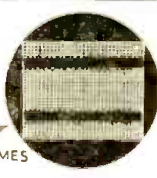
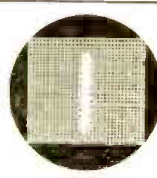
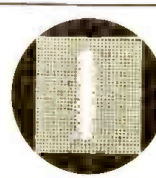
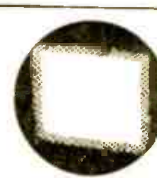
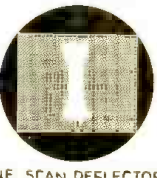
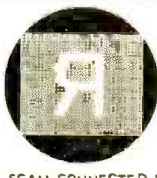
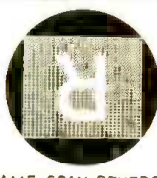

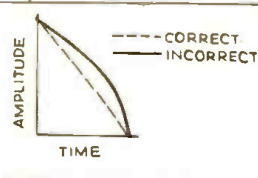
# When That Television Image Goes Blooey!

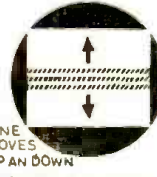
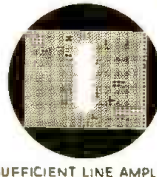
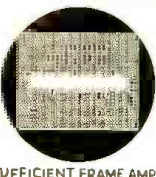
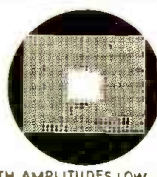
 <p>50 FRAMES</p>	 <p>25 FRAMES</p>			
<p>HUM ON GRID OF CATHODE-RAY TUBE. FAULTY SMOOTHING OR DECOUPLING OR PICKUP IN LEADS</p>		<p>LINE SCAN DISCONNECTED. FAULTY TUBES OR DISCONNECTION IN SCAN UNIT.</p>	<p>FRAME SCAN DISCONNECTED. FAULTY TUBES OR DISCONNECTION IN SCAN UNIT.</p>	<p>HUM ON DEFLECTOR COILS. FAULTY SMOOTHING</p>
				
<p>LINE SCAN DEFLECTOR COILS IN OPPOSITION. REVERSE ONE COIL.</p>	<p>LINE SCAN CONNECTED LEFT FOR RIGHT. REVERSE LEADS OF DEFLECTOR COILS.</p>	<p>FRAME SCAN REVERSED. REVERSE LEADS</p>	<p>BEAM TOO FAST</p> <p>BEAM TOO SLOW</p>	<p>NON-LINEAR PULSE IN FRAME SCAN. PROBABLY SAW-TOOTH GENERATOR PULSE</p>
				
<p>FAST</p> <p>SLOW</p> <p>NON-LINEAR PULSE IN LINE SCAN. FAULTY TUBE IN LINE SCAN UNIT</p>	<p>AMPLITUDE</p> <p>TIME</p> <p>--- CORRECT</p> <p>— INCORRECT</p>	<p>LINE MOVES UP AND DOWN</p> <p>NO FRAME HOLD. FAULT IN FRAME SCAN SYNCHRONIZING UNIT.</p>	<p>INSUFFICIENT LINE AMPLITUDE. FAULTY TUBE OR LOW PLATE VOLTAGE TO LINE SCAN UNIT</p>	<p>INSUFFICIENT FRAME AMPLITUDE. FAULTY TUBE OR LOW PLATE VOLTAGE TO FRAME SCAN UNIT.</p>
				
				<p>BOTH AMPLITUDES LOW. LOW PLATE VOLTAGE TO SCAN UNITS. FAULTY RECTIFIER TUBE.</p>

Television receivers, whether of the scanning disc or cathode ray type, have a number of peculiar ailments, prominent among which we find reversed images, peculiar shadow effects, fuzzy images, etc. The accompanying picture, reproduced by the courtesy of Television and Short-

Wave World (London), shows what frequently happens to the image on cathode ray television receivers, and the indicated remedies in each case. It won't be long now before television enthusiasts and experimenters in this country will be studying these peculiarities in television

image pick-up on cathode ray receivers, so you had better cut this out and paste it in your scrap-book for reference. The above analysis chart should not be interpreted too literally as in some instances, the same effects might be produced due to some other defect or improper adjustment in the apparatus.

## Piping R. F. With Concentric Lines

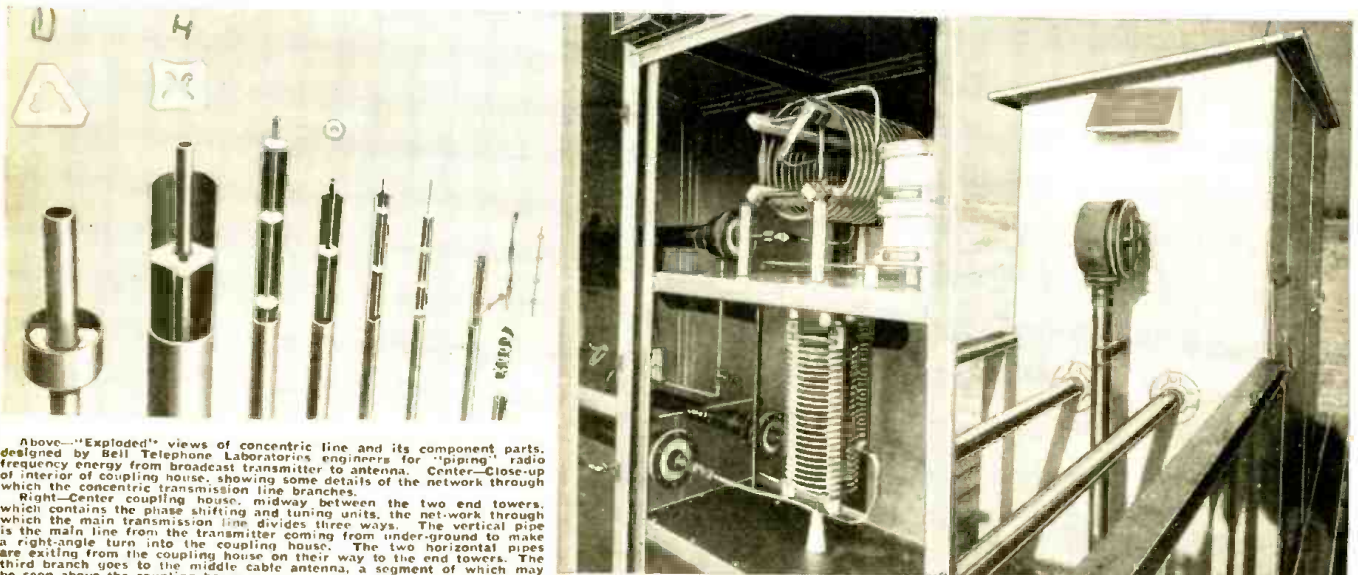

Above—"Exploded" views of concentric line and its component parts, designed by Bell Telephone Laboratories engineers for "piping" radio frequency energy from broadcast transmitter to antenna. Center—Close-up of interior of coupling house, showing some details of the network through which the concentric transmission line branches. Right—Center coupling house, midway between the two end towers, which contains the phase shifting and tuning units, the network through which the main transmission line divides three ways. The vertical pipe is the main line from the transmitter coming from under-ground to make a right-angle turn into the coupling house. The two horizontal pipes are exiting from the coupling house on their way to the end towers. The third branch goes to the middle cable antenna, a segment of which may be seen above the coupling house.

Photos from Western Electric Company.

● RADIO frequency transmission lines in the more general sense include all conductors of radio frequency currents from the shortest interconnection between radio circuit elements to the longest carrier frequency telephone line. In the broadcast field interconnections between circuit elements are invariably very short electrically so that considerations of their electrical behavior from the standpoint of transmission line theory is generally un-

By P. H. Smith

Member, Technical Staff, Bell Telephone Laboratories

essary. However, at higher frequencies, due to their greater electrical length, short connections often exhibit marked transmission line characteristics which may at times become detrimental to the successful operation of a circuit. A consideration of the behavior

of these connections as radio frequency transmission lines will often indicate the trouble and may even suggest ways of taking advantage of some of their desirable characteristics.

In the usual sense, the radio frequency transmission line comprises the connection between the antenna and radio equipment. At broadcasting stations the many advantages afforded by locating the antenna a few hundred feet away from (Continued on page 267)



# High Efficiency Doubling

—R. J. Hagerty, W6JMI

● PROBABLY the two greatest handicaps of amateur transmitters are lack of adequate excitation and low-efficiency frequency multiplication. It is disconcerting, to say the least, to have or design a transmitter for certain bands only to find out that at higher frequencies there just isn't enough excitation to the final stage. This is due to the fact, in most cases, that the doubler stages will not put out sufficient

RF (radio frequency) and unfortunately the higher in frequency we go the more our excitation falls off. And, on the other hand, it seems a waste of time and money to have a long string of doublers whose output is just about the same as the output of the crystal oscillator stage itself.

The answer and solution to the above is high-efficiency frequency multiplication or push-push doubling. Just why

can be briefly explained by the following: In its ordinary form a doubler consists of a single tube whose plate circuit is tuned to twice that of the input or grid circuit. The only reason it works is because there is distortion present in every radio tube and we capitalize on this by juggling the grid bias, excitation, introducing regeneration, raising the plate voltage, etc., until we cause the (Continued on page 269)

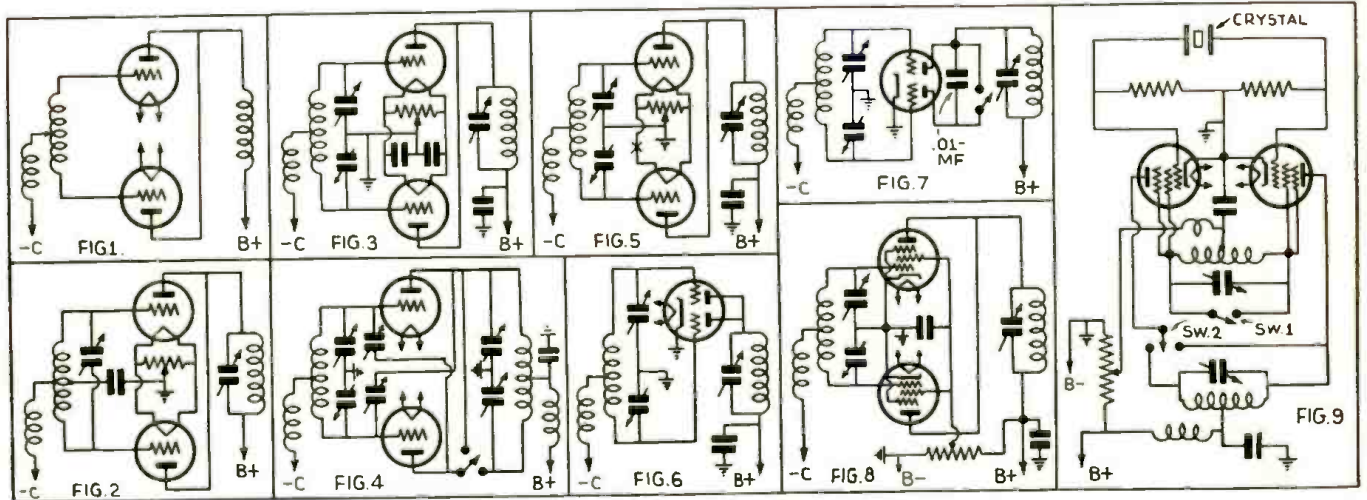

A variety of "push-push" R.F. doubler circuits are displayed above. The average "Ham" will find a study of these circuit well worth while.

## A "Folded Doublet" Saves Space

● IT is a well-known fact that if properly constructed and mounted, the doublet antenna will greatly reduce general background noise and "hash" caused by various electrical apparatus in the immediate vicinity of the receiver.

In the drawings we find that two Englishmen G2IS and G6DT have constructed a folded doublet. The reason for the peculiar shape of the antenna was the lack of available mounting space for the usual doublet. We can not vouch for the technical assets of

this antenna. However, the claims of the designers of this folded doublet are substantial arguments in its favor.

The four drawings show the various mechanical details and its construction is very simple. Of course, the usual rules applying to doublet antennas apply to this one. The antenna proper, or the folded section, should be located outside the field of the noise, and the signal from the antenna thus conducted through the field with a twisted feed-line. If, for any reason, it is impossible

to locate the antenna outside of the range of the noise its benefits will be very few in number.

Coupling between the receiver and the feed-line consists of the usual coil. The coupling between the two coils, that is the coil at the receiving end of the feed-line, and the tuned input coil of the receiver should be variable; if one wants to go to the trouble, a further precaution against noise can be brought about by the use of a Faraday shield placed between the two (Continued on page 248)

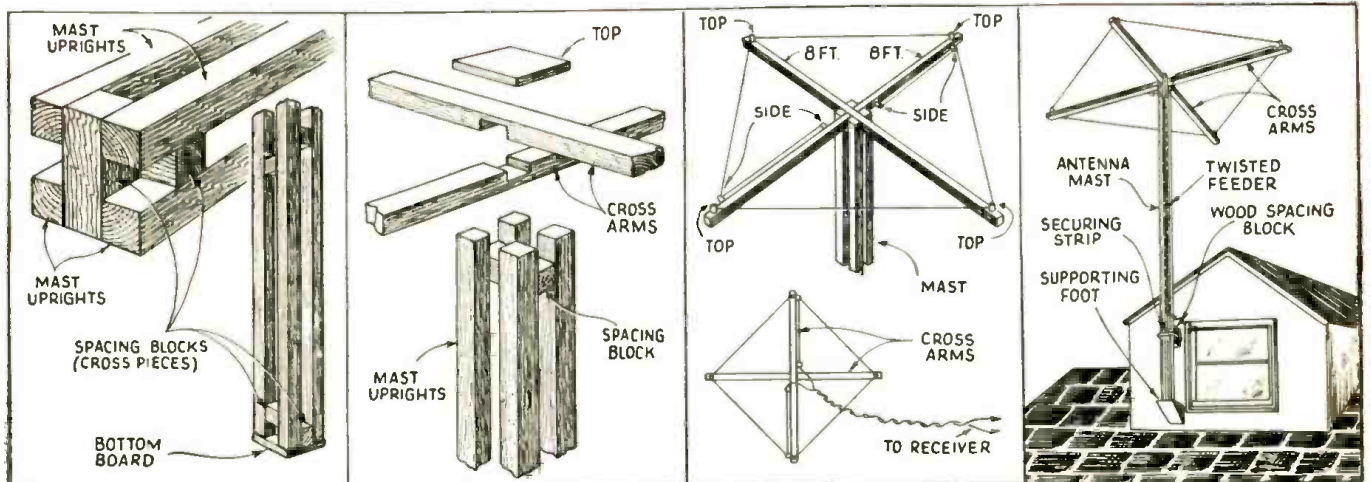

Dimensions of the wood framework and supporting mast for a "folded doublet" antenna for short-wave receiving purposes are given in the above drawing. Very good results are claimed for it.



# WHAT'S NEW

# In Short-Wave Apparatus

The short-wave apparatus here shown has been carefully selected for description by the editors after a rigid investigation of its merits.

## New 1938 Super Skyrider



Front view of the new 1938 Super Skyrider, an excellent "communications" type receiver for "Ham" and "Fan." A high degree of selectivity is afforded, thanks to a carefully designed I.F. amplifier featuring variable selectivity, plus a crystal filter circuit. No. 611.

One of the latest Communications type receivers, suitable for all "Ham" and "Fan" requirements. This receiver provides excellent band-spread and has a variable selectivity feature. Six bands are covered by means of a switch, including the broadcast band; the complete range is 62,000 to 545 kc. The set has a calibrated dial, an "S" meter, crystal filter and beat oscillator.

● MANY new and interesting features are combined in the 1938 Super Skyrider, one of them is the unique construction of the tuning controls. These are equipped with heavy balance wheels which makes tuning far easier. By merely giving a twist to the knobs it will continue to rotate for quite some time. Further—the tuning controls are accurately calibrated. As can be seen from the photograph, the main dial is clearly marked with each band and calibrated in frequency. The band-spread control has a special combination of electro and mechanical features providing over 1,000 degrees of band-spread, which is quite ample for comfortable tuning.

This receiver incorporates a frequency range of 62,000 to 545 kc. Six bands covering everything of "air" interest—5 meters, 7 meters (2-way police), all "broadcast" frequencies, foreign short-wave, aircraft, relay broadcasting, etc. Band 1—frequency 545 kc. to 1,550 kc.; Band 2—1,550 kc. to 4.3 mc.; Band 3—4.2 mc. to 10.2 mc.; Band 4—9.8 mc. to 20.5 mc.; Band 5—19 mc. to 36 mc.; Band 6—35 mc. to 62 mc. A Band Pointer

is used as a tuning aid, found only on the Super Skyrider. The average over-all sensitivity of the receiver is better than 1 microvolt.

Now for selectivity. There is a wide range of variable selectivity, from "single-signal" razor-edge sharpness to broad high-fidelity. New and improved iron core I.F. transformer circuits permit this "Wide Range Selectivity" control (7.5 kc. to 25.5 kc.). With crystal in, selectivity is better than one kc., giving a total ratio of variable selectivity of over 30 to 1.

Band Spread: The Super Skyrider not only satisfies the usual band-spread requirements but betters them. Band-spread is accomplished in a unique electro-mechanical manner, highly efficient electrically; simple and smooth mechanically. A special high frequency condenser with double rotors and single stator units, makes a tuning-unit with the band-spread section forming an integral part of the main condenser. This simple and sensible design feature, by eliminating extra wiring and parallel insulator losses in the tuned circuits, achieves worthwhile improvements, particularly at the higher frequencies. The added mechanical rigidity gained by such a system makes for steadier signals and smoother tuning ability. The new dynamic balanced tuning and the large controls represents a new and exclusive concept in band-spread technique. Over 1,000 degrees of band-spread calibration provide better than 5 kc. per division on the 20 meter band, and 25 kc. per complete turn of the knob.

Other outstanding features—11 (Continued on page 268)

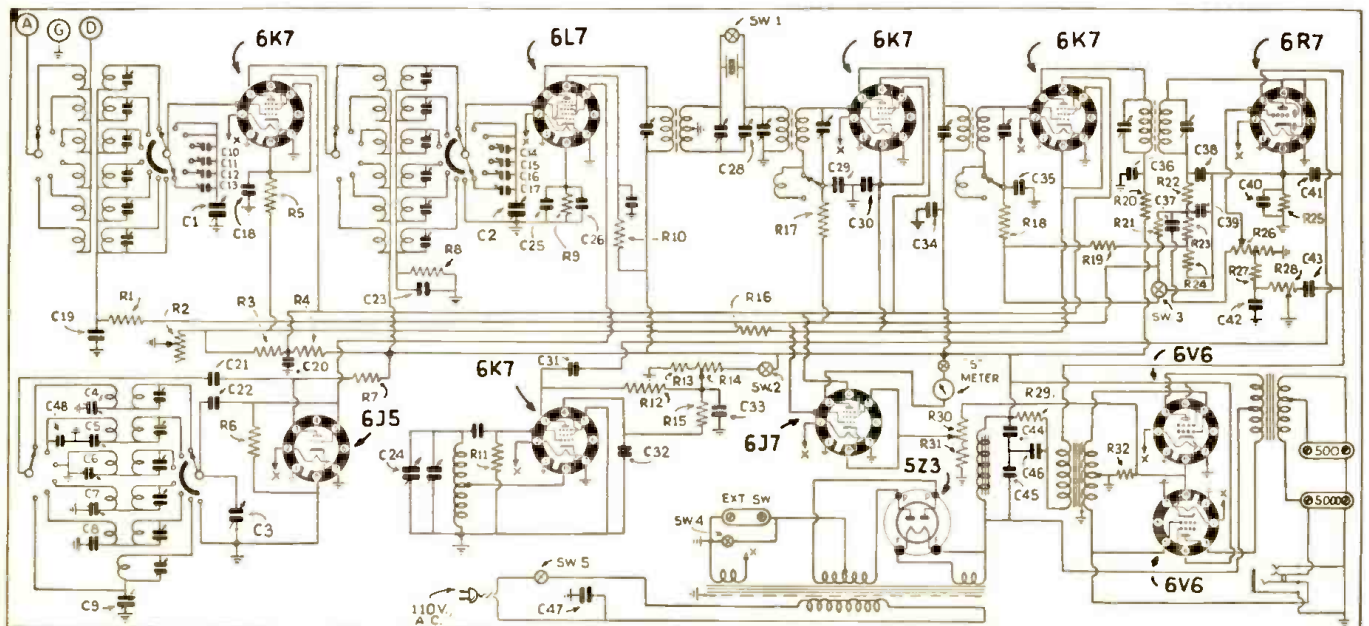

Circuit diagram of the 1938 Super Skyrider, with crystal filter.

Names and addresses of manufacturers of apparatus furnished upon receipt of postcard request; mention No. of article.



# New "Overseas" Dial Makes S-W Tuning Easy

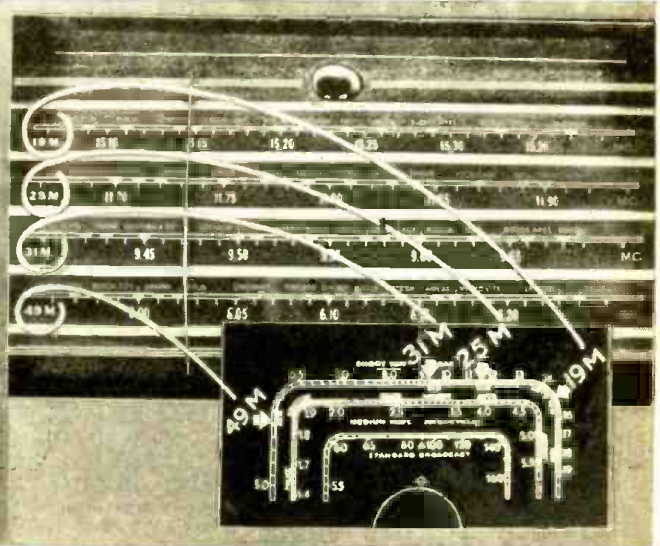
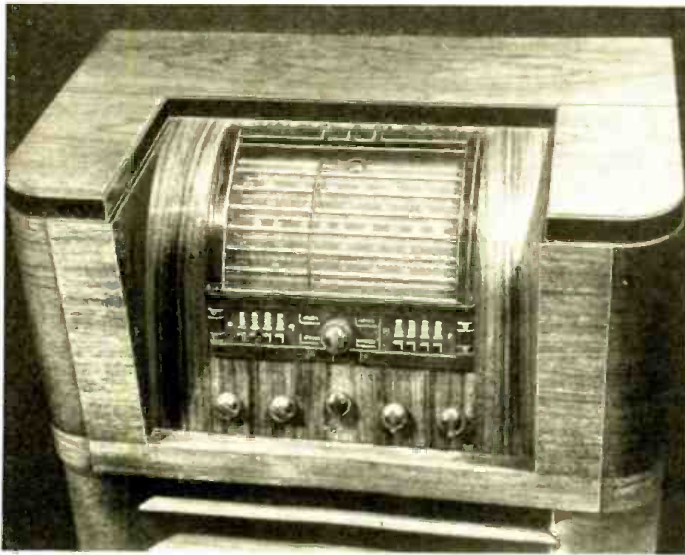

A remarkable new circuit development by RCA Victor engineers has made it possible to spread out the closely spaced foreign radio stations so that they occupy fifty times more space on the dial and actually make foreign tuning as easy as tuning domestic stations. Electric tuning is another important advance. Press a button and your station is automatically and precisely tuned in. Photo at right, above, shows comparison of new band-spread tuning on "Overseas" dial with the crowded S-W tuning on ordinary dial.

● PERHAPS the most spectacular feature in the new RCA Victor receivers is push-button electric tuning and arm-chair control. Simply push a button—and there's your station—it's as easy as that. There are eight of these buttons. Each of them can be pre-set to different radio stations and these stations precisely tuned in by merely pressing the button. It's so foolproof that a child or a careless servant cannot hurt the mechanism by tinkering with the push buttons or dials. A remarkable new engineering development called *automatic frequency control* is responsible for the new electric tuning feature. Reduced to its simplest terms, this means that in automatic operation the radio circuit will actually adjust itself to compensate for any variation in the mechanical system so that the station is precisely tuned to its most resonant point. Once adjusted to the stations you want you can always get them back, precisely tuned, every time thereafter by merely pressing the button.

This same remarkable push-button system for electric tuning is available in the form of an inconspicuous control tablet which may be placed on the arm of an easy chair or an end-table and connected to the radio set in any part of the room

by a flat cable that may be concealed under the carpet or along the wall baseboard.

The new *overseas* dial makes the tuning of short-wave stations actually as simple as tuning your favorite domestic program. The four most important short-wave bands have been spread out in a straight line across the front of the radio set. For instance, the popular 25-meter band, which formerly occupied a space on ordinary dials never more than 1/2 inch in length, has been spread out to 9 1/2 inches, and the important foreign stations are marked by name on the dial. This means that you will be able to get the various foreign stations positively and easily every time you want them, without endless searching and delicate adjustment, or crowding from the many nearby foreign stations. The same arrangement holds true for the 49-, 31- and 19-meter bands.

Good clean-cut reception on both short-wave and local stations is assured in the new models by the use of special air trimmers and magnetite core transformers which are impervious to temperature and humidity changes and keep the radio circuits permanently aligned as they were intended, so that stations are always found in exactly the same place on the dial.

Another development, magic voice tone

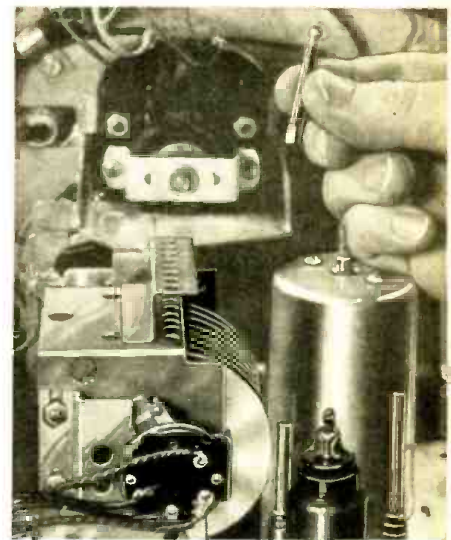

Above—rear view of tuning mechanism, showing one of the pins that is inserted in holed plate atop condenser to "set" device for a certain station.

No. 644

quality, which attracted a great deal of attention last year, has this year been brought to an ever higher state of perfection. The space immediately surrounding (Continued on page 270)

## Fixed Mica Padding Condensers



● Adjustable mica padding condensers, replacing the usual fixed condensers with trimmer in parallel, are shown in photo. These units are intended for use in intermediate-frequency and radio-frequency circuits.

Each unit is held together by a central screw by means of which the capacity may be adjusted. Amateurs can readily vary the capacity over a wide range by adjusting the trimmer screw, thereby resonating circuits without addition of a trimmer condenser.

Dual units with one terminal as common, are available in plus or minus 10% tolerances, up to .01 mf. for the combination. Units are fabricated of finest grade mica and impregnated to repel moisture. Loss factor is reduced to negligible value, making the condenser highly efficient at all frequencies. Stray capacity is almost entirely eliminated, when using this single

unit instead of the two condensers previously required, since capacity is now concentrated in a single unit. No. 645

This article has been prepared from data supplied by courtesy of Aerovox Corp.

## New 1.5 Volt Tubes Work on Dry Cell

● TWO interesting new battery type tubes have just been announced by Raytheon. One is a *single triode*, while the other is a *twin triode*. Both of these tubes operate directly from a 1.5 volt dry cell. They should greatly facilitate the construction of portable apparatus because of their filament rating. The usual rheostat and two dry cells required for the ordinary tube employing a 2-volt filament can now be replaced with a single dry cell.

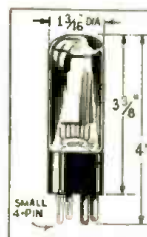

No. 646

Complete technical data on both tubes is given in the following table.

RK-42

### Triode Amplifier (Filament Type)

Bulb—T-9 Base—Standard 4-Pin

#### DIMENSIONS

Maximum Overall Length—4"

Maximum Diameter—1 1/8"

#### BASING—R.M.A. Numbering

Pin 1—Filament +

Pin 2—Plate

Pin 3—Grid

Pin 4—Filament —

#### RATINGS

Filament Voltage—1.5 volts

Filament Current—0.06 amp.

Maximum Plate Voltage—180 volts

#### DIRECT INTERELECTRODE CAPACITANCES

Grid to Plate—6 uuf.

Input—3 uuf.

Output—2.1 uuf.

#### AMPLIFIER—CLASS A

Plate Voltage—180 volts

Grid Bias—-13.5 volts

Amplification Factor—8.2

Plate Resistance—10300 ohms

Transconductance—800 umhos.

Plate Current—3.9 ma.

(Continued on page 256)

Names and addresses of manufacturers of apparatus furnished upon receipt of postcard request; mention No. of article.



# Let's "Listen In" With

*Joe Miller*

**Our Short Wave  
"DX" Editor**

Winner of 30th "S-W Scout" Trophy

All Times E. S. T.

● DX for the past month (June) has been quite active and numbers of new catches have been heard by those DXers who haven't packed away the old DX rig in mothballs for the summer.

We have spent much time (and currency) in rigging up a new matched-impedance *doublet antenna* here and the results certainly atoned for the bruises, blisters, mosquito bumps, etc., suffered in erecting the antenna in this neck of the woods.

Stations in Europe and Asia, to which antenna is partial, being directional East and West, came in with "roaring" signals, and we await the quiet DX season this fall and winter with eagerness, confident in the belief this sky-wire will "drag 'em in" as never before, especially from the Orient.

Details on the doublet will be sent to all DXers who will send a stamped self-addressed envelope. And so to DX:

**SIAM**

HSE2, 19.016 mc., at Bangkok, has been heard late in June, twice in one morning, at 6:30 a.m., and again at 9:10 a.m., both times in communication with DFB, Nauen, Germany, on 17.52 mc. HSE2 had a stronger signal at the earlier time but was well heard at both times.

As our friend Sangiem Powtongsook, Asst. Engineer at HS8PJ has told us, Siamese radiophone stations are now equipped with apparatus for inverted speech modulation, and we noted that in our reception of HSE2, DFB was clearly heard to call "Hello, Bangkok," several times and to address Mr. Powtongsook in person, before both switched to inverted speech.

In an unusually long letter, Mr. Powtongsook, a young man of 27, operator of 3 Siamese amateur stations, and who has amassed all his radio knowledge from the study of books purchased from the U. S. A. and England, gives us some valuable data concerning the operation of the famous Siamese Xmitrs.

Here's the dope: HSE2, 19.016 mc., fones JVE, Tokio, 15.66 mc. anytime between 11 p.m. and 6 a.m., and HSE2 also fones DFB anytime between 3-5 a.m. and 8-9 p.m., when there is a commercial call.

HSP, on 17.74098 mc., or, in fact, 17.741 mc. (this differs from frequency given in HSP veri), will be used only where HSE2 is unavailable. Ordinarily, HSP will be heard on CW only.

During the period from August-November, 1936, HSG2, 15.53 mc., was used for radiophony. However, upon Mr. Powtongsook's suggestion, HSE2 was used and results using same power as HSG2 were much improved, so HSG2 was thereafter silent.

Regarding the recent rumor that Siam would no longer verify reports, it is clearly stated that all reports are welcomed, and will be answered as soon as possible, but owing to the lack of staff and time, some delay must be expected.

Thank you, Mr. Powtongsook, for a most informative and interesting letter, and



SVIKE—the Greek station sends a handsome QSL: light blue red letters.

please write again, often. OM!

hearing the Rangoon Gov't. station during April and May, and that the station shifted often, being on 6.08, 6.06, and lastly 6.005 mc. Tnx for the "bouquet," Jim, and glad to hear from you.

**MADAGASCAR**

Radio Tananarive, 6.01 mc., at Tananarive, has at last replied to our report of last November, and, to our joy, verifies most specifically our report of November 29, when we heard them with such an unusual signal that we were somewhat doubtful that we were actually hearing Madagascar! Reception that morning was exceptionally good, especially from the direction of South Africa, as ZEB in Southern Rhodesia was also heard, though not well enough to get an acceptable report.

Radio Tananarive is lately reported to be using frequencies in the 25 and 31 meter bands, near 9.50 and 11.81 mc., besides their 6.01 mc. wave. Times reported are 12-12:30 a.m. and 9:45-10:30 a.m. We have not been informed as to which frequencies may be heard at these times, and doubt that all broadcast simultaneously.

QRA is: Le Directeur des P.T. Administration des P. T. T., Tananarive, Madagascar.

**MOZAMBIQUE**

CR7BH, 11.718 mc., Laurence Marques has verified reports of Ashley Walcott, John DeMyer, Charles Miller and Irving Cohen. Card is green and black, in same design as CR7AA's QSL. The best time for reception here is between 9:30-11 a.m. Full schedule is: Weekdays 11:45 p.m.-12:30 a.m.; 9:30-11 a.m.; 12:45-3:45 p.m. On Sundays 5:30-7 a.m.; 10 a.m.-12:30 p.m.; 1:30-3:30 p.m. (Continued on page 236)

**FRENCH SOMALILAND**

FZE8, 17.28 mc., located at DJIBOUTI, has confirmed our recent reception of their station while heard in contact with France; a *letter-veri* with the gorgeous stamps on cover for which the French Colonies are famous. Quite informally, the Chief Engineer comments on a photo sent with our report, adding that a pipe, shown in photo, must have helped overcome our discomfort in posing for the picture, hi!

The Chief also adds that FZE8 is generally to be heard in radio-phone communication with France on the first days of each month from 7:35-8:15 a.m. The veri took just 5 weeks to arrive, to and from DJIBOUTI! Unusually prompt!

FZE8 was again heard phoning France, this time at 9:05 a.m. Signal was an R7-8 here! QRA (address) in previous issue.

**INDIA**

VVS, 12.87 mc., Mingaladon, Burma, which is considered a separate country from India proper, was logged on several occasions during the past month, at 5:50 a.m. and again at 6 a.m. using inverted speech. A typical Asiatic "bumpy" signal here, with good strength. VVS generally phones VVN, 13.26 mc., at Fort Madras, India.

In a letter from Mr. Ashley at VWY, Poona, the QRA of VVS is given as: Station Engineer, Wireless Station VVS, Mingaladon, Burma, India, VVS, is located just to the HF side of CNR, so should not be too difficult to "log."

Jim Lanyon of Vancouver, B. C., relates

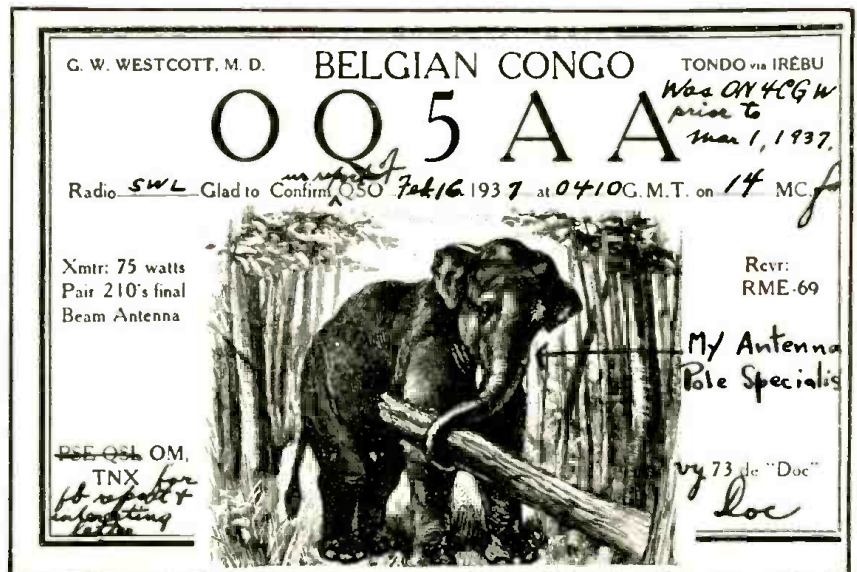

OQ5AA—From the Congo comes this fine card, all in black.





# World S-W Station List

## Complete List of Broadcast, and Telephone Stations

All the stations in this list use telephone transmission of some kind. Note: Station calls printed in bold face are broadcast stations; others are telephone stations.

Please write to us about any new stations or other important data that you learn through announcements over the air or correspondence with the stations.

↓ S.W. BROADCAST BAND ↓

Mc.	Call	
31.600	<b>W3XEY</b>	<b>BALTIMORE, MD.</b> , 9.494 m., Relays WFBR 4 pm-12m.
31.600	<b>W2XDV</b>	<b>NEW YORK CITY</b> , 9.491 m., Addr. Col. Broad. Systm, 485 Madison Ave. Daily 5-10 pm.; Sat. and Sun. 12.30-5, 6-9 pm.
31.600	<b>W4XCA</b>	<b>MEMPHIS, TENN.</b> , 9.494 m., Addr. Memphis Commercial Appeal. Relays WMC.
31.600	<b>W8XAI</b>	<b>ROCHESTER, N. Y.</b> , 9.494 m., Addr. Stromberg Carlson Co. Relays WHAM 7.30-12.05 am.
31.600	<b>W8XWJ</b>	<b>DETROIT, MICH.</b> , 9.494 m., Addr. Evening News Ass'n. Relays WWJ 6-12.30 am., Sun. 8 am-12 m.
31.600	<b>W9XPD</b>	<b>ST. LOUIS, MO.</b> , 9.494 m., Addr. Pulitzer Pub. Co. Relays KSD.
26.400	<b>W9XAZ</b>	<b>MILWAUKEE, WIS.</b> , 11.36 m., Addr. The Journal Co. Relays WTMJ from 1 pm.
26.100	<b>GSK</b>	<b>DAVENTRY, ENG.</b> , 11.49 m., Addr. B. B. C., London. Operates irregularly 5.45-8.55 am., 9.55 am.-12 n.
25.950	<b>W6XKG</b>	<b>LOS ANGELES, CAL.</b> , 11.56 m., Addr. B. S. McGlashan, Wash. Blvd. at Oak St. Relays KGFJ 24 hours daily.
21.550	<b>GST</b>	<b>DAVENTRY, ENG.</b> , 13.92 m., Addr. (See 26.100 mc.) Irregular at present.
21.540	<b>W8XK</b>	<b>PITTSBURGH, PA.</b> , 13.93 m., Addr. Grant Bldg. Relays KDKA 7-9 am.
21.530	<b>GSJ</b>	<b>DAVENTRY, ENG.</b> , 13.93 m., Addr. (See 26.100 mc.) 5.45-8.55 am., 9.15 am.-12n.
21.520	<b>W2XE</b>	<b>NEW YORK CITY</b> , 13.94 m., Addr. Col. Broad. Syst., 485 Madison Ave. Relays WABC 6.30-9 am.
21.470	<b>GSH</b>	<b>DAVENTRY, ENG.</b> , 13.97 m. (See 26.100 mc.), 5.45-8.55 am., 9.15 am.-12 n.

↑ S.W. BROADCAST BAND ↑

21.420	<b>WKK</b>	<b>LAWRENCEVILLE, N. J.</b> , 14.01 m., Addr. Amer. Tel. & Tel. Co. Calls S. Amer. 7 am-7 pm.
21.080	<b>PSA</b>	<b>RIO DE JANEIRO, BRAZ.</b> , 14.23 m., Calls WKK daytime.
21.060	<b>WKA</b>	<b>LAWRENCEVILLE, N. J.</b> , 14.25 m., Addr. (See 21.420 mc.) Calls England morning and afternoon.
21.020	<b>LSNG</b>	<b>BUENOS AIRES, ARG.</b> , 14.27 m., Addr. Cia. Internacional de Radio. Works N. Y. C. 7 am.-7 pm.
20.860	<b>EHY-EDM</b>	<b>MADRID, SPAIN</b> , 14.38 m., Addr. Cia. Tel. Nacional de Espana. Works S. Amer. mornings.
20.700	<b>LSY</b>	<b>BUENOS AIRES, ARG.</b> , 14.49 m., Addr. Transradio Internat. Tests irregularly
20.380	<b>GAA</b>	<b>RUGBY, ENG.</b> , 14.72 m. Calls Arg., Brazil mornings.
20.040	<b>OPL</b>	<b>LEOPOLDVILLE, BELGIAN CONGO</b> , 14.97 m. Works ORG mornings.
20.020	<b>DHO</b>	<b>NAUEN, GERMANY</b> , 14.99 m., Addr. Reichspostzentralamt. Works S. Am. mornings.
19.900	<b>LSG</b>	<b>BUENOS AIRES, ARG.</b> , 15.08 m., Addr. (See 20.700 mc.) Tests irregularly.
19.820	<b>WKN</b>	<b>LAWRENCEVILLE, N. J.</b> , 15.14 m., Addr. A. T. & T. Co. Calls England daytime.
19.680	<b>CEC</b>	<b>SANTIAGO, CHILE</b> , 15.24 m., Addr. Cia. Internacional de Radio. Calls Col. and Arg. daytime.
19.650	<b>LSN5</b>	<b>BUENOS AIRES, ARG.</b> , 15.27 m., Addr. (See 21.020 mc.) Calls Europe daytime

Mc.	Call	
19.620	<b>VQG4</b>	<b>NAIROBI, KENYA</b> , 15.28 m., Addr. Cable and Wireless, Ltd. Calls London 7.30-8 am.
19.600	<b>LSF</b>	<b>BUENOS AIRES, ARG.</b> , 15.31 m., Addr. (See 20.700 mc.) Tests irregularly.
19.480	<b>GAD</b>	<b>RUGBY, ENG.</b> , 15.4 m. Calls VQG4 7.30-8 am.
19.355	<b>FTM</b>	<b>ST. ASSISE, FRANCE</b> , 15.5 m. Calls S. America mornings.
19.345	<b>PMA</b>	<b>BANDOENG, JAVA</b> , 15.51 m. Works Holland 5.30-11 am.
19.260	<b>PPU</b>	<b>RIO DE JANEIRO, BRAZ.</b> , 15.58 m., Addr. Cia. Radiotel. Brasileira. Works France mornings.
19.220	<b>WKF</b>	<b>LAWRENCEVILLE, N. J.</b> , 15.6 m., Addr. A. T. & T. Co. Calls England daytime.
19.200	<b>ORG</b>	<b>RUYSSSELEDE, BELGIUM</b> , 15.62 m. Calls OPL mornings.
19.160	<b>GAP</b>	<b>RUGBY, ENG.</b> , 15.66 m. Calls Australia 1-8 am.
19.020	<b>HS8PJ</b>	<b>BANGKOK, SIAM</b> , 15.77 m. Mondays 8-10 am.
18.970	<b>GAQ</b>	<b>RUGBY, ENG.</b> , 15.81 m. Calls S. Africa mornings.
18.890	<b>ZSS</b>	<b>KLIPHEUVEL, S. AFRICA</b> , 15.88 m., Addr. Oversens Comm. of S. Africa, Ltd. Calls GAQ 9-10 am.
18.830	<b>PLE</b>	<b>BANDOENG, JAVA</b> , 15.93 m. Calls Holland early am.
18.680	<b>OCI</b>	<b>LIMA, PERU</b> , 16.06 m. Tests with Bogota, Col.
18.620	<b>GAU</b>	<b>RUGBY, ENG.</b> , 16.11 m. Calls N. Y. daytime.
18.480	<b>HBH</b>	<b>GENEVA, SWITZERLAND</b> , 16.23 m., Addr. Radio Nations. Tests irregularly.
18.345	<b>FZS</b>	<b>SAIGON, INDO-CHINA</b> , 16.35 m. Works Paris early morning.
18.340	<b>WLA</b>	<b>LAWRENCEVILLE, N. J.</b> , 16.36 m., Addr. A. T. & T. Co. Calls England daytime.
18.310	<b>GAS</b>	<b>RUGBY, ENG.</b> , 16.38 m. Calls N. Y. daytime.
18.299	<b>YVR</b>	<b>MARACAY, VENEZ.</b> , 16.39 m. Works Germany mornings.
18.250	<b>FTO</b>	<b>ST. ASSISE, FRANCE</b> , 16.43 m. Works S. America daytime.
18.200	<b>GAW</b>	<b>RUGBY, ENG.</b> , 16.48 m. Works N. Y. C. daytime.
18.135	<b>PMC</b>	<b>BANDOENG, JAVA</b> , 16.54 m. Works Holland mornings.
18.115	<b>LSY3</b>	<b>BUENOS AIRES, ARG.</b> , 16.56 m., Addr. (See 20.700 mc.) Tests irregularly.
18.040	<b>GAB</b>	<b>RUGBY, ENG.</b> , 16.83 m. Works Canada morning and afternoon.
17.810	<b>PCV</b>	<b>KOOTWIJK, HOLLAND</b> , 16.84 m. Works Java 6-8 am.

↓ S.W. BROADCAST BAND ↓

17.790	<b>GSG</b>	<b>DAVENTRY, ENG.</b> , 16.86 m., Addr. B. B. C., London. 12 m.-2.15 am., 5.45-8.55 am., 9 am.-12 n., 12.20-3.45, 4-6, 9-11 pm.
17.785	<b>JZL</b>	<b>TOKIO, JAPAN</b> , 16.87 m. Tests irregularly.
17.780	<b>W3XAL</b>	<b>BOUND BROOK, N. J.</b> , 16.87 m., Addr. Natl. Broad. Co. 8 am.-8 pm.
17.770	<b>PHI</b>	<b>HUIZEN, HOLLAND</b> , 16.88 m., Addr. (See PHI, 11.730 mc.) Daily except Wednesday, 8.25-10 am., Sat. till 10.40 am., Sun. 7.25-10.35 am.
17.760	<b>DJE</b>	<b>BERLIN, GERMANY</b> , 16.89 m., Addr. Broadcasting House. 12.05-5.15 am.; 5.55-11 am. Sun. 11.10 am.-12.25 pm.
17.760	<b>W2XE</b>	<b>NEW YORK, N. Y.</b> , 16.89 m., Addr. Col. Broad. System. 485 Madison Ave.

Mc.	Call	
17.755	<b>ZBW5</b>	<b>HONGKONG, CHINA</b> , 16.9 m., Addr. P. O. Box 200. 4-10 am. irregular.

↑ S.W. BROADCAST BAND ↑

17.741	<b>HSP</b>	<b>BANGKOK, SIAM</b> , 16.91 m. Works Germany 4-7 am.
17.650	<b>XGM</b>	<b>SHANGHAI, CHINA</b> , 17 m. Works London 7-9 am.
17.520	<b>DFB</b>	<b>NAUEN, GERMANY</b> , 17.12 m. Works S. America, near 9.15 am.
17.480	<b>VWY2</b>	<b>KIRKEE, INDIA</b> , 17.16 m. Works London 7.30-8.15 am.
17.120	<b>WOO</b>	<b>OCEAN GATE, N. J.</b> , 17.52 m., Addr. A. T. & T. Co. Works ships irregularly.
17.080	<b>GBC</b>	<b>RUGBY, ENG.</b> , 17.56 m. Works ships irregularly.
16.835	<b>ITK</b>	<b>MOGADISCIO, ITAL. SOMALILAND</b> , 18.32 m. Calls IAC around 9.30 am.
16.270	<b>WLK</b>	<b>LAWRENCEVILLE, N. J.</b> , 18.44 m., Addr. A. T. & T. Co. Works S. Amer. daytime.
16.270	<b>WOG</b>	<b>OCEAN GATE, N. J.</b> , 18.44 m., Addr. A. T. & T. Co. Works England Late afternoon.
16.240	<b>KTO</b>	<b>MANILA, P. I.</b> , 18.47 m., Addr. RCA Contm. Works Japan and U. S. 5-9 pm. irregularly.
16.233	<b>FZR3</b>	<b>SAIGON, INDO-CHINA</b> , 18.48 m. Calls Paris early morning.
16.030	<b>KKP</b>	<b>KAHUKU, HAWAII</b> , 18.71 m., Addr. RCA Comm. Works Dixon 3-10 pm.
15.880	<b>FTK</b>	<b>ST. ASSISE, FRANCE</b> , 18.9 m. Works Saigon 8-11 am.
15.865	<b>CEC</b>	<b>SANTIAGO, CHILE</b> , 18.91 m. Calls Peru daytime irregular.
15.810	<b>LSL</b>	<b>BUENOS AIRES, ARG.</b> , 18.98 m., Addr. (See 21.020 mc.) Works London mornings and Paris afternoons.
15.660	<b>JVE</b>	<b>NAZAKI, JAPAN</b> , 19.16 m. Works Java 3-5 am.
15.520	<b>JVF</b>	<b>NAZAKI, JAPAN</b> , 19.2 m. Works Cal. near 5 am. and 8 pm.
15.450	<b>IUG</b>	<b>ADDIS ABABA, ETHIOPIA</b> , 19.41 m. Works Rome 9.15-10.30 am.
15.440	<b>XEBM</b>	<b>MAZATLAN, SIN., MEX.</b> , 19.43 m., Addr. Flores 103 Alto. "El Pregonero del Pacifico." Irregularly 7 am.-10 pm.
15.415	<b>KWO</b>	<b>DIXON, CAL.</b> , 19.46 m., Addr. A. T. & T. Co. Works Hawaii 2-7 pm.
15.370	<b>HAS3</b>	<b>BUDAPEST, HUNGARY</b> , 19.52 m., Addr. Radiolabor. Gyaly Ut 22. Sun 9-10 am.
15.360	<b>DZG</b>	<b>ZEESEN, GERMANY</b> , 19.53 m., Addr. Reichspostzentralamt. Tests irregularly.
15.355	<b>KWU</b>	<b>DIXON, CALIF.</b> , 19.53 m., Addr. A. T. & T. Co. Phones Pacific Isles and Japan.

↓ S.W. BROADCAST BAND ↓

15.340	<b>DJR</b>	<b>BERLIN, GERMANY</b> , 19.56 m., Addr. Broadcast'g House, 8-9 am., 4.50-10.45 pm.
15.330	<b>W2XAD</b>	<b>SCHENECTADY, N. Y.</b> , 19.56 m., Addr. General Electric Co. Relays WGY 10 am. to 8 pm.
15.310	<b>GSP</b>	<b>DAVENTRY, ENG.</b> , 19.6 m., Addr. (See 26.100 mc.) 6.20-8.30 pm.
15.290	<b>LRU</b>	<b>BUENOS AIRES, ARG.</b> , 19.62 m., Addr. El Mundo. 7-9 am.
15.280	<b>H13X</b>	<b>CIUDAD TRUJILLO, D. R.</b> , 19.63 m., Relays H1X Sun. 7.40-10.40 am. Week-days 12.10-1.10 pm.
15.280	<b>DJQ</b>	<b>BERLIN, GERMANY</b> , 19.63 m., Addr. Broadcasting House. 12.05-5.15, 6-8, 8.15-11 am., 4.50-10.45 pm.
15.270	<b>W2XE</b>	<b>NEW YORK CITY</b> , 19.65 m., Addr. (See 21.520 mc.) 2-5 pm.

(Continued on page 237)



Situation 3-00-13-44  
 Frequency 9.55 mc. (2200)  
 Oscillator  
 Power 5 kw  
 Antenna  
 Modulation and direct  
 Tubes 6F10, 6A6, 6X4, 6AR5  
 Mike  
 Pick-up  
 A.F. ampl.

**SCHEDULE OF TESTS**

**HS-8PJ**

THE EXPERIMENTAL RADIO BROADCASTING STATION  
 AT SALADENG, BANGKOK, SIAM.

With thanks we beg to verify correct your report of  
 reception dated 22-9-37  
 Further reports will always be appreciated.

*Phu Anan*

HS8PJ—This distinctive Siamese QSL verifies both frequencies.

**HAM STARDUST**

Re VAC standings this month, we have not heard from all members as to revisions of their standings, so will give full list next month. New members standings are: Clarence Hartzell, 5 VAC, 58 countries; Roger Legge, Jr.; an OT, rates 16 VAC, 78 countries; Albert Emerson, 10 VAC, 64 countries; W. S. Wade, 5 VAC; Ashley Walcott, 11 VAC.

"SUISG, on approximately 14000 kc., Alexandria, Egypt," as announced during our Special Broadcast was heard here with a terrific signal, far above expectations, and we feel sure all IDA and SW&T readers throughout the U.S.A. had an easy time of it in "logging" this PB catch. All DXers who write Mr. Pettitt should thank him for his kindness and trouble. We were certainly lucky in just making the "deadline" with this flash scoop, and were doubly glad that SW&T readers would know in time about this fine Special. We surely hope all of you heard it, as SUISG sends one of the best ham QSL's ever received here!

OQ5AA, Tondo, Belgian Congo, has confirmed reception here, with an interesting QSL, and it seems that all of our friends have also heard from "Doc," as the missionary, Dr. George W. Westcott, M.D., terms himself. The card is shown in this month's article. OQ5AA is often heard near 14050 in the afternoons, with an unusually strong signal between 3:30 and 5:30 p.m., and, as we suspected, "Doc" uses a beam antenna.

EA9AH, 14004, Tetuan, Spanish Morocco, seems to be on daily, and may be heard anywhere between 3 p.m. and midnight. "pouring in" a powerful signal; usually QSOing Central and South American amateurs.

EA8AE, 14060, Canary Islands, also heard FB, QSOing in Spanish, usually announcing as "Aqui ocho ah ay, Canarias" same times as EA9AH.

CN8AM, "America, Morocco," 14100, at Casablanca, French Morocco, with a FB signal at 5:30 p.m.

CN8AJ, "America Japan," 14120, same QRA as above, also FB, weekends, near 4:30-5:30 p.m.

SUICH, 14320, at Cairo, heard lately at 5:25 p.m. an R9 signal.

ZS5AB, 14060, South Africa, "logged" by Irving Goodeve. QSOing a W1 at 7:10 a.m. This is an unusual time for such DX. Congrats, Irv!!!

Other Africans reported are FT1AA, 14380, R8 at 1 a.m., by Charles Miller and Clarence Hartzell, FT4AN, same "ham" as above, heard at 12:30 a.m. by Murray Buitekant, our Brighton Beach DX Eagle. Also reported are FABGT, 14340; CN8MU, 14130; these in afternoons.

ZE1JF, 14070, Southern Rhodesia, heard at 9:30 a.m.; ZU6N, 14265, lately using (Continued on page 262)

CR7AA and CR7BH have same QRA: Box 594, Lourenco Marques, Mozambique.

**CEYLON**

VPB, Colombo, has confirmed reception report of Ashley Walcott with a fine verification from the Chief Telecommunication Engineer, Broadcasting Office, Torrington Square, Colombo. Along with a letter veri was a copy of the *Ceylon Radio Times*, and also a few Ceylon postage stamps! We intend to write the engineer as soon as we hear VPB, hi!

Data on VPB: 6.16 mc. Schedule: 6:30-11:30 a.m., which must be daily.

**CHINA**

The Chinese commercials are quite active, as almost every morning we can "log" at least 2 X's near 6 a.m.

The following were heard the past month: XTB, 11.415 mc., Shanghai; XTV, 9.49 mc., Canton; XGW, 10.42 mc., Shanghai; XTS, 11.47 mc., Swatow; XTK, 9.08 mc., Hankow; XTR, 9.36 mc., Swatow, all near 6 a.m., before or after, and also XOJ, often heard evenings with JVE, JVF, or KWU, and near 5 a.m. with JVE.

All reports should be sent, with a reply coupon to: Mr. T. C. Loo, *Chinese Gov't. Radio Administration*, Sassoon House, Jinkee Road, Shanghai.

**SWEDEN**

SBG, operating on both 11.705 mc. and 6.095 mc. at Motala, and formerly SM5SX, has the following schedule: Weekdays—11.705 mc., 7-9 a.m., 11 a.m.-1:30 p.m. Sundays—3 a.m.-1:30 p.m. On 6.095 mc., weekdays and Sundays, 1:30-5 p.m.

This data received from SM5SV, OM John Lagercrantz, former builder and operator of SM5SX, the man responsible for the inauguration of international broadcasting in Sweden. John informs us that the Government has taken over SM5SX, and we can safely say that it was entirely due to John's efforts that Sweden today is heard throughout the world. The power of SBG is staged as 700 watts and due to be increased.

**INDO-CHINA**

From Mr. Paul C. Brown, Radio Engineer at Philco Radio, Saigon, comes a letter giving the latest schedule in effect. It is: Daily 11 p.m.-1 a.m.; 5:30-9:30 a.m. Frequency is 11.71 and 6.03 mc., operating simultaneously and each is powered at 250 watts. Power to be increased soon.

Mr. Brown adds that the station is now called "Boy-Landry, Saigon," in announcements. Ashley Walcott adds that of late the lower frequency has been changed from 5.985 mc., to 5.91 mc., and that frequency stability of both frequencies is poor. This station, with a power increase, should be well heard this Fall and Winter.

**ASIATIC REVIEW**

"Erlanger and Gallinger, Inc., Manila, Philippines," heard testing a Xmt on 11.84 mc., 9 p.m.-9 a.m., E.S.T., first heard on June 10 by Ashley Walcott, San Francisco. Ashley adds that station becomes audible

in California at 1:30 a.m., and that station relays KZEG, Manila, until 5:30 or 6 a.m., and KZRM from then until "shutdown." No call letters as yet issued.

TDE, 10.065 mc., Shinkyu, Manchukuo, heard "QSOing" JVO, 10.37 mc., Nazaki, Japan, at 3:35 a.m. These two may be heard daily anywhere between 3-6 a.m., generally.

JIB, 10.53 mc., Taiwan, Formosa, heard using inverted speech at 5:50 a.m. JIB is verified through the regular Tokio address. JVK, 12.02 mc., Nazaki, heard phoning at 6 a.m.

PK6CI, was heard from 6:30-7:30 a.m., while on 20 meter band, in an unusual contact with PNI, 8.775 mc., at Makassar, Celebes Island, Java. This was arranged as an emergency telephone circuit; this from our friend Ashley Walcott.

**DX REVIEW**

VK6ME, 9.59 mc., Perth, Western Australia, has verified to Jim Lanyon and Ashley Walcott, giving power as 5 kw., and schedule daily except Sunday from 6-8 a.m.

VK8SC, 6.96 mc., Port Hedland Western Australia, was heard from 8:30-8:40 a.m. calling listeners in Melbourne and asking that they get in touch with the Postmaster. Sounds like an emergency. This is by courtesy of Ashley Walcott.

ZGB, 13.643 mc., Kuala Lumpur, Federated Malay States, heard irreg. from 7:45-8:15 a.m. phoning PIQ, 10.68 mc., Bandoeng, using inverted speech.

PJCI, 5.93 mc., Willemstad, Curacao, Netherland West Indies, has QSL'd reports of our friends Ed Goss and John DeMeyer, stating schedule to be Monday to Saturday inclusive, 7-9 p.m.

QRA or PJCI is: "Curom." KORTE GOLF ZENDER. PJCI, Willemstad, Curacao, N. W. I.

**QRA. ALEXANDRIA**

To RADIO W2S... This confirms receipt of your card and report on my 14 Mc. FoneSigs

RECEIVER  
 Hammarlund A. C. Pro  
 Xtal Filter & Pre Selector  
 QRG 28, 14.7 & 3.5 Mc.

W. B. E.  
**SUISG**  
 W. A. C.

TRANSMITTER  
 CO. FB. PA.  
 Cpt. 250 Wts. C. W.  
 100 Wts. Class "B" Fone  
 Ant. 132 Ft. Zepp.

Many thanks OM for your report which is most interesting and I hope to hear you on the air soon

Frank A. Pettitt op.  
 R.S.G.B. & A.R.R.L.

SUISG—Red letters, green background make a handsome QSL.



Mc.	Call	Station	Mc.	Call	Station	Mc.	Call	Station
15.260	GS1	DAVENTRY, ENG., 19.66 m., Addr. (See 26.100 mc.) 12.20-3.45, 9-11 pm.	14.500	---	ASMARA, ERITREA, AFRICA, 20.69 m. Works Rome and Addis Ababa 6.30-7.30 am	12.120	TPZ2	ALGIERS, ALGERIA, 24.75 m. Calls Paris 12 m.-6.30 am.
15.252	RIM	TASHKENT, U.S.S.R., 19.67 m. Works RKI near 7 am.	15.500	LSM2	BUENOS AIRES, ARG., 20.69 m., Addr. (See 21.020 mc.) Works RIO and Europe daytime.	12.060	PDV	KOOTWIJK, HOLLAND, 24.88 m. Tests irregularly.
15.250	W1XAL	BOSTON, MASS., 19.67 m., Addr. University Club. Sundays 11 am-12.30 pm. Daily 3.30-4 pm.	14.485	TIR	CARTAGO, COSTA RICA, 20.71 m. Works Central America and U. S.A. daytime.	12.000	RNE	MOSCOW, U.S.S.R., 25 m. Daily 3-6 pm., Sat., Sun., Tues., Thurs., 10.15-10.45 pm., also Sun. 6-11 am., Mon 6-7 am. and 8.30-9 pm. Wed. 6-7 am., Thurs. 8.30-9 pm.
15.245	TPA2	PARIS, FRANCE, 19.68 m., Addr. 98 bis. Blvd. Haussmann. "Radio Colonial." 5-10 am.	14.485	YSL	SAN SALVADOR, SALVADOR, 20.71 m. Irregular.	11.991	FZS2	SAIGON, INDO-CHINA, 25.02 m. Phones Paris mornings.
15.230	HSBPJ	BANGKOK, SIAM, 19.32 m. Irregularly Mon. 8-10 am.	14.485	HPF	PANAMA CITY, PANAMA, 20.71 m. Works WNC daytime.	11.960	HI2X	CIUDAD TRUJILLO, D. R., 25.08 m., Addr. La Voz de Hispaniola. Relays HIX Tue. and Fri. 8.10-10.10 pm.
15.230	OLR5A	PRAGUE, CZECHOSLOVAKIA. Mon. and Thurs., 9-10 pm.	14.485	TGF	GUATEMALA CITY, GUATEMALA, 20.71 m. Works WNC daytime.	11.955	IUC	ADDIS ABABA, ETHIOPIA, 25.09 m. Works IAC around 12 midnight.
15.220	PCJ	HUIZEN, HOLLAND, 19.71 m., Addr. N. V. Philips' Radio, Hilversum. Tues. 4.30-6 am., Wed. 8-11 am.	14.485	YNA	NICARAGUA, MANAGUA, 20.71 m. Works WNC daytime.	11.950	KKQ	BOLINAS, CALIF., 25.1 m. Tests irregularly evenings.
15.210	W8XK	PITTSBURGH, PA., 19.72 m., Addr. (See 21.540 mc.) 9 am.-7 pm.	14.485	HRL5	NACAOME, HONDURAS, 20.71 m. Works WNC daytime.	11.940	FTA	STE. ASSISE, FRANCE, 25.13 m. Works Morocco mornings and Argentina late afternoon.
15.200	DJB	BERLIN, GERMANY, 19.74 m., Addr. (See 15.280 mc.) 12.05-5.15 am., 5.55-11 am., 4.50-11 pm. Also Sun. 11.10 am. to 12.25 pm.	14.485	HRF	TEGUCIGALPA, HONDURAS, 20.71 m. Works WNC daytime.			
15.190	ZBW4	HONGKONG, CHINA, 19.75 m., Addr. P. O. Box 200. 11.30 pm. to 1.15 am. 4-10 am. Sat. 9.15 pm.-1 am. Sun. 3-9.30 am.	14.470	WMF	LAWRENCEVILLE, N. J., 20.73 m., Addr. A. T. & T. Co. Works England daytime.			
15.180	GS0	DAVENTRY, ENG., 19.76 m., Addr. (See 26.100 mc.) 12m.-2.15 am., 4-6, 6.20-8.30 pm.	14.460	DZH	ZEESEN, GERMANY, 20.75 m., Addr. (See 15.360 mc.) Irregular.	11.900	XEW1	MEXICO CITY, MEXICO, 25.21 m. Monday, Wed. and Fri. 3-4 pm., 9 pm.-12 m. Tues. to Thurs. 7.30 pm.-12 m. Sat. 9 pm. to 12 m. Sunday 12.30-2 pm.
15.180	RW9B	MOSCOW, U.S.S.R., 19.76 m., Sun 2-3 pm.	14.440	GBW	RUGBY, ENG., 20.78 m. Works U. S. A. afternoons.	11.895	HP51	AGUADULCE, PANAMA, 25.22 m., Addr. La Voz del Interior. 7.30-9.30 pm-15.245 mc.) 1-4 am., 11.15 am.-5 pm.
15.165	XEWW	MEXICO CITY, MEXICO, 19.78 m. Irregular 9 am.-6 pm.	14.200	EASAH	TETUAN, SPANISH MOROCCO, 21.13 m. Daily except Sun. 2.15-5.7 and 9 pm.	11.880	TPA3	PARIS, FRANCE, 25.23 m., Addr. (See 15.245 mc.) 1-4 am., 11.15 am.-5 pm.
15.160	JZK	TOKIO, JAPAN, 19.79 m., 3-4 pm., 4.30-5.30 pm., 12.30-1.30 am.	13.990	GBA	RUGBY, ENG., 21.44 m., Works Buenos Aires late afternoon.	11.870	W8XK	PITTSBURGH, PA., 25.26 m., Addr. (See 21.540 mc.) 7-10.30 pm.
15.150	YDC	BANDOENG, JAVA, 19.8 m., Addr. N. I. R. O. M. 6-7.30 pm. 10.30 pm.-2 am., Sat. 7.30 pm.-2 am., 5.30-10.30 am.	13.820	SUZ	ABOU ZABAL, EGYPT, 21.71 m. Works with Europe 11 am. to 2 pm.	11.860	YDB	SOERABAJA, JAVA, 25.29 m., Addr. N. I. R. O. M. Sat. 7.30 pm. to 2.30 am., daily 10.30 pm. to 2 am.
15.140	GSF	DAVENTRY, ENG., 19.82 m., Addr. (See 26.100 mc.) 4-6, 6.20-8.30 pm.	13.690	KKZ	BOLINAS, CALIF., 21.91 m., Addr. RCA Communications. Irregular.	11.860	GSE	DAVENTRY, ENG., 25.29 m., Addr. (See 26.100 mc.) Irregular.
15.120	HVJ	VATICAN CITY, 19.83 m., 10.30-10.45 am., except Sun., Sat. 10-10.45 am.	13.635	SPW	WARSAW, POLAND, 22 m., Mon., Wed. Fri., 12.30-1.30 pm.	11.855	DJP	BERLIN, GERMANY, 25.31 m., Addr. (See 15.280 mc.) Irregular 11.35 am. to 4 pm.
15.110	DJL	BERLIN, GERMANY, 19.85 m., Addr. (See 15.280 mc.) 12 m.-2, 8-9 am., 11.35 am. to 4.30 pm. Sun. also 6-8 am.	13.635	SPW	WARSAW, POLAND, 22 m., Mon., Wed. Fri., 12.30-1.30 pm.	11.840	CSW	LISBON, PORT., 25.35 m. Nat'l Broad. Stat. 11.30 am.-1.30 pm.
			13.585	GBB	RUGBY, ENG., 22.08 m. Works Egypt and Canada afternoon.	11.840	OLR4A	PRAGUE, CZECHOSLOVAKIA, 25.35 m. Addr. Czech Shortwave Sta., Praha X11, Fochova 16. Daily 2-4.30 pm., Mon. and Thurs., 7-9 pm.
			13.415	GCJ	RUGBY, ENG., 22.36 m. Works Japan and China early morning.			
			13.410	YSJ	SAN SALVADOR, SALVADOR, 22.37 m. Works WNC daytime.	11.830	W9XAA	CHICAGO, ILL., 25.36 m., Addr. Chicago Federation of Labor. Irregular.
			13.390	WMA	LAWRENCEVILLE, N. J., 22.4 m., Addr. A. T. & T. Co. Works England morning and afternoon.	11.830	W2XE	NEW YORK CITY, 25.36 m., Addr. Col. Broad. System. 485 Madison Av., N.Y.C., relays WABC 6-11 pm.
			13.380	IDU	ASMARA, ERITREA, AFRICA, 22.42 m. Works Rome daytime.	11.820	XEBR	HERMOSILLA, SON., MEX., 25.38 m., Addr. Box 68. Relays XEBH. 2-4 pm., 9 pm.-12m.
			13.345	YVQ	MARACAY, VENEZUELA, 22.48 m. Works WNC daytime.	11.820	GSN	DAVENTRY, ENG., 25.38 m., Addr. (See 26.100 mc.) Irregular.
			13.285	CGA3	DRUMMONDVILLE, QUE., CAN., 22.58 m. Works London and ships afternoons.	11.810	ZRO	ROME, ITALY, 25.4 m., Addr. E.I.R.R., Via Montello 5. Daily 6.43-10.30 am, 11.30 am.-5.30 pm., 6-7.45 pm. Sun. 6.43-9 am., 11.30 am.-5.30 pm.
			13.330	IRJ	ROME, ITALY, 22.69 m. Works Tokio 5-9 am. irregularly.	11.800	JZJ	TOKIO, JAPAN, 25.42 m., Addr. Broadcasting Co. of Japan, Overseas Division. 9-10 am. 3-4, 4.30-5.30 pm.
			13.075	VPD	SUVA, FIJI ISLANDS, 22.94 m. Irregularly.	11.800	OER2	VIENNA, AUSTRIA, 25.42 m. Daily 10 am.-5 pm. Sat. until 5.30 pm.
			12.840	WOO	OCEAN GATE, N. J., 23.36 m. Addr. A. T. & T. Co. Works with ships irregularly.	11.795	DJO	BERLIN, GERMANY, 25.43 m., Addr. (See 15.280 mc.) Irregular.
			12.825	CNR	RABAT, MOROCCO, 23.39 m., Addr. Director General Tele. & Teleg. Stations. Works with Paris irregularly.	11.795	OAX5B	ICA, PERU, 25.43 m., Addr. Radio Universal. 11 am.-12 n. 4-11.15 pm.
			12.800	IAC	PISA, ITALY, 23.45 m. Works Italian ships mornings.	11.790	COGF	MATANZAS, CUBA, 25.45 m., Addr. P. O. Box 51. Relays CMGF.
			12.780	GBC	RUGBY, ENG., 23.47. Works ships irregularly.	11.790	W1XAL	BOSTON, MASS., 25.45 m., Addr. (See 15.250 mc.) Daily 3.30-5.45 pm. Irregular at other times.
			12.485	HIN	CIUDAD TRUJILLO, D. R., 24 m. "Broadcasting National." 12 n.-2 pm. 6-11 pm. approx.	11.770	DJD	BERLIN, GERMANY, 25.49 m., Addr. (See 15.280 mc.) 11.35 am.-4.30 pm., 4.50-11 pm.
			12.325	DAF	NORDEICH, GERMANY, 24.34 m. Works German ships daytime.	11.760	OLR4B	PRAGUE, CZECHOSLOVAKIA, 25.51 m., Addr. (See 11.875 mc.) Irregular.
			12.300	CB615	SANTIAGO, CHILE, 24.39 m., Addr. Louis Desmaras, Casilla, 761. 11 am.-1 pm., 4-8 pm., Sun. 4-10 pm.	11.750	GSD	DAVENTRY, ENG., 25.53 m., Addr. B. B. C., London. 12 m.-2.15 am., 12.20-3.45 pm., 6.20-8.30, 9-11 pm.
			12.290	GBU	RUGBY, ENG., 24.41 m. Works N. Y. C. evenings.	11.730	---	SAIGON, INDO CHINA, 25.57 m., Addr. Radio Phileo. Irregular 5.30-9.30 am.
			12.250	TYB	PARIS, FRANCE, 24.49 m. Irregular.	11.730	PHI	HUIZEN, HOLLAND, 25.57 m., Addr. N. Y. Philips' Radio. Irregular.
			12.235	TFJ	REYKJAVIK, ICELAND, 24.52 m. Works Europe mornings. Broadcasts Sun. 1.40-2.30 pm.			
			12.215	TYA	PARIS, FRANCE, 24.56 m. Works French ships in morning and afternoon.			
			12.150	GBS	RUGBY, ENG., 24.69 m. Works N. Y. C. evenings.			
			12.130	DZE	ZEESEN, GERMANY, 24.73 m., Addr. (See 15.360 mc.) Tests irregular.			

↓ S.W. BROADCAST BAND ↓

↑ S.W. BROADCAST BAND ↑

(All Schedules Eastern Standard Time)

(Continued on page 239)



# How To Identify S-W Stations

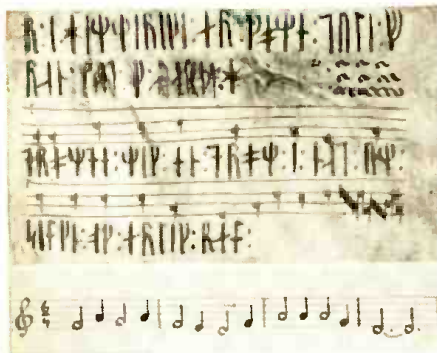

The interesting chart at the top of the cut above shows an ancient musical script dating from the thirteenth century, and it forms the prototype of the musical interval signal used at the Skamleboeak (Denmark) station. The musical notes forming the modern interval signal are also given.

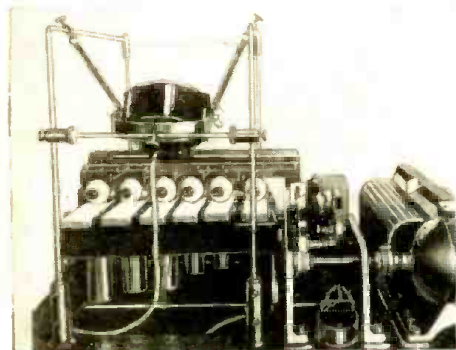

Above—the mechanical device used to produce the musical "identification signal" employed by the Skamleboeak station. It consists of six small hammers which are caused to strike six notes on steel bars in the proper order.

## World-Wide Identification List Part Three

Freq. Mc.	Station Call	Type	Location	Service
11.90	XEWI	B	Mexico City, Mexico.	Announcements in Spanish and English. Slogan: "My Voice to the World from Mexico." Gong struck twice after announcements. Selection opening and closing broadcasts: "May Angels Guard Thee."
11.90	OLR4D	B	Prague, Czechoslovakia.	See OLR6A, 21.45 mc. Irregular.
11.895	HP51	B	Aguadulce Panama.	Slogan: "La Voz Del Interior." Sign-off selection: "El Tambor de La Alegria." Interval signal: 3 notes on gongs; 3 times on half hour and hour.
11.885	TPA3	B	Pontoise, France.	Calls "Allo, Allo, Ici Parea, Station D'etat Radio Coloniale." Anthem "La Marseillaise" opens and ends broadcasts. Intervals: 3 notes in C.W. News

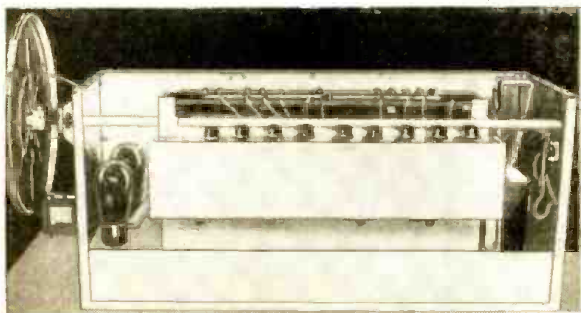

A special electro-magnetic device is employed to produce the musical "interval signal" broadcast periodically by the Belgrade (Yugoslavia) station.

- in 6 languages, including English.
- 11.875 OLR4C B—Prague, Czechoslovakia. See OLR6A, 21.45 mc. Irregular.
- 11.84 OLR4A B—Prague, Czechoslovakia. See OLR6A, 21.45 mc. Regular.
- 11.84 No Call. B—Manila, Philippines. Testing new XMTR, relaying station "KZEG, The Sunshine Station of Manila." Later "KZRM, Radio Manila." Both on BCB.
- 11.826 XEBR B—Hermosillo, Mexico. Slogan: "El Herald de Sonora." Uses dual call "XEBH y XEBR."
- 11.81 2R04 B—Rome, Italy. Call: "Ente Italiano audizioni Radiofonice EIAR." Interval signal: Electrical Bird Call. Opening selection: "Bells of Rome." Woman announcer. Often says "Radio Roma Napoli." Closes with Puccini's "Hymn to Rome," Royal March, and "Giovinezza," the latter being the Fascist anthem.
- 11.81 FIQA B—Tananarive, Madagascar.

Here is the apparatus used for producing the musical "identification signal" used by the station at Budapest, Hungary. It employs a revolving toothed drum and an amplifier.

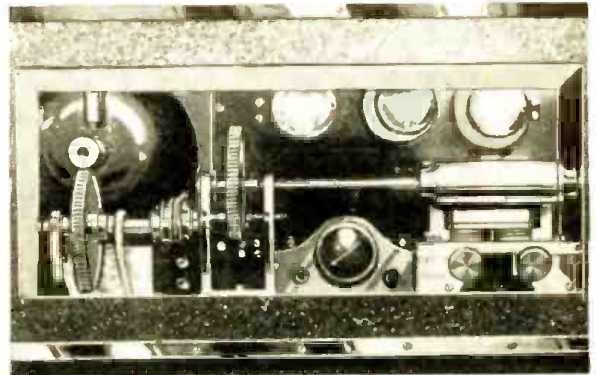

- Approx. freq. Call: "Radio Tananarive." Opens with "Ramona." Closes with "Marseillaise."
- 11.80 JZJ B—Nasaki, Japan. See JZI, 9.535 mc.
- 11.796 OAX5A B—Ica, Peru. Slogan: "Radio Universal. La Voz de Ica."
- 11.79 COGF B—Matanzas, Cuba. Slogan: "La Voz de la Provincia." Uses dual calls CMGF and COGF. Gives call in English as: "COG—as in Georgia, F as in Florida."
- 11.778 OER2 B—Vienna, Austria. "Hier Radio Wien." Uses metronome signal, 60 beats per minute.
- 11.76 OLR4B B—Prague, Czechoslovakia. See OLR6A, 21.45 mc. Irregular.
- 11.74 HP5L B—David, Panama. Slogan: "La Ondas del Baru."
- 11.72 TPA4 B—Pontoise, France. See TPA3, 11.885 mc.

- 11.718 CR7BH B—Lourenco, Marques. Mozambique. All announcements in English and Portuguese. Identification in English at beginning, middle and end of xmission, as follows: "This is Lourenco Marques, CR7AA, calling on 6137 kc., 48.88 meters, and CR7BH, testing on 25.60 meters, 11718 kc." Man announcer weekdays, woman announces in English on Sunday programs. Signs on with various march selections. No set sign-off.
- 11.71 No Call. B—Saigon, Indo-China. Known as "Philco Radio," but lately announced as "Boy-Landry." Xmits Chinese, Anamite and European mu-

- sic. Announcements in French by woman as "Ici Station Boy-Landry, Rue Catinat, Saigon." P. C. Brown, Philco engineer, gives English announcements often. Preceding announcements, made near the half hour, 2 or 3 dozen chimes rung in varying sequence.
- 11.49 COCX B—Havana, Cuba. "La Casa Lavin, La Voz de Radio Philco." Uses Dual Call "CMX y COCX." Opens, closes with native song. 5 bells preceding announcement every quarter hour. English announcements every half hour.
- 11.47 XTS C—Swatow, China. Phones other Chinese cities mornings. Inv. sp. always used.
- 11.415 XTB C—Shanghai, China. See XTS, 11.47 mc.
- 11.402 HBO B and C—Geneva, Switzerland. Phones early a.m. to Australia and sends special BCs also to Australia. For ordinary BCs see HBP, 7.797 mc.
- 11.05 ZLT4 C—Wellington, New Zealand. Identifies at beginning only. Inv. sp. always used. Phones Australia.
- 11.04 CSW B—Lisbon, Portugal. Slogan: "Emisora Nacional."
- 11.00 PLP B—Bandoeng, Java. See YDC, 15.15 mc.



Mc.	Call		Mc.	Call		Mc.	Call	
11.720	CJRX	WINNIPEG, CANADA, 25.6 m., Addr. James Richardson & Sons, Ltd. 4-10pm.	10.290	DZC	ZEESEN, GERMANY, 29.16 m., Addr. (See 15.360 mc.) Irregular.	9.630	HJ2ABD	BUCARAMANGA, COL., 31.14 m. 11.30 am.-12.30 pm., 5.30-6.30, 7.30-10.30 pm.
11.718	CR7RH	LAURENCO MARQUES, PORTUGESE, E. AFRICA, 25.6 m. Daily 4.30-6.30, 9.30-11 am., 12.30-3.30 p.m. Sun. 6-8 am., 10 am.-12.30 pm., 1.30-3.20 pm.	10.260	PMN	BANDOENG, JAVA, 29.24 m., Relays YDB 5.30-10.30 or 11 am., Sat. to 11.30 am.	9.620	HJ1ABP	CARTAGANA, COL., 31.19 m., Addr. P. O. Box 37. 11 am.-1 pm., 5-11 pm. Sun. 10 am.-1 pm., 3-6 pm.
11.715	TPA4	PARIS, FRANCE, 25.61 m., (See 15.245 mc.) 5.15-7.15 pm., 9 pm.-12 m.	10.250	LSK3	BUENOS AIRES, ARG., 29.27 m., Addr. (See 10.310 mc.) Works Europe and U.S.A. afternoons and evenings.	9.615	HP5J	PANAMA CITY, PANAMA, 31.22 m. Addr. Apartado 867. 12 n. to 1.30 pm., 6-10.30 pm.
11.710	SBG	MOTALA, SWEDEN, 25.63 m., 9 am.-1.30 pm.	10.230	CED	ANTOFAGASTAN, CHILE, 29.33 m. Tests 7-9.30 pm.	↓ S.W. BROADCAST BAND ↓		
↑ S.W. BROADCAST BAND ↑			10.220	PSH	RIO DE JANEIRO, BRAZIL, 29.35 m. Irregular.	9.600	RAN	MOSCOW, U.S.S.R., 31.25 m. Daily 7-9.15 pm.
11.680	KIO	KAHUKU, HAWAII, 25.68 m., Addr. RCA Communications. Irregularly.	10.170	RIO	BAKOU, U.S.S.R., 29.15 m. Works Moscow 10 pm.-5 am.	9.600	CB960	SANTIAGO, CHILE, 31.25 m. Heard after 9.30 pm.
11.600	COCX	HAVANA, CUBA, 25.86 m. 8 am.-1 am. Relays CMX.	10.140	OPM	LEDPOLDVILLE, BELGIAN CONGO, 29.59 m. Works Belgium around 3 am. and from 1-4 pm.	9.595	HBL	GENEVA, SWITZERLAND, 31.27 m., Addr. Radio Nations. Irregular.
11.595	VRR4	STONY HILL, JAMAICA, B. W. I., 25.87 m. Works WNC daytime.	10.080	RIO	TIFLIS, U.S.S.R., 29.76 m. Works Moscow early morning.	9.590	PCJ	HUIZEN, HOLLAND, 31.28 m., Addr. (See 15.220 mc.) Sun. 2-3, 7-8 pm. Tues. 1.30-3 pm. Wed. 7-10 pm.
11.560	VIZ3	FISKVILLE, AUSTRALIA, 25.95 m., Addr. Amalgamated Wireless of Australasia Ltd. Tests irregularly.	10.070	EDM-EH Y	MADRID, SPAIN, 29.79 m. Works S. A. evenings.	9.590	VK6ME	PERTH, W. AUSTRALIA, 31.38 m., Addr. Amalgamated Wireless of Australasia, Ltd. 6-8 am. exc. Sun.
11.500	XAM	MERIDA, YUCATAN, 26.09 m. Irregular 1-7.30 pm.	10.065	JZB-TDB	SHINKYO, MANCHUKUO, 29.81 m. Works Tokio 6.30-7 am.	9.590	VK2ME	SYDNEY, AUSTRALIA, 31.38 m., Addr. Amalgamated Wireless of Australasia, Ltd. 4.30-8.30 am., 10.30 am.-12.30 pm.
11.500	PMK	BANDOENG, JAVA, 26.09 m. Tests irregularly.	10.055	ZPB	HAMILTON, BERMUDA, 29.84 m. Works N. Y. C. irregular.	9.590	W3XAU	PHILADELPHIA, PA., 31.28 m. Relays WCAU 11 am. to 7 pm.
11.413	CJA4	DRUMMONDVILLE, QUE., CAN., 26.28 m. Tests irregularly.	10.055	SUV	ABOU ZABAL, EGYPT, 29.84 m. Works Europe 1-6 pm.	9.580	GSC	DAVENTRY, ENGLAND, 31.32 m., Addr. B. B. C., London.
11.405	HBO	GENEVA, SWITZERLAND, 26.30 m., Addr. Radio Nations. Sat. 5.30-6.15, 7-8.30 pm.	10.042	DZB	ZEESEN, GERMANY, 29.87 m., Addr. Reichspostzenstralamt. Irregular.	9.580	VK3LR	MELBOURNE, AUSTRALIA, 31.32 m., Addr. 61 Little Collins St. Daily 3.30-8.30 am. Sun. 3.30-7.30 am. Sun., Fri. 9.30 pm.-2.30 am.
11.280	HIN	CIUDAD TRUJILLO, D. R., 26 m., Addr. La Voz del Partido Dominicano. Irregular.	9.990	KAZ	MANILA, P. I., 30.03 m., Addr. RCA Communications. Works Java early morning.	9.575	HJ2ABC	CUCUTA, COL., 31.34 m. 8 pm. to 12 m.
11.050	ZLT4	WELLINGTON, NEW ZEALAND, 27.15 m. Works Australia and England early morning.	9.950	GCU	RUGBY, ENGLAND, 30.15 m. Works N. Y. C. night time.	9.570	W1XK	SPRINGFIELD, MASS., 31.35 m., Addr. Westinghouse Electric & Mfg. Co. Relays WBZ 6 am. to 12 m. Sun. 7 am. to 12 m.
11.040	CSW	LISBON, PORTUGAL, 27.17 m., Addr. Nat. Broadcasting Sta. 1.30-5 pm.	9.930	HKB	BOGOTA, COL., 30.21 m. Works Rio evenings.	9.560	DJA	BERLIN, GERMANY, 31.38 m., Addr. Broadcasting House. 12.05-5.15 am., 4.50-10.45 pm.
11.000	PLP	BANDOENG, JAVA, 27.27 m. Relays YDB. 5.30-10.30 or 11 am. Sat. until 11.30 am.	9.930	CSW	LISBON, PORTUGAL, 30.31 m., Addr. Nat. Broad. Station. 5-7 pm.	9.555	HJ1ABB	BARRANQUILLA, COL., 31.39 m., Addr. P. O. Box 715. 11.30 am. to 1 pm., 4.30-6 pm.
10.970	OCI	LIMA, PERU, 27.35 m. Works Bogota, Col. evenings.	9.890	LSN	BUENOS AIRES, ARG., 30.33 m., Addr. (See 10.300 mc.) Works N. Y. C. evenings.	9.550	OLR3A	PRAGUE, CZECHOSLOVAKIA, 31.41 m. See 11.840 mc.
10.840	KWV	DIXON, CALIF., 27.68 m., Addr. A. T. & T. Co. Works with Hawaii evenings.	9.870	WON	LAWRENCEVILLE, N. J., 30.4 m., Addr. A. T. & T. Co. Works England nights.	9.540	DJN	BERLIN, GERMANY, 31.45 m., Addr. (See 9.560 mc.) 12.05-5.15 am., 4.50-10.45 pm.
10.770	GBP	RUGBY, ENGLAND, 27.85 m. Works Australia early morning.	9.860	EAQ	MADRID, SPAIN, 30.43 m., Addr. Post Office Box 951. Daily 5.15-7.30 pm., Sat. also 12 n.-2 pm.	9.540	VPD2	SUVA, FIJI ISLANDS, 31.45 m., Addr. Amalgamated Wireless of Australasia, Ltd. 5.30-7 am.
10.740	JVM	NAZAKI, JAPAN, 27.93 m. Works U.S.A. 2-7 am. Broadcasts daily 9-10 am., 2.30-3.30 pm.	9.830	IRM	ROME, ITALY, 30.52 m. Works Egypt afternoons.	9.535	JZI	TOKIO, JAPAN, 31.46 m., Addr. (See 11.800. JZI) 9-10 am.
10.675	WNB	LAWRENCEVILLE, N. J., 28.1 m., Addr. A. T. & T. Co. Works with Bermuda irregularly.	9.800	LSI	BUENOS AIRES, ARG., 30.61 m., Addr. (See 10.350 mc.) Tests irregularly.	9.530	W2XAF	SCHENECTADY, N. Y., 31.48 m., Addr. General Electric Co. 4 pm.-12 m.
10.670	CEC	SANTIAGO, CHILE, 28.12 m. Daily 7-7.15 pm.	9.790	GCW	RUGBY, ENGLAND, 30.64 m. Works N. Y. C. evenings.	9.525	ZBW3	HONGKONG, CHINA, 31.49 m., Addr. P. O. Box 200. Irregular 11.30 pm. to 1.15 am., 4-10 am.
10.660	JVN	NAZAKI, JAPAN, 28.14 m. Broadcasts daily 2-8 am. Works Europe irregularly at other times.	9.760	VLJ-VLZ2	SYDNEY, AUSTRALIA, 30.74 m., Addr. Amalgamated Wireless of Australasia Ltd. Works Java and New Zealand early morning.	9.525	LKJ1	JELOY, NORWAY, 31.29 m. 5-8 am.
10.550	WOK	LAWRENCEVILLE, N. J., 28.44 m., Addr. A. T. & T. Co. Works S. A. nights.	9.750	WOF	LAWRENCEVILLE, N. J., 30.77 m., Addr. A. T. & T. Co. Works London, night time.	9.520	HJ4ABH	ARMENIA, COLOMBIA, 31.51 m. 8-11 am., 6-10 pm.
10.535	JIB	TAIWAN, FORMOSA, 28.48 m. Works Japan around 6.25 am.	9.740	COCQ	HAVANA, CUBA, 30.78 m. 6.50 am. 1 am.	9.510	VK3ME	MELBOURNE, AUSTRALIA, 31.55 m., Addr. Amalgamated Wireless of Australasia. 167 Queen St. Daily except Sun. 4-7 am.
10.520	VLK	SYDNEY, AUSTRALIA, 28.51 m., Addr. Amalgamated Wireless of Australasia Ltd. Works England 1-6 am.	9.710	GCA	RUGBY, ENGLAND, 30.89 m. Works S. A. evenings.	9.510	G8B	DAVENTRY, ENGLAND, 31.55 m., Addr. (See 9.580 mc.—G8C) 12 m.-2.15 am., 12.20-6 pm., 9-11 pm.
10.430	YBG	MEDAN, SUMATRA, 28.76 m. 5.30-6.30 am., 7.30-8.30 pm.	9.675	DZA	ZEESEN, GERMANY, 31.01 m., Addr. (See 10.042 mc.) Irregular.	9.505	HJ1ABE	CARTAGENA, COLOMBIA, 31.57 m., Addr. P. O. Box 31. 5-10.30 pm.
10.420	XGW	SHANGHAI, CHINA, 28.79 m. Works Japan 12 m.-3 am.	9.670	TI4NRH	HEREDIA, COSTA RICA, 31.02 m., Addr. Amando C. Marin, Apartado 40. 8.30-10 pm., 11.30 pm.-12 m.	9.500	XEW W	MEXICO CITY, MEX., 31.58 m., Addr. Apart. 2516. Relays XEW.
10.410	PDK	KOOTWIJK, HOLLAND, 28.8 m. Works Java 7.30-9.40 am.	9.660	LRX	BUENOS AIRES, ARG., 31.06 m., Addr. El Mundo. 9.30 am.-11.30 pm.	9.500	HJU	BUENAVENTURA, COLOMBIA, 31.58 m., Addr. National Railways. Mon., Wed. and Fri. 8-11 pm.
10.410	KES	BOLINAS, CALIF., 28.8 m., Addr. RCA Communications. Irregular.	9.650	CT1AA	LISBON, PORTUGAL, 31.09 m., Addr. Radio Colonial. Tues., Thurs. and Sat. 3.30-6 pm.	9.500	PRF5	RIO DE JANEIRO, BRAZ., 31.58 m. Irregularly 4.45 to 5.45 pm.
10.370	JVO	NAZAKI, JAPAN, 28.93 m. Broadcasts around 5 am.	9.650	YDB	SOERABAJA, JAVA, 31.09 m., Addr. N. I. R. O. M. Daily except Sat. 6-7.30 pm., 5.30 to 10.30 or 11 pm. Sat. 5.30-11.30 am.	9.500	EAR-EAQ2	MADRID, SPAIN, 31.58 m., Addr. (See 9.860 mc.) Exc. Mon. 2.30-3, 6.30-7, 7.30-9.30 pm., Mon. 7.30-9.30 pm.
10.370	EHZ	TENERIFFE, CANARY ISLANDS, 28.93 m. Relays EA443 2.15-3.15, 6.15-9.	9.645	HH3W	PORT-AU-PRINCE, HAITI, 31.1 m., Addr. P. O. Box A117. 1-2, 7-8 pm.	↑ S.W. BROADCAST BAND ↑		
10.350	LSX	BUENOS AIRES, ARG., 28.98 m., Addr. Transradio International. Broadcasts 5-6 pm. Mon. and Fri. Tests irregularly at other times.	9.645	YNLF	MANAGUA, NICARAGUA, 31.1 m. 8-9 am., 12.30-2.30, 6.30-10 pm.	(Continued on page 241)		
10.330	ORK	RUYSELEDE, BELGIUM, 29.04 m. 1.30-3 pm.	9.635	ZRO	ROME, ITALY, 31.13 m., Addr. (See 11.810 mc.) Mon., Wed. and Fri. 6-7.30 pm. Tues., Thurs. and Sat. 6-7.45 pm.			
10.300	LSL2	BUENOS AIRES, ARG., 29.13 m., Addr. Cia. Internacional de Radio. Works Europe evenings.						



# SHORT WAVES and LONG WAVES

## Our Readers Forum



Layton Bennett of Forest Grove, Oregon, owns and operates this fine looking "Ham" station.

### He Enjoyed Our "Ham" Course

**Editor, SHORT WAVE & TELEVISION:**  
Have been picking UR FB magazine from the newsstands ever since I spotted it about two years ago, when I became interested in Radio! I enjoyed the Ham Radio Course by W2AMN and it sure helped me progress towards a better station, ever since I got my "ticket" about a year ago.

I started out with a 6L6 crystal oscillator and worked forty meters for some time with just the *exciter* of the present "rig." The 6L6 is now driving an RK20 "final" to about 100 watts. Am using an 80 meter Zepp antenna and the rig puts out and pulls in very good reports on 20 meters when using a 20 meter crystal; she "socks out" a little more on 40 and better still on 80 meters. 160 meters hasn't been tried as yet, but is going to be taken in as soon as possible.

The receiver whose end just shows is a T-R-F job, using a 58 radio frequency, a 58 detector and a 56 audio.

The whole receiver and transmitter is all home-made. The rack was made from a pair of bed longers, which were in the form of a right-angle of which the knobs on the end were hacked off. The panels are the standard 19 inch, bought at a sheet-metal works. They will probably be crackle finished later on. There are two panels left blank at the top for "future expansion" or for a modulator.

Layton Bennett  
325 Fifth St.,  
Forest Grove, Ore.

*(Good work, Layton, and a neat-looking line-up. Let's hear more from you. Our readers will be glad to know that the "Ham" or Radio Amateur Course will soon be available in book form.—Editor.)*

### VK4FE, an "Aussie," Built His Rig From Our Data!

**Editor, SHORT WAVE & TELEVISION:**  
As a constant reader of your very F.B. (fine business) magazine, I watch with keen interest the pictures of "Ham" transmitters, and herewith submit photo of my "rig."

The entire "rig" was built from data given in your magazine. On the bottom shelf are the power supplies for the oscillator, bias and P.A. Second shelf, the speech amplifier, the modulator and the power-supply for the same. The third shelf contains the 46 oscillator and 46 doubler; the top panel contains two 210's in parallel

and aerial set-up. The P.A. is modulated by a single 2A5, used as a triode in series modulation and it is surprising the way I can pick up the sticks with it! I work mostly on 7,205 kc. but often QSY to 14,120 kc.

The receiver I use is one that was built from your magazine, and is a 4-tube T.R.F. using a 58 in the R.F., a 57 as an electron coupled detector; a 56 first audio, driving a 2A5 for speaker operation.

As you are aware, the Australian amateurs are only allowed 25-watts, so I am only using about 24.5 watts.

While I do no DXing on fone, which I keep for local "rag-chews," I am always anxious for it on C.W.

On the shelf above the receiver I have a stack of "S.W. & T.'s," which are indexed in a separate book for quick reference.

Wishing you and your magazine every success,

Yours faithfully,  
Arthur R. Burton, VK4FE  
33 Leichardt St.,  
Brisbane,  
Queensland, Australia.

*Glad to hear from a "VK"—and especially pleased to hear that you found our construction data of service.—Editor.*

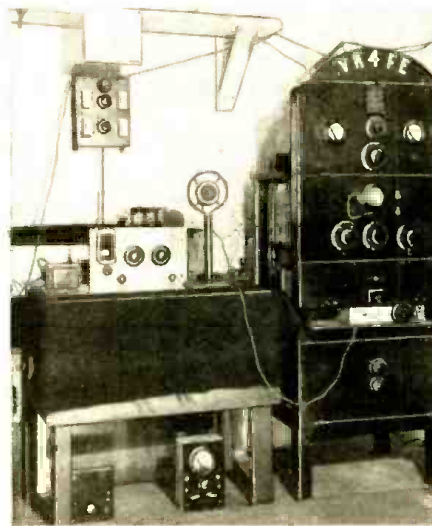

A dandy amateur transmitting and receiving station—VK4FE, "down under" in Brisbane, Australia.

### He Answers Letters; No Reply! Why?

**Editor, SHORT WAVE & TELEVISION:**  
Since you printed my letter in the magazine, I have had about a score of letters from people in different states in America. From Texas, Massachusetts, Wisconsin, New York, Mississippi, Ohio and many more, all asking me if I could oblige them with different things, including information such as prices of different types of tubes, catalogs, photos of sets, prices of commodities for making sets, blueprints of short wave sets used over here (England), blueprints of long and medium wave sets, views of Sheffield (so they could see what it looked like) and pictures of its products.

Well sir, I have answered every letter that was sent and besides sending what they asked for, I sent each one of them three magazines (the one we use here), together with a little present, such as a  
*(Continued on page 250)*

### A "Live" Philadelphia S-W Listening Post

**Editor, SHORT WAVE & TELEVISION:**  
I herewith submit a photo of my Short Wave Listening Post W3-"SWL." (My own call-letter combination.)

Here is a description of my "shack"; A two tube converter in connection with an eight-tube Majestic broadcast receiver. With this receiver I have logged many foreign stations with veris from: HVJ, Vatican City, DJA, Zessen, Germany, YV2RC, Caracas, Venezuela. Amateur veris from, EA4AO, Madrid, Spain, G5ML and G5VN, England, ON4DX, Belgium, K6CRU and K6JUY, Hawaiian Islands, OZ2M, Denmark, KA1XA, Philippine Islands, HB9AQ, Switzerland, SP1DE, Poland, GI5QX, Ireland, K5AC, Canal Zone, HP1A, Panama, X1AY, Mexico, K4DDH, Puerto Rico, CM2RA, CM6RC, Cuba. Also veris from Naval Stations NPM, NAA, NSS, NPG and N1O. Also police and ship veris, and about 125 broadcast stations.

The four-tube long and short wave receiver, which is between the converter and Majestic broadcast receiver, is used for regular broadcast and police reception and also is used for phonographic pick-up and "home broadcasting."

To the extreme right of the photo is my so called, "transmitter," which is a rack-and-panel job. It houses a code oscillator for code practice; an old battery receiver for amplifying the code oscillator signals for speaker reception, wave-traps for long and short wave reception, etc.

I am a member of the *Short Wave League*, R-9 Listeners League, Radio Explorers Club and the Philadelphia Short Wave Club.

I would like to exchange photos and SWL cards with anyone caring to do so. I will also send to anyone a souvenir of Philadelphia in honor of the "Constitution Celebration," the 150th Anniversary of the signing of the Constitution, providing they will enclose a 3c stamp along with their SWL or QSL cards and photo. All mail received by me will be answered.

*Short Wave & Television* magazine is the only radio publication that is used here at my shack, and believe me it sure is swell.

Frank J. Schrameyer, Opr.  
1510 North 26th St.,  
Philadelphia, Penna.



Boy! What a "flock" of veri cards Frank has collected.



Mc.	Call	Location, Time	Mc.	Call	Location, Time	Mc.	Call	Location, Time
9.490	XEFT	VERA CRUZ, MEXICO, 31.61 m. 11.30 am. to 4 pm., 7 pm. to 12 m.	7.975	HC2TC	QUITO, ECUADOR, 37.62 m. Thurs. and Sun. at 8 pm.	6.625	PRADO	RIOBAMBA, ECUADOR, 45.28 m. Thurs. 9-11.45 pm.
9.470	XEDQ	GUADALAJARO, GAL., MEXICO, 31.68 m. Irregular 7.30 pm. to 12.30 am.	7.901	LSL	HURLINGHAM, ARGENTINA, 37.97 m. Works Brazil at night.	6.558	HIAD	CIUDAD TRUJILLO, D. R., 45.74 m. Except Sun. 11.55 am.-1.40 pm.
9.460	ICK	TRIPOLI, N. AFRICA, 31.71 m. Works Rome, 5.30-7 am.	7.860	SUX	ABOU ZABAL, EGYPT, 38.17 m. Works with Europe, 4-6 pm.	6.550	XBC	VERA CRUZ, MEX., 45.8 m. 8.15-9 am.
9.450	TGWA	GUATEMALA CITY, GUATEMALA, 31.75 m., Addr. Ministere de Fomento. Daily 12 n. to 2 pm., 8 pm. to 12 m. Sat. 9 pm. to 5 am. (Sun.)	7.854	HC2JSB	GUAYAQUIL, ECUADOR, 38.2 m. Evenings.	6.550	TIRCC	SAN JOSE, COSTA RICA, 45.8 m., Addr. Radioemisora Catolica Costarricense. Sun. 11 am.-2 pm., 6-7, 8-9 pm. Daily 12 n.-2 pm., 6-7 pm., Thurs. 6-11 pm. Addr. "Ecos de Orinoco." 6-10.30 pm.
9.440	FZF5	FORT DE FRANCE, MARTINIQUE, 31.78 m. 11.30 am., 12.30 pm., 6.15-7.15 pm., 8-9 pm.	7.799	HBP	GENEVA, SWITZERLAND, 38.47 m., Addr. Radio-Nations. Irregular.	6.545	YV6RB	BOLIVAR, VENEZUELA, 45.84 m., Addr. "Ecos de Orinoco." 6-10.30 pm.
9.440	HC2RA	GUAYAQUIL, ECUADOR, 31.78 m. Irregularly till 10.40 pm.	7.715	KEE	BOLINAS, CAL., 38.89 m. Relays NBC and CBS programs in evening irregularly.	6.530	YN1GG	MANAGUA, NICARAGUA, 45.94 m., Addr. "La Voz de los Lagos." 8-9 pm.
9.428	COCH	HAVANA, CUBA, 31.8 m., Addr. 2 B St., Vedado. 7 am.-1 am.	7.626	RIM	TACHKENT, U.S.S.R., 39.34 m. Works with Moscow in early morning.	6.520	YV4RB	VALENCIA, VENEZUELA, 46.01 m. 11 am.-2 pm., 5-10 pm.
9.415	PLV	BANDOENG, JAVA, 31.87 m. Works Holland around 9.45 am.	7.610	KWX	DIXON, CAL., 39.42 m. Works with Hawaii, Philippines, Java and Japan, nights.	6.500	HIL	CIUDAD TRUJILLO, O. R., 46.15 m., Addr. Apartado 623. 12.10-1.40 pm., 5.40-7.40 pm.
9.363	COBC	HAVANA, CUBA, 32.03 m. Addr. Maximo Gomez No. 139. Relays CMBC.	7.650	TIBWS	PUNTA ARENAS, COSTA RICA, 39.74 m., Addr. "Ecos Del Pacifico", P. O. Box 75. 6 pm.-12 m.	6.500	TIOW	PUERTO LIMON, COSTA RICA, 46.15 m., Addr. Ondas del Caribe. Daily 12 n.-1.30 pm.
9.350	HS8PJ	BANGKOK, SIAM, 32.09 m. Thursday, 8-10 am.	7.520	KKH	KAHUKU, HAWAII, 39.89 m. Works with Dixon and broadcasts irregularly nights.	6.477	HI4V	SAN FRANCISCO de MACORIS, D. R., 46.32 m. 11.40 am.-1.40 pm., 5.10-9.40 pm.
9.330	CGA4	DRUMMONDVILLE, CANADA, 32.15 m. Works England irregularly.	7.510	JVP	NAZAKI, JAPAN, 39.95 m. Irregular.	6.470	YNLAT	GRANADA, NICARAGUA, 46.36 m., Addr. Leonidas Tenorio, "La Voz del Mombacho." Irregular.
9.330	OAX4J	LIMA, PERU, 32.15 m., Addr. Box 1166, "Radio Universal." 7 pm.-12 m.	7.500	RKI	MOSCOW, U.S.S.R., 40 m. Works with RIM early am.	6.450	H18A	CIUDAD TRUJILLO, O. R., 46.51 m. 8.40-10.40 am., 2.40-4.10 pm. Sat. 9.40-10.40 pm. Sun. 2.40-4.40 pm.
9.300	YNGU	MANAGUA, NICARAGUA, 32.26 m. 12 n.-2 pm., 6-7 pm.	7.390	ZLT2	WELLINGTON, N. Z., 40.6 m. Works with Sydney, 3-7 am.	6.420	HI1S	SANTIAGO, D. R., 46.73 m. 11.40 am.-1.40 pm., 5.40-7.40, 9.40-11.40 pm.
9.280	GCB	RUGBY, ENGLAND, 32.33 m. Works Canada and Egypt evenings and afternoons.	7.380	XECR	MEXICO CITY, MEX., 40.65 m., Addr. Foreign Office. Sunday 6-7 pm.	6.410	TIPG	SAN JOSE, COSTA RICA, 46.8 m., Addr. Apartado 225, "La Voz de la Victor." 12 n.-2 pm., 6-11.30 pm.
9.170	WNA	LAWRENCEVILLE, N. J., 32.72 m. Works England evenings.	7.220	HKE	BOGOTA, COL., S. A., 41.55 m. Tues. and Sat. 8-9 pm. Mon. and Thurs. 6.30-7 pm.	6.400	YV5RH	CARACAS, VENEZUELA, 46.88 m. 7-11 pm.
9.150	YVR	MARACAY, VENEZUELA, 32.79 m. Works with Europe afternoons.	7.200	YNAM	MANAGUA, NICARAGUA, 41.67 m. Daily at 9 pm.	6.380	YV5RF	CARACAS, VENEZUELA, 47.02 m., Addr. Box 983. 6-10.30 pm.
9.125	HAT4	BUOAPEST, HUNGARY, 32.88 m., Addr. "Radiolabor," Gyali-ut, 22. Sun. and Wed. 7-8 pm., Sat. 6-7 pm.	7.100	FO8AA	PAPEETE, TAHITI, 42.25 m., Addr. Radio Club Papeete. Tues. and Fri. 11 pm.-12 m.	6.360	HRP1	SAN PEDRO SULA, HONDURAS, 47.19 m. 7.30-9.30 pm.
9.060	TFK	REYKJAVIK, ICELAND, 33.11 m. Works London afternoons.	6.996	PZH	PARAMIRABO, DUTCH GUIANA, 42.88 m., Addr. P. O. Box 18. Daily 6.06-8.36 am., Sun. 9.36-11.36 am., Daily 5.36-8.36 pm.	6.360	YV1RH	MARACAIBO, VENEZUELA, 47.19 m., Addr. "Ondas Del Lago," Apartado de Correos 261. 6-7.30 am., 11 am.-2 pm., 5-11 pm.
9.020	GCS	RUGBY, ENGLAND, 33.26 m. Works N. Y. C. evenings.	6.977	XBA	TACUBAYA, D. F., MEX., 43 m. 9.30 am.-1 pm., 7-8.30 pm.	6.350	HRY	TEGUCIGALPA, HONDURAS, 47.24 m. 6.30-8.30 pm.
9.010	KEJ	BOLINAS, CAL., 33.3 m. Relays NBC and CBS programs in evening irregularly.	6.976	HCETC	QUITO, ECUADOR, 43m., Addr. Teatro Bolivar. Thurs. till 9.30 pm.	6.340	HI1X	CIUDAD TRUJILLO, D. R., 49.32 m. Sun. 7.40-10.40 am., daily 12.10-1.10 pm., Tues. and Fri. 8.10-10.10 pm.
8.957	VWY	KIRKEE, INDIA, 33.43 m. Works with England in morning.	6.905	GDS	RUGBY, ENG., 43.45 m. Works N.Y.C. evenings irregularly.	6.316	HIZ	CIUDAD TRUJILLO, D. R., 47.5 m. Daily except Sat. and Sun. 11.10 am.-2.25 pm., 5.10-8.40 pm. Sat. 5.10-11.10 pm. Sun. 11.40 am.-1.40 pm.
8.960	TPZ	ALGIERS, ALGERIA, 33.48 m. Works Paris afternoons.	6.860	KEL	BOLINAS, CALIF., 43.70 m. Tests irregularly. 11 am.-12 n., 6-9 pm.	6.310	TG2	GUATEMALA CITY, GUAT., 47.55 m., Addr. Secretaria de Fomento. Relays TGI 11 pm.-1 am.
8.950	HCJB	QUITO, ECUADOR, 33.5 m. 7-10 pm. except Monday.	6.850	XGOX	NANKING, CHINA, 43.8 m. Daily 6.40-8.40 am., Sun. 4.40-6.05 am.	6.300	YV4RO	MARACAY, VENEZUELA, 47.62 m. 8-10.30 pm.
8.795	HKV	BOGOTA, COLOMBIA, 34.09 m. Mod. and Thurs. 7-7.30 pm.	6.800	HI7P	CIUDAD TRUJILLO, DOM. REP., 44.12 m., Addr. Emisoría Diaria de Comercio. Daily exc. Sat. and Sun. 12.40-1.40, 6.40-8.40 pm. Sat. 12.40-1.40 pm. Sun. 10.40 am.-11.40 am.	6.282	COHB	SANCTI SPIRITUS, CUBA, 47.76 m., Addr. P. O. Box 85. 4-6, 9-11 pm.
8.775	PNI	MAKASSER, CELEBES, N. I., 34.19 m. Works Java around 4 am.	6.770	HIH	SAN PEDRO DE MACORIS, DOM. REP., 44.26 m. 12.10-1.40 pm., 7.30-9 pm. Sun. 3-4 am., 4.15-6 pm., 4.40-7.40 pm.	6.280	HIQ	CIUDAD TRUJILLO, D. R., 47.77 m. 7.10-8.40 am., 12.40-2.10, 8.10-9.40 pm.
8.765	DAF	NORDDEICH, GERMANY, 34.23 m. Works German ships irregularly.	6.750	JVT	LAWRENCEVILLE, N. J., 44.41 m., Addr. A. T. & T. Co. Works England evenings.	6.270	YV5RP	CARACAS, VENEZUELA, 47.79 m., Addr. "La Voz de la Philco." Irregular.
8.760	GCQ	RUGBY, ENGLAND, 34.25 m. Works Africa afternoons.	6.730	HISC	LA ROMANA, DOM. REP., 44.58 m., Addr. "La Voz de la Feria." 12.30-2 pm., 5-6 pm.	6.243	HIN	CIUDAD TRUJILLO, D. R., 48 m., Addr. "La Voz del Partido Dominicano." 12 m.-2 pm., 7.30-9.30 pm., irregularly.
8.750	FZES	DJIBOUTI, FR. SOMALILAND, AFRICA, 34.29 m. Works Paris around 2.30 am.	6.720	PMH	BANDOENG, JAVA, 44.64 m. Relays NIROM programs. 5.30-9 am.	6.235	HRD	LA CEIBA, HONDURAS, 48.12 m., Addr. "La Voz de Atlantida." 8-11 pm.; Sat. 8 pm.-1 am.; Sun. 4-6 pm.
8.730	GCI	RUGBY, ENGLAND, 34.36 m. Works India 8 am.	6.710	TIEP	SAN JOSE, COSTA RICA, 44.71 m., Addr. Apartado 257, La Voz del Tropic. Daily 7-10 pm.	6.230	YV1RG	VALERA, VENEZUELA, 48.15 m. 6-9.30 pm.
8.720	VPD3	SUVA, FIJI ISLES, 34 m., Addr. (See 9.540 mc., VPD2). 5.30-7 am.	6.672	YVQ	MARACAY, VENEZUELA, 44.95 m. Sat. 8-9 pm.	6.230	OAX4G	LIMA, PERU, 48.15 m., Addr. Apartado 1242. Daily 7-10.30 pm.
8.680	GBC	RUGBY, ENGLAND, 34.56 m. Works ships irregularly.	6.670	HC2RL	GUAYAQUIL, ECUADOR, S. A., 44.95 m., Addr. P. O. Box 759. Sun. 5.45-7.45 pm., Tues. 9.15-11.15 pm.	6.210	YV5RI	CORO, VENEZUELA, 48.31 m., Addr. Roger Leyba, care A. Urbina y Cia. Irregular.
8.665	COJK	CAMAGUEY, CUBA, 34.62 m., Addr. 4 General Gomez. 5.30-6.30, 8-11 pm., daily except Sat. and Sun.	6.650	IAC	PISA, ITALY, 45.11 m. Works ships irregularly.	6.190	HI8Q	CIUDAD TRUJILLO, D. R., 48.47 m. 11.45 am.-1 pm., 4.45-6.45 pm.
8.590	YNLQ	MANAGUA, NICARAGUA, 34.92 m. 7.30-9.30 pm.	6.630	HIT	CIUDAD TRUJILLO, D. R., 45.25 m., Addr. "La Voz de la RCA Victor," Apartado 1105. Daily exc. Sun. 12.10-1.40 pm., 5.40-8.40 pm.; also Sat. 10.40 pm.-12.40 am.	6.185	HI1A	SANTIAGO, D. R., 48.5 m., Addr. P. O. Box 423. 11.40 am.-1.40 pm.; 7.40-9.40 pm.; Wed. 6-10.30 pm.
8.580	WOO	OCEAN GAYE, N. J., 35.05 m. Works ships irregularly.				6.171	XEXA	MEXICO CITY, MEX., 48.61 m., Addr. Dept. of Education. 7-11 pm.
3.100	HC2CW	QUAYAQUIL, ECUADOR, 35.71 m. 11.30 am.-12.30 pm., 8-11 pm.						
8.380	IAC	PISA, ITALY, 35.8 m. Works Italian ships irregularly.						
8.190	XEME	MERIDA, YUCATAN, 36.63 m., Addr. Calle 59, No. 517, "La Voz de Yucatan desde Merida." 10 am.-12 n., 6 pm.-12 m.						
8.185	PSK	RIO DE JANEIRO, BRAZIL, 36.65 m. Irregularly.						
8.036	CNR	RABAT, MOROCCO, 37.33 m. Sun. 2.30-5 pm.						

(Continued on page 243)

(All Schedules Eastern Standard Time)



# New S-W Apparatus of Interest to HAMS

## NEW CRYSTAL MIKE



No. 636

● In the photograph we see a reproduction of one of the latest crystal microphones. This is a sound-cell proposition known as B-1. It is very similar to the former Brush BR2S in electrical characteristics. However, as can be seen in the photograph, it has a much different appearance. The dimensions are 3 1/2 inches long, 1 1/2 inches wide, by 1/2 inch thick, and the net weight is 11 ounces. It is furnished complete with a locking type plug and socket-connector for convenience of installation.

This article has been prepared from data supplied by courtesy of the Brush Development Company.

## Dual Trim-Air Condensers

● THESE new standard double-section Trim-Air condensers are constructed with sturdy, over-size double bearings and are selling for less than the cost of two individual units. They can be furnished either with a circular shield as illustrated in this ER-25-AD model, or with a square shield that is removable from the nicked brass tie-rods. A 1/4-inch shaft extends at the rear for additional "ganging." This midget is so constructed as to allow for any of four convenient methods of mounting. Isolantite insulation is employed and the condensers are available in ten standard sizes.

This article has been prepared from data supplied by courtesy of Allen D. Cardwell Mfg. Corp.

## New Transmitting Condensers

● THE accompanying picture shows two types of transmitting condensers recently made available for amateur and commercial use. The rotor and stator plates are stamped from a special grade of aluminum .051 inch thick and all edges are perfectly rounded to eliminate corona discharge.

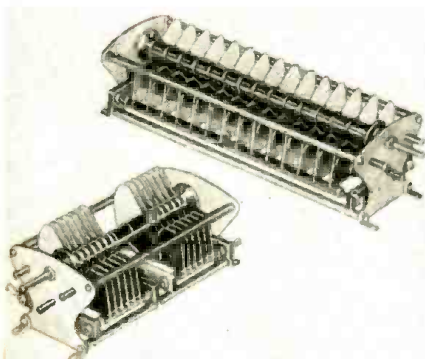

Two of the latest amateur type transmitting condensers, No. 638.

Names and addresses of manufacturers of apparatus furnished upon receipt of postcard request; mention No. of article.

The flat surfaces are also highly polished, the general construction of the frame results in an extremely rigid and neat appearing unit. The single type are available in capacities ranging from 40 mmf. to 340 mmf. with working voltages ranging from 4,000 to 11,000.

The split-stator condensers have capacity ranges from 50 to 250 mmf. with various spacings and in voltage ranges from 2,000 to 9,000 per section. In all cases the insulating material used is Micalax, which provides extremely low losses at the high and ultra high frequencies.

This article has been prepared from data supplied by courtesy of Bud Radio, Inc.

## The New T-20

(20 Watts Plate Dissipation)

● A general-purpose triode, offering outstanding value to the amateurs, the T-20 will soon establish itself as an extremely fine amplifier on all frequencies up to and including 56 mc. It is efficient as a doubler or buffer and gives real power output in Class B audio work.

### GENERAL CHARACTERISTICS

Filament Voltage, volts	7.50
Filament Current, amps	1.75
Plate Resistance, ohms	8000
Mutual Conductance, $\mu$ Mhos	2500
Amplification Factor	20



Left—New half-wave mercury vapor rectifier, type 866 Jr. Right—Recently developed general-purpose triode for frequencies as high as 56 mc. No. 639.

### PHYSICAL CHARACTERISTICS

Max. Length, inches	6 1/2
Max. Diameter, inches	2 1/2
UX Ceramic Base	

### INTER-ELECTRODE CAPACITIES

Plate to Grid, mmf.	4
CLASS "C" OSC AND POWER AMP.	

Max. Plate Volts	750
Modulated D.C. Volts	750
Max. D.C. Plate Current, mls.	75
Max. D.C. Grid Current, mls.	25
Max. Plate Dissipation, watts	20
Max. R.F. Grid Current, amps.	2.5
R.F. Output, watts	42
Percentage of Efficiency	75%

### NORMAL OPERATION

$E_p=750$	$E_G=-100$	$E_f=7.5$
-----------	------------	-----------

### CLASS "B" A.F. MODULATOR

Push-Pull Operation

### TYPICAL OPERATING COND.

Filament, volts	7.5	7.5
D.C. Plate Voltage	800	600
Grid Voltage Approx.	-40	-30
Load Resistance P-P	12,000	8100
Average D. C. Plate Current		
per tube	68	70
Static Plate Current	10	10
Power Output, Watts (2 tubes)	70	50

(Continued on page 265)

## Aerodynamic Microphone

● An Aerodynamic microphone which combines extreme compactness, excellent fidelity and novel streamlined appearance at low cost has been introduced by the RCA Commercial Sound Section.



Of the increasingly popular pressure-operated type, the RCA Aerodynamic microphone was designed to fit a wide variety of public address and "close talking" applications. It has a frequency range of from 100 to 6000 cycles. Impervious to temperature, humidity and barometric pressure changes, of a rugged construction which makes it insensitive to mechanical vibration, the new microphone is particularly suitable for outdoor use too. Amateur radio operators will also find it exceptionally adaptable to their needs.

The aerodynamic microphone is actually small enough to fit into the hand and weighs only a pound and a half. It measures 2 1/2" wide, 3" high and 3 3/4" deep. Its graceful shaped casing of polished chrome metal fits easily to desk or floor type of stands. External excitation or power are unnecessary. It operates at an impedance of 250 ohms and is completely shielded against r-f or a-c fields.

This article has been prepared from data supplied by courtesy of RCA Mfg. Co.

## High-Voltage Neutralizing Condensers

● THE neutralizing condensers shown in the photo are designed to be used with the new high efficiency triodes operating at high voltages and frequencies. One is for neutralizing the smaller tubes such as the 35-T, T-55, RK-37, 808 and other similar tubes. This condenser has two adjustable plates mounted 1 1/2 inches high with a diameter of 1-27/32 inches and a thickness of 1/16 inch. The larger condensers have a 3-inch mounting with 1/4 inch thick plates and a diameter of 2 1/8 inches; these are for neutralizing the high-power tubes such as the 150-T, HK-354, HF-300, RK-37, 806 and other tubes having similar capacities and voltage ratings.

This article has been prepared from data supplied by courtesy of Bud Radio, Inc.

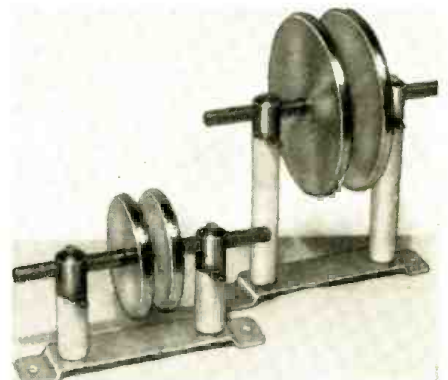

New neutralizing condensers for use at high voltages and frequencies. The plates are very substantial and will hold their adjustment. No. 640.



↓ S.W. BROADCAST BAND ↓

Mc.	Call	Mc.	Call
6.160	YV6RD	CARACAS, VENEZUELA, 48.7 m. 11 am.-2 pm., 4-10.40 pm.	
6.160	VUZ	COLOMBO, CEYLON, 48.7 m. Daily exc. Thurs. and Fri., 7 im.-12.30 pm.; Sun. 7-11.30 am.	
6.160	CSL	LISBON, PORTUGAL, 48.78 m. Irregular. 7-8.30 am., 2-7 pm.	
6.160	CJRO	WINNIPEG, MAN., CANADA, 48.78 m., Addr. (See 11.720 mc.) 4-10 pm.	
6.147	ZEB	BULAWAYO, RHODESIA, S. AFRICA, 48.8 m. Sun. 3.30-5 am.; Tues., Fri., 1.15-3.15 pm.; Mon. and Thurs. 11 am.-12 m.	
6.147	COKO	SANTIAGO, CUBA, 48.8 m., Addr. Box 137. 9-10 am., 11.30 am.-1.30 pm., 3-4.30 pm., 10-11 pm., 12 m.-2 am.	
6.146	HJ4ABU	PEREIRA, COL., 48.8 m. 9.30 am.-12 m., 6.30-10 pm.	
6.140	W8XK	PITTSBURGH, PA., 48.86 m., Addr. Westinghouse Electric & Mfg. Co. Relays KDKA 9 pm.-12 m.	
6.137	CR7AA	LAURENCO MARQUES, PORT. E. 48.87 m. 4-9, 10.30-11 am., 12 m.-3.30 pm., 11.15 pm.-1 am.	
6.135	HJ1ABB	BARRANQUILLA, COL., 48.9 m., Addr. P. O. Box 715. 11.30 am.-1 pm., 4.30-10 pm.	
6.135	HI5N	SANTIAGO, D. R., 48.9 m. 6.40-9.10 pm	
6.130	TGXA	GUATEMALA CITY, GUAT., 48.94 m., Addr. Giornal Liberal Progressista. Irregularly.	
6.130	COCQ	HAVANA, CUBA, 48.94 m., Addr. Calle G y 25, Vedado. Relays CMCD 11 am.-12 m., 7-10 pm.; Sun. 12m.-4 pm.	
6.130	VE3HX	HALIFAX, N. S., CAN., 48.94 m., Addr. P. O. Box 998. Mon.-Fri. 9 am.-1 pm., 5-11 pm. Fri.; 1-3 pm., Sat.; Sun. 9 am.-1 pm., 2-11 pm. Relays CHNS.	
6.130	ZGE	KUALA LUMPUR, FED. MALAY ST., 48.94 m. Sun., Tue. and Fri. 6.40-8.40 am.	
6.130	LKL	JELOY, NORWAY, 48.94 m. 11 am.-6 pm.	
6.125	CXA4	MONTEVIDEO, URUGUAY, 48.98 m., Addr. Radio Electrico de Montevideo., Mercedes 823. 10 am.-12 m., 2-8 pm.	
6.125	OAX1A	CHICLAYO, PERU, 48.98 m., Addr. La Voz de Chivlayo, Casilla No. 9. 8-11 pm.	
6.122	OAX4P	HUANCAYO, PERU, 49 m. La Voz del Centro del Peru. 8 pm. on.	
6.122	HP5A	PANAMA CITY, PAN., 49 m. Addr. Box 58. 12 n-1 pm., 8-10 pm.	
6.122	HJ3ABX	BOGOTA, COL., 49 m., Addr. La Voz de Col., Apartado 2665. 12 n.-2 pm., 5.30-11 pm.; Sun. 6-11 pm.	
6.120	W2XE	NEW YORK CITY, 49.02 m., Addr. Col. B'cast. System. 485 Madison Ave. Irregular.	
6.120	XEUZ	MEXICO CITY, MEX., 49.02 m., Addr. 5 de Mayo 21. Relays XEFO 1-3 am.	
6.116	OLR2C	PRAGUE, CZECHOSLOVAKIA, 49.05 m. (See 11.875 mc.)	
6.110	XEPW	MEXICO CITY, MEX., 49.1 m., Addr. La Voz de Aguila Azteca desde Mex., Apartado 8403. Relays XEJW 11 pm.-1 am.	
6.110	VUC	CALCUTTA, INDIA, 49.1 m. Daily 3-5.30 am., 9.30 am.-12 m.; Sun 7.30 am.-12 m.	
6.106	HJ4ABB	MANIZALES, COL., 49.14 m., Addr. P. O. Box 175. Mon.-Fri 12.15-1 pm.; Tue. and Fri. 7.30-10 pm.; Sun 2.30-5 pm.	
6.100	W3XAL	BOUND BROOK, N. J., 49.18 m., Addr. Natl. Broad. Co. 7-10 pm.	
6.100	W9XF	CHICAGO, ILL., 49.18 m., Addr. N.B.C. 10.30 pm.-1 am.	
6.100	HJ4ABE	MEDELLIN, COL., 49.18 m. 11 am.-12 m., 8-10.30 pm.	
6.097	ZTJ	JOHANNESBURG, S. AFRICA, 49.2 m., Addr. African Broad. Co. Sun.-Fri. 11.45 pm.-12.30 am.; Mon.-Sat. 3.30-7 am., 9 am.-4 pm.; Sun, 8-10.15 am., 12.30-3 pm.	

Mc.	Call	Mc.	Call
6.096	JZH	TOKIO, JAPAN, 49.22 m., Addr. (See 11.800 mc., JZJ.) Irregular.	
6.092	OAX4Z	LIMA, PERU 49.25 m. Radio National 7-11 pm.	
6.090	HJ4ABC	IBAGUE, COL., 49.26 m. 7 pm.-12 m.	
6.090	CRCX	TORONTO, CAN., 49.26 m., Addr. Can. Broadcasting Corp. Daily 5.30-11.30 pm.; Sun. 5-11.30 pm.	
6.090	ZBW2	HONGKONG, CHINA, 49.26 m., Addr. P. O. Box 200. Irregular.	
6.085	HJ5ABD	CALI, COLOMBIA, 49.3 m., Addr. La Voz de Valle. 12m.-1.30 pm., 5.10-9.40 pm.	
6.083	VQ7LO	NAIROBI, KENYA, AFRICA, 49.31 m., Addr. Cable and Wireless. Ltd. Mon.-Fri. 5.45-6.15 am., 11.30 am.-2.30 pm., also Tues. and Thurs. 8.30-9.30 am.; Sat. 11.30 am.-3.30 pm.; Sun. 11 am.-2 pm.	
6.080	ZHJ	PENANG, FED. MALAY STATES, 49.34 m. 6.40-8.40 am., except Sun., also Sat. 11 pm.-1 am.	
6.080	CP5	LAPAZ, BOLIVA, 49.34 m. 7-10.30 pm.	
6.080	HP5F	COLON, PAN., 49.34 m., Addr. Carlton Hotel. 11.45am.-1.15 pm., 7.45-10 pm.	
6.080	W9XAA	CHICAGO, ILL., 49.34 m., Addr. Chicago Fed. of Labor. Relays WCFL Irregular	
6.079	DJM	BERLIN, GERMANY, 49.34 m., Addr. Broadcasting House. Irregular.	
6.070	HJ3ABF	BOGOTA, COL., 49.42 m. 7-11.15 pm.	
6.070	CFRX	TORONTO, CAN., 49.42 m. Relays CFRB 6.30 am-11 pm. Sun. 9.30 am.-11 p. m.	
6.070	YV1RE	MARACAIBO, VEN., 49.42 m. 6-11 pm.	
6.070	VE9CS	VANCOUVER, B. C., CAN., 49.42 m. Sun. 1.45-9 pm., 10.30 pm.-1am.; Tues. 6-7.30 pm., 11.30 pm.-1.30 am. Daily 6-7.30 pm.	
6.065	HJ4ABL	MANIZALES, COL., 49.46 m. Daily 11 am.-12 m., 5.30-7.30 pm.; Sat. 5.30-10.30 pm.	
6.065	SBG	MOTALA, SWEDEN, 49.46 m. Relays Stockholm 1.30-6 pm.	
6.060	W8XAL	CINCINNATI, OHIO, 49.6 m., Addr. Crosley Radio Corp. Relays WLW 5.30 am.-7 pm., 10 pm.-1 am.	
6.060	W3XAU	PHILADELPHIA, PA., 49.5 m. Relays WCAU 7-10 pm.	
6.060	OXY	SKAMLEBOAEK, DENMARK, 49.5 m. 1-6.30 pm.	
6.050	HJ3ABD	BOGOTA, COL., 49.59 m., Addr. La Nueva Granada, Box 509. 12m.-2 pm., 7-11 pm.; Sun. 5-9 pm.	
6.045	HI9B	SANTIAGO, D. R., 49.63 m. Irregular 6-11 pm.	
6.042	HJ1ABG	BARRANQUILLA, COL., 49.65 m., Addr. Emisora Atlantico. 11 am.-11 pm.; Sun. 11 am.-8 pm.	
6.040	W4XB	MIAMI BEACH, FLA., 49.65 m. Relays WIOD 12m.-2 pm., 5.30-6 pm., 10 pm.-12 m.	
6.040	W1XAL	BOSTON, MASS., 49.65 m., Addr. University Club. Generally from 6-10 pm.	
6.040	YDA	TANDJONGPRIOK, JAVA, 49.65 m., Addr. N.I.R.O.M., Batavia. 10.30 pm.-2 am.; Sat. 7.30 pm.-2 am.	
6.030	HJ4ABP	MEDELLIN, COL., 49.75 m. 8-11 pm.	
6.030	HP5B	PANAMA CITY, PAN., 49.75 m., Addr. P.O. Box 910. 12m.-1 pm., 7-10.30 pm.	
6.030	VE9CA	CALGARY, ALTA., CAN., 49.75 m. Thur. 9 am.-2 am.; Sun 12 m.-12 m.	
6.030	OLR2B	PRAGUE, CZECHOSLOVAKIA, 49.75 m. (See 11.875 mc.)	
6.025	HJ1ABJ	SANTA MARTA, COL., 49.79 m. 5.30-10.30 pm. except Wed.	
6.020	DJC	BERLIN, GERMANY, 49.83 m., Addr. (See 6.079 mc.) 11.35 am.-4.30 pm.	
6.020	XEUW	VERA CRUZ, MEX., 49.83 m., Addr. Av. Independencia 98. 8 pm.-12.30 am.	
6.018	ZHI	SINGAPORE, MALAYA, 49.18 m., Addr. Radio Service Co., 20 Orchard Rd. Mon., Wed. and Thur. 5.40-8.0 am.; Sat. 10.40 pm.-1.10 am.	
6.015	H13U	SANTIAGO DE LOS CABALLEROS, D. R., 49.88 m. 7.30-9 am., 12m.-2 pm., 5-7 pm., 8-9.30 pm.; Sun. 12.30-2, 5-6 pm.	

Mc.	Call	Mc.	Call
6.012	HJ5ABH	BOGOTA, COL., 49.91 m., Addr. Apartado 565. 12 n.-2 pm., 6-11 pm.; Sun. 12m.-2 pm., 4-11 pm.	
6.010	VP3MR	GEORGETOWN, BRI. GUIANA, 49.9 m. Sun. 7.45-10.15 am.; Daily 4.45-8.45 pm.	
6.010	COCO	HAVANA, CUBA, 49.92 m., Addr. P. O. Box 98. Daily 9.30 am.-1 pm., 4-7 pm., 8-10 pm.; Sat. also 11.30 pm.-2 am.	
6.005	HP5K	COLON, PAN., 49.96 m., Addr. Box 33. 7.30-9 am., 12m.-1 pm., 6-9 pm.	
6.005	CFCX	MONTREAL, CAN., 49.96 m., Can. Marconi Co. Relays CFCF 6 am.-11.15 pm.; Sun. 9 am.-11.15 pm.	
6.005	VE9DN	DRUMMONDVILLE, QUE., CAN., 49.96 m., Addr. Canadian Marconi Co. Sat. 11.30 pm.-2 am.	
6.000	ZEA	SALISBURY, RHODESIA, S. AFRICA, 50 m. (See 6.147 mc., ZEB.)	
6.000	RV5B	MOSCOW, U.S.S.R., 50 m. Irregular.	
6.990	XEBT	MEXICO CITY, MEX., 50.08 m., Addr. P. O. Box 79-44. 8 am.-1 am.	

↑ S.W. BROADCAST BAND ↑

Mc.	Call	Mc.	Call
6.970	HJ4ABD	MEDELLIN, COL., 50.26 m., Addr. La Voz Catia. 8-11.30 pm.	
6.968	HVJ	VATICAN CITY, 50.27 m. 2-2.15 pm. daily; Sun. 5-5.30 am.	
6.950	HJN	BOGOTA, COL., Radiodifusora Nacional, 50.42 m. 6-11 pm.	
6.940	TG2X	GUATEMALA CITY, GUAT., 50.5 m. 4-6, 9-11 pm.; Sun. 2-5 am.	
6.930	YV1RL	MARACAIBO, VEN., 50.59 m., Addr. Radio Popular, Jose A. Higuera M., P. O. Box 247. Daily 11.43 am.-1.43 pm., 5.13-10.13 pm.; Sun. 9.13 am.-3.13 pm.	
6.925	HH2S	PORT-AU-PRINCE, HAYTI, 50.63 m., Addr. P. O. Box A103. 7-9.45 pm.	
6.917	YV4RP	VALENCIA, VEN., 50.71 m. Irregular.	
6.900	TIMS	PUNTARENAS, COSTA RICA, 50.85 m. 6-10 pm.	
6.898	YV3RA	BARQUISIMETO, VEN., 50.86 m., Addr. La Voz de Lara, 12 m.-1 pm., 6-10 pm.	
6.890	JIC	TAIHOKU, FORMOSA, 50.93 m. Works Tokio 6-9 am.	
6.885	HCK	QUITO, ECUADOR, 50.98 m. 8-11 pm.	
6.875	HRN	TEGUCIGALPA, HONDURAS, 51.06 m. 1.15-2.16, 8.30-10 pm.; Sun 3.30-5.30, 8.30-9.30 pm.	
6.855	HI1J	SAN PEDRO DE MACORIS, D. R., 51.25 m., Addr. Box 204. 12 m.-2 pm., 6.30-9 pm.	
6.853	WOB	LAWRENCEVILLE, N. J., 51.26 m., Addr. A. T. & T. Co. Works Bermuda nights.	
6.850	YV1RB	MARACAIBO, VEN., 51.28 m., Addr. Apartado 214. 8.45-9.45 am., 11.15 am.-12.15 pm., 4.45-9.45 pm.; Sun. 11.45 am.-12.45 pm.	
6.830	TDD	SHINKYO, MANCHUKUO, 51.46 m. Works Tokio 6-9 am.	
6.830	TIGPH	SAN JOSE, COSTA RICA, 51.5 m., Addr. Alma Tica, Apartado 800. 11 am.-1 pm., 6-10 pm. Relays TIX 9-10 pm.	
6.800	YV5RC	CARACAS, VEN., 51.72 m., Addr. Radio Caracas. Sun. 8.30am.-10.30 pm. Daily 7-8 am., 10.45 am.-1.30 pm., 4-9.30 pm.	
6.790	JVU	NAZAKI, JAPAN, 51.81 m. Irregular.	
6.780	OAX4D	LIMA, PERU, 51.9 m., Addr. P. O. Box 853. Mon., Wed. and Sat. 9-11.30 pm.	
6.758	YNOP	MANAGUA, NICARAGUA, 52.11 m. 8-9.30 pm.	
6.740	TGS	GUATEMALA CITY, GUAT., 52.26 m. Wed., Thur. and Sun. 6-9 pm.	
6.730	HCI1PM	QUITO, ECUADOR, 52.36 m. Irregular 10 pm.-12 m.	
6.720	YV2RB	SAN CRISTOBAL, VEN., 52.45 m., Addr. La Voz de Tachira. 6-11.30 pm.	
6.500	T15HH	SAN RAMON, COSTA RICA, 54.55 m. Irregular 3.30-4, 8-11.30 pm.	
6.145	PMY	BANDOENG, JAVA, 58.31 m. 5.30-11 am.	
6.077	WCN	LAWRENCEVILLE, N. J., 59.08 m. Addr. A. T. & T. Co. Works England late at night irregularly.	
6.025	ZFA	HAMILTON, BERMUDA, 59.7 m. Works N. Y. C. irregularly at night.	

(Continued on page 252)



\$5.00 PRIZE

5-METER ANTENNA CONNECTOR

Obtain two brass couplings of the type used for connecting variable condenser rotors together, cut both in two with a hand-saw...

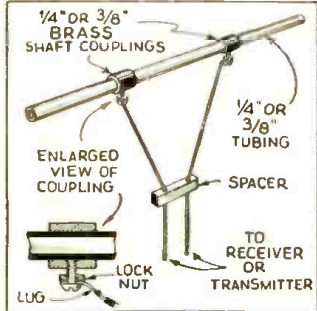

loosening the bolts. 5/8 inch tubing and couplings work better as they are more sturdy. Consult the drawing for details.—Gordon Mastallo.

SIMPLE HALF-WAVE RECTIFIER

I am submitting a simple half-wave rectifier which I find quite useful for experimental work. The following description will explain it.

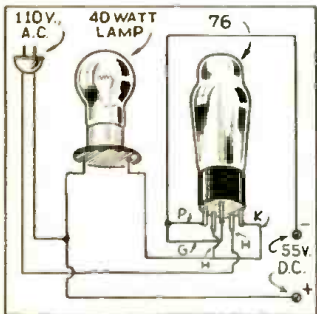

\$5.00 FOR BEST SHORT-WAVE KINK

The Editor will award a five dollar prize each month for the best short-wave kink submitted by our readers. All other kinks accepted and published will be awarded eight months' subscription to SHORT WAVE & TELEVISION.

voltage and current flow.—M. F. Fleischman.

IRON HEAT CONTROLLED BY HOLDER

Here is a simple soldering iron rest that not only holds the iron safely, but automatically cuts in the resistance of a lamp when the iron is laid on it.

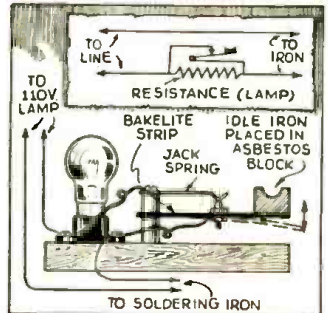

switch closed until the iron is placed on the rest.—W. T. D. Murray.

RELAY FROM GENERATOR CUT-OUT

To make a relay from a generator "cut-out," remove the original windings and re-wind with about No. 22 magnet wire.

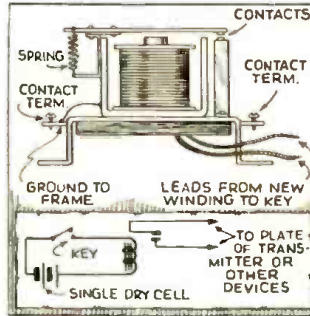

A GREAT IDEA FOR SOLDER

I am sure that the following idea will be found useful by amateurs, experimenters and servicemen. You proceed by obtaining a 1/4-inch rod or lead pencil and winding the wire solder to whatever length you want the handle.

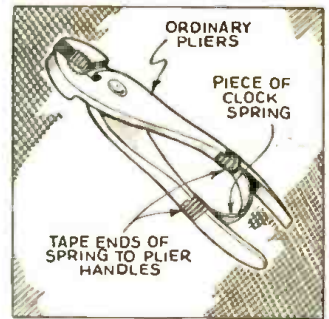
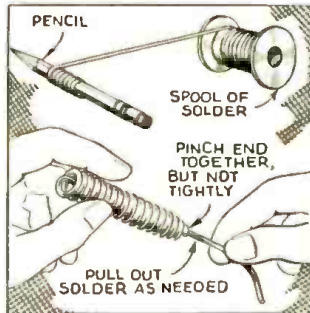

AUTOMATIC PLIER OPENER

Here is my pet time and temper saver. The automatic plier opener is simply an old piece of clock-spring taped in place as shown.

INSULATING PAINT

I have not seen this Kink in print before so I pass it on to the "Ham" fraternity. Obtain a black (or brown, if brown paint is desired) phonograph record and remove all the paper.

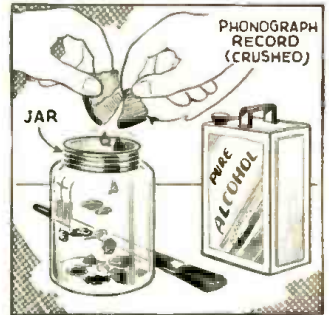

HELP!

Come on boys, step on it, we need good Kinks and let us have original ones! No duplicates or "lifts" from other magazines!

New U.H.F. Tube

ESPECIALLY designed for use in ultra high frequency or short wave service, a new oscillator and amplifier tube has been announced by a leading radio tube manufacturer.

obtained at the shorter wave lengths than has heretofore been conveniently possible. It can be used equally well in ultra high frequency radio transmitters, wherever a three element radio frequency amplifying tube of its characteristics is required.

The usual types of tube construction have been modified in this distinctly modern power tube by supporting the grid, filament and plate electrodes directly from short heavy rods.

terminate in short sturdy thimbles which may be used to connect directly with the external circuits. This tube is one of the first on which such basing has been used, although it has been used for many years on high wattage airport flood lamps where the high current carrying ability has been conclusively demonstrated.

Other decided advantages are the low inter-electrode capacity of the tube which results from the new mounting and the high conductivity of the large and short support rods. Tantalum is utilized for the anode material in this tube which from previous experience has proven superior for tubes designed for high frequency operation.

The simplification of the internal supporting structure has also made it possible to reduce the size of the tube to the point where only a minimum amount of space need be reserved for it. Designated as the WL-461, this tube has the following ratings:—maximum d.c. plate voltage—2000 volts; maximum a.c. plate voltage—2500 volts; and maximum plate current—250 ma.

Our information bureau will gladly supply manufacturer's names and addresses of

Water-Cooled Tube

any items mentioned in Short Wave & Television. Please enclose a stamped return envelope.

TWO new RCA Water-Cooled Transmitting Triodes have been designed to give high power output at ultra-high frequencies, the RCA-887 and RCA-888.

Alike in fundamental design, the 887 and 888 feature no internal insulating material, low inter-electrode capacitances, low lead inductance, attached water-jacket, and high out-put capability.

When used as oscillators, these new tubes can be operated with the maximum power input of 1200 watts at frequencies as high as 240 megacycles (wavelengths down to 1.25 meters). In r-f amplifier service with its inherently higher efficiency at the

(Continued on page 270)

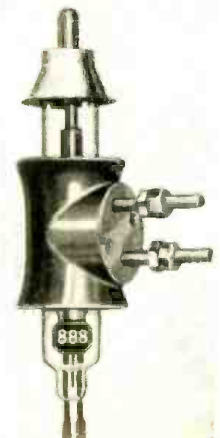

Names and addresses of manufacturers of apparatus furnished upon receipt of postcard request; mention No. of article.



# SHORT WAVE LEAGUE



## HONORARY MEMBERS

- Dr. Lee de Forest
  - John L. Reinartz
  - D. E. Replogle
  - Hollis Baird
  - E. T. Somerset
  - Baron Manfred von Ardenne
  - Hugo Gernsback
- Executive Secretary*

## Here's Your Button

The illustration herewith shows the beautiful design of the "Official" Short Wave League button, which is available to everyone who becomes a member of the Short Wave League.



The requirements for joining the League are explained in a booklet, copies of which will be mailed upon request. The button measures 3/4 inch in diameter and is inlaid in enamel—3 colors—red, white, and blue.

Please note that you can order your button AT ONCE—SHORT WAVE LEAGUE supplies it at cost, the price, including the mailing, being 35 cents. A solid gold button is furnished for \$2.00 prepaid. Address all communications to SHORT WAVE LEAGUE, 99-101 Hudson St., New York.

## WHEN TO LISTEN IN

by M. Harvey Gernsback

(All Schedules in Eastern Standard Time)

### WEST INDIES

● WE are informed that PJCI at Curacao, N.W.I., will broadcast a special Dixer's program on August 27th from 7:36 to 8:36 p.m. A special verification card will be issued to all sending reports together with an *International Reply Postal Coupon*. Address reports to: Johan P. Curiel, Mundo Nobo No. 143, Curacao, N.W.I. PJCI operates on 5.93 mc.

### HOLLAND

PHI is on a new schedule as follows: Sun., 7:25-10:35 a.m.; Sat., 8:25-10:40 a.m.; Daily except Wed., 8:25-10:00 a.m. PCJ continues on its old schedule.

### LONG ISLAND

W2XGB at Hicksville, N.Y., operated by Press Wireless tests irregularly on 18.56, 17.31, 12.86 and 6.425 mc., according to Thomas Twist of Norfolk, Va.

### BOUND BROOK

W3XAL at Bound Brook, N.J., operates daily from 8 a.m. to 8 p.m. on 17.78 mc. A South American beam antenna is employed from 2-8 p.m. Special programs in Spanish and Portuguese are broadcast daily except Sun. from 7-7:30 p.m. On Wed., Thurs., and Fri. from 7-8 p.m.

### VERIS

The Quixote Radio Club, Box 772, Santa Barbara, Cal., advises that all requests for verifications from stations HRN, Tegucigalpa; HI9B, Santiago de los Caballeros, D.R.; XEDQ, Guadalajara, Mex.; XEBM, Mazatlan, Mex.; and HJ3ABX, Bogota, Col., may be addressed to them together with a dime and three cents postage. Periodically they will forward them by air mail to the stations together with the dimes. The stations will in turn mail veris directly to the listeners. The club guarantees that the stations will issue the veris as they have made special arrangements with them.

### CZECHOSLOVAKIA

OLR at Prague now broadcasts for America on Mon. and Thur. from 7-9 p.m. on either OLR4A, 11.84 mc. or OLR5A, 15.23 mc. A further test program is usually given on these nights from 9-10 p.m. on OLR5A. The station is also on daily from 2:30 to 4:30 p.m. with a program for Europe on either OLR4A, OLR5A or OLR5C, 15.16 mc.

### ROME

All of the programs of 2RO are now broadcast on 11.81 mc. for the summer months.

### NEW YORK

Due to an error we stated last month that W2XE now uses 40 kw. Actually the station operates with 10 kw. power on the following schedule 6:30-9 a.m. on 21.52 mc., 2-5 p.m. on 15.27 mc., 6-11 p.m. on 11.83 mc. The station employs a European beam antenna until 7 p.m. when a shift is made to a South American beam. Special programs for European and South American audiences are presented as well as relays of the WABC programs.

### MEXICO

A new unidentified Mexican on 15.165 mc. is heard with good strength and excellent quality daily from early morning till 6 p.m. It apparently relays a long wave station. A 3-note chime is used as signal. No English announcements have been heard. At times it is badly heterodyned by another "unknown" on about 15.162 mc.

### News Broadcasts from South America

Inauguration of two new series of *Press Radio News* broadcasts to South America over short-wave station W3XAL, Bound Brook, N.J., was announced recently by the National Broadcasting Company at its headquarters in Radio City, New York. Both series are heard daily, except on Sundays.

One of the series, directed especially to Brazil, is broadcast from 7:15 to 7:30 p.m., EDST. Press Radio News reports are given in Portuguese by Pinto Tameirao, Brazilian, who was recently added to the announcing staff of the NBC South American Program Department. The six broadcasts will add an hour and a half to

NBC's weekly schedule of South American programs, making a new total of nine hours and fifteen minutes.

The other new series, which replaces a routine news broadcast, will be heard from 7:00 to 7:15 p.m., EDST, and will be directed to Argentina. Martin Viale, from the Argentine, also an addition to the announcing staff, will present the Press Radio News in Spanish.

### New Zealander Heard "Coronation" Over W2XAF

Ian K. Henderson of Wellington, New Zealand, expresses his thanks to General Electric, saying that "if it was not for the fact that W2XAF relayed the proceedings on short waves, listeners out here would have had to do without the last part of the broadcast. The local station which was rebroadcasting from Daventry, England, was only audible about 15 min. and then faded out."

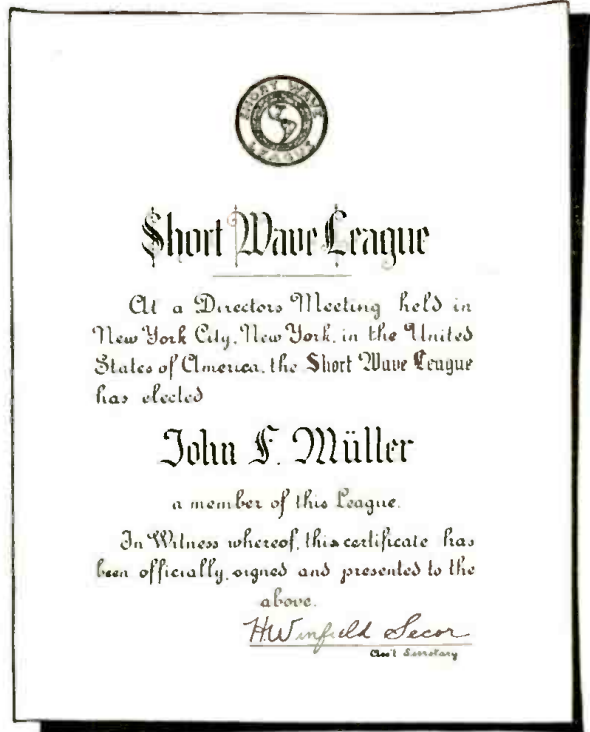

This is the handsome certificate that is presented FREE to all members of the SHORT WAVE LEAGUE. The full size is 7 1/4 "x9 1/2 ".

See page 592 how to obtain certificate.



# SHORT WAVE EDITED BY G. W. SHUART, W2AMN

# QUESTION BOX

● Because the amount of work involved in the drawing of diagrams and the compilation of data, we are forced to charge 25c each for letters that are answered directly through the mail. This fee includes only hand-drawn schematic drawings. We cannot furnish "picture-layouts"

or "full-sized" working drawings. Letters not accompanied by 25c will be answered in turn on this page. The 25c remittance may be made in the form of stamps, coin or money order. Special problems involving considerable research will be quoted upon request. We cannot

offer opinions as to the relative merits of commercial instruments. Correspondents are requested to write or print their names and addresses clearly. Hundreds of letters remain unanswered because of incomplete or illegible addresses.

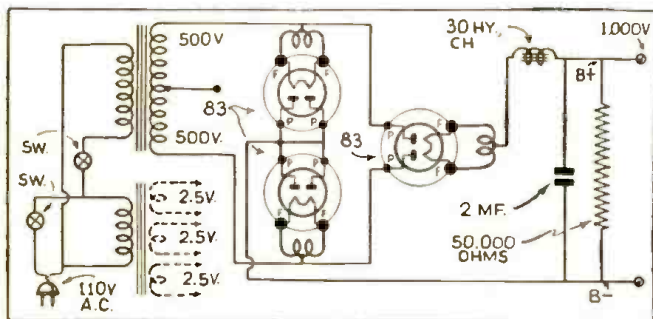

High Voltage Bridge Rectifier—1082

### BRIDGE RECTIFIER

Alvin Nichols, Pawtucket, R. I.  
(Q.) I have a power-supply which, at the present time delivers 500 volts. The transformer used is a center-tap affair and has 500 volts each side of the center-tap. I would like to use a bridge rectifier arrangement whereby I could obtain 1,000 volts from the same transformer. Will you please print the necessary diagram in the Question Box?

(A.) We have shown the diagram of a power-supply employing three type 83 rectifiers. The filament transformer must have three separate 2.5 volt windings. If your transformer is rated at 500 volts at 250 ma. with a full-wave rectifier system, the output of the new system will then be rated at 1,000 volts at approximately 125 ma.

### "PUSH-PULL" BEAM-TUBE TRANSMITTER

Roger Parsons, Massillon, Ohio.  
(Q.) I would like to build a simple crystal control transmitter using two beam tubes. Would you be kind enough to show the diagram of such a transmitter.

(A.) If only one-band operation is desired with a single crystal, the most efficient arrangement would be one employing two tubes in push-pull. It should be comparatively easy to obtain 40 or 50 watts from such a transmitter. In some cases there may be a tendency toward high-frequency parasitic oscillation and therefore we recommend a 6 or 8 turn coil be placed in series with one of the plate leads. While this coil will not affect the circuit appreciably, it will in a majority of cases eliminate all tendencies toward ultra high frequency oscillation.

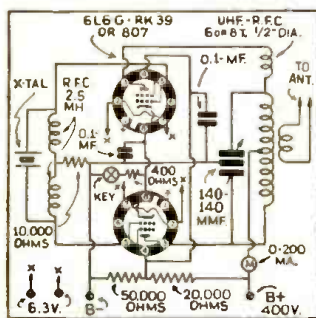

Simple Transmitter—1083

### PORTABLE 5-METER RECEIVER

Kenneth Richfield, Olympia, Wash.  
(Q.) I would like to build a portable 5-meter receiver using 2 tubes, something that will give fairly good results and still not be too complicated. I would like to use a 1A6 and a 1F4. Kindly print the diagram showing the values of parts.

(A.) We have shown the diagram of the simple super-regener-

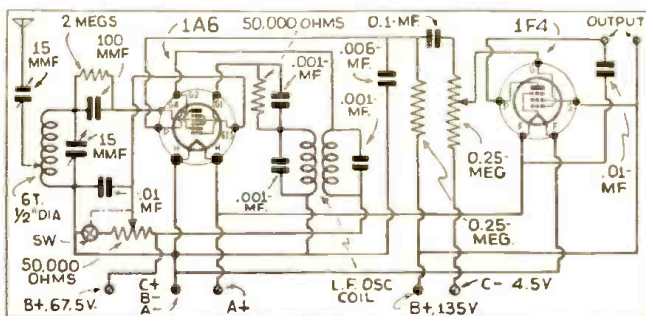

Ultra Short-Wave Receiver—1084

ator, employing an 1A6 combination high frequency oscillator. The output of this arrangement should be sufficient to operate a small speaker, if one is desired. For earphone operation a volume control must be employed. This has been shown in the diagram. Some juggling of the grid coil may be necessary in order to place the tuning range of the receiver in the 5-meter band; this can be accomplished by merely compressing or spreading the turns.

### SMALL SPACE ANTENNA

Paul Edson, Los Angeles, Calif.  
(Q.) I would like to build an efficient transmitting antenna. However, on the 80-40-20 meter bands I find that I do not have space for a good antenna. I have tried many varieties but do not seem to get out well on 80 with them. Will you kindly help us with this problem.

(A.) The solution of your problem is a simple one, providing you have at least 65 to 70 ft. of space available for an antenna. If you will refer to the August 1936 issue, page 211, you will find described an antenna system which works out very well. It is a 40 meter half-wave doublet with "spaced" tuned feeders. Experience had proven that it works exceptionally well on 80 meters and, of course, on 40 it is a conventional half-wave doublet and on 20 meters it operates as two half waves in phase.

### TUNING TRANSMITTER

R. Johnson, New York City, N. Y.  
(Q.) Would you kindly explain the procedure for tuning a crystal-controlled MOPA transmitter, including neutralization; some simple method which can be easily followed and is sure to work out properly.

(A.) Assuming a transmitter to have a 47 pentode crystal-controlled oscillator and a 210 amplifier, the proper procedure would be (with the filaments already heated) to apply plate voltage to the oscillator only. Rotate the oscillator tuning dial until a dip occurs in the plate current. The condenser should be set slightly toward the low capacity side of this dip, we assume here also that grid-leak bias is employed in the 47 circuit. The next procedure is to measure the grid current in the final amplifier, without the plate voltage applied, but with the keying circuits closed. If capacity coupling is employed between the output of the oscillator and the grid of the amplifier, the grid current would be already indicated by the meter, however, if link coupling is employed then the amplifier grid condenser should be adjusted for maximum grid current. If at this point the oscillator plate current rises too high or the oscillator

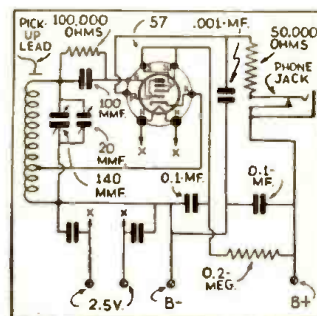

Monitor—1085

### MONITOR FREQUENCY METER

Richard Atkins, Capetown, So. Africa.

(Q.) I am completing new equipment for the transmitting station and would like to have a diagram of the most efficient yet simple combination frequency meter and monitor.

(A.) We find the diagram a 57 electron-coupled oscillator. The size of the coils will depend upon the particular band on which it is to operate. This instrument should be built in an entirely shielded cabinet or box and the power-supply leads should also be shielded in order to prevent too much pick-up. If external pick-up is needed a short piece of wire is used and one end should be placed reasonably close to the grid lead on the coil and the other end extending outside the shielded box for a distance of several inches.

### 3-TUBE RECEIVER

Ramon Fernandez, Havana, Cuba

(Q.) I have several older type tubes around which I would like to build a short-wave receiver. These consist of types 24 and 27. Would you kindly show a diagram of a suitable receiver employing 3 of these tubes.

(A.) The diagram you requested is shown. The circuit is entirely conventional and has been published a great many times. It consists merely of a regenerative detector with two stages of audio amplification. Resistance coupling is used between the detector and the first audio amplifier, while transformer coupling is used between the 2 audio stages. Resistance coupling may be employed here also. The grid circuit would be the same as the first stage, while the plate circuit of the first stage should have a 25,000 or 50,000 ohm resistor.

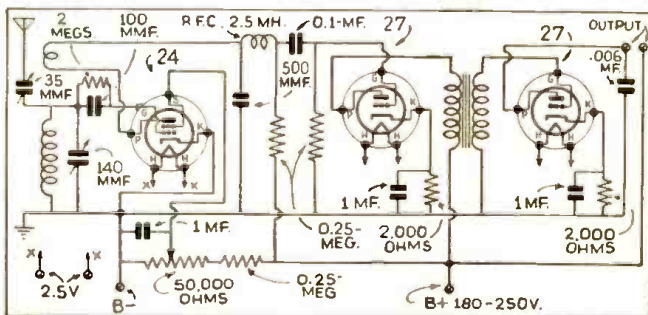

3-Tube Receiver Using Old-Style Tubes—1086



PERFECTED ELECTRIC TUNING—  
JUST TOUCH BUTTONS

AUTOMATICALLY STOPS  
"SMACK" ON THE STATION

MAGIC MOVIE  
SIX-CONTINENT  
DIAL

NO MORE DIAL TWIDDLING—  
ELECTRICALLY AUTOMATIC

9 TOUCH BUTTONS BRING IN  
9 STATIONS—IN A FLASH!

**JUST TOUCH BUTTON—  
LATEST 20-TUBE  
MIDWEST TUNES ITSELF  
BY ELECTRIC MOTOR!**

**ONLY MIDWEST'S DIRECT-FROM-FACTORY  
POLICY MAKES THIS AND OTHER SENSATIONAL  
FEATURES POSSIBLE AT AMAZINGLY LOW PRICES!**

**30 DAYS  
FREE  
TRIAL**

HERE'S today's radio sensation! No more dial twiddling—no more squinting—no more stooping when you tune a radio! Just touch an electric button (on top of radio) and its corresponding station zips in . . . and the dial **STOPS ITSELF** automatically on the station. All this happens in  $\frac{1}{8}$  second with Midwest Perfected ELECTRIC Tuning: (1) You touch button—electric motor speeds dial towards corresponding station; (2) Colorful Bull's Eye darts across dial and locates itself behind station; (3) As dial flashes to station, it "hunts" back and forth for an instant—and stops itself and winks at exact center of resonance. Zip . . . Zip . . . Zip . . . you bring in 9 perfectly tuned stations in 3 seconds!

Only \$ **49.95**

**FACTORY-TO-YOU  
NEW LOW BASE  
PRICE CHASSIS**



**20 TUBES FOR PRICE OF 10**

Why be content with an ordinary 10, 12 or 14-tube set, when you can buy a 20-tube Super Deluxe ELECTRIC TUNING Midwest for the same money! It will surprise and delight you with its brilliant world-wide reception on 6 bands. You save 50%—and get 30 days free trial in your own home—when you buy direct from the factory at wholesale prices. You are triply protected with Foreign Reception Guarantee, One-Year Warranty and Money-Back Guarantees.

**TERMS AS LOW AS \$1.00 A WEEK**

You have a whole year to pay for your Midwest on the easiest and most convenient credit terms. Never before have you been offered so much radio for so little money—and on such easy terms!

**Send for FREE 40-page Catalog!**

See for yourself that Midwest offers today's greatest radio values! Write for new 1938 Factory-To-You Catalog showing 40 pages of radios, chassis and features—in their natural colors. Select the one you like on 30 days FREE TRIAL in your own home.

**SERVICE MEN:**  
Join nation-wide Midwest service organization. Write for free details!

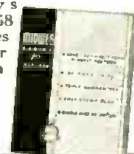

**AMAZING NEW FEATURES GIVE HUMAN PERFORMANCE**

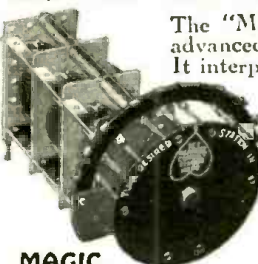

**MAGIC  
MYSTIC BRAIN**

The "Magic Mystic Brain" is just one of 101 advanced features, many of them exclusive! It interprets your touch button signals and controls the electric motor. Nine contact fingers can be easily set to any stations you desire. Even a child can do it!

**MAGIC MOVIE DIAL**

Now, you can delight in the world's finest six-continent overseas reception with a range of 12,000 and more miles (125 to 20,000 KC.) Note that chassis dial shows only broadcast band. Then flip 6-wave band switch, and, instantly, five additional bands are projected on the dial.

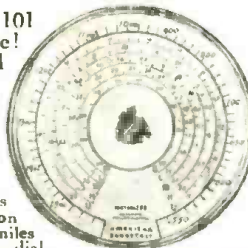

**MIDWEST  
WORLD-WIDE RADIOS**

**MIDWEST RADIO CORPORATION  
DEPT. BB-14 CINCINNATI, OHIO, U.S.A.**

**PASTE COUPON ON 1¢ POSTCARD...OR WRITE TODAY.**

**MIDWEST RADIO CORPORATION**

Dept. BB-14, Cincinnati, O.

Send me your new FREE catalog and complete details of your liberal 30-day FREE trial offer.

(Special offer and prices prevail only when dealing direct with factory by mail.)

Name \_\_\_\_\_

Address \_\_\_\_\_

Town \_\_\_\_\_ State \_\_\_\_\_

User-Agents Make Easy Extra Money. Check Here  for details  Check Here for 24-page BATTERY catalog

Please mention SHORT WAVE & TELEVISION when writing advertisers



# THE NEW 1938 SUPER SKY RIDER

5 to 550 Meters



**\$99.00** Less Speaker  
Less Crystal

- ✓ 5 to 550 Meter Coverage
- ✓ 6 Bands
- ✓ 11 Tubes
- ✓ Wide Range Variable Selectivity
- ✓ 1,000 Electrical Band Spread
- ✓ "5" Meters
- ✓ Air-trimmed RQ Circuit
- ✓ Improved Crystal Filter Control

Here's a receiver that has everything! Complete coverage from 5 to 550 meters, with a 5 meter band that's "hot." A new Band Spread of over 1,000 degrees that really permits you to "spread them out." Wide range variable selectivity (razor-sharpness to true high fidelity) and an overall sensitivity of better than 1 microvolt. All this in one precision-built receiver at an exceptionally favorable price. Available on Hallicrafters Liberal Time Payments. See this outstanding new receiver today!

Stop in to see it or write for complete information.

**HARRISON RADIO CO.**  
12 West Broadway NEW YORK CITY

## CORNELL-DUBILIER TYPES 4 and 9 MICA CAPACITORS for Roxtable X'mtg. on 5 Meters



Designed with the utmost precision, these capacitors have won first ranking honors for maximum efficiency and dependability. Dxters and "Hams" have found these condensers ideal for portable work because of their compact and sturdy construction, negligible leakage, accurate and constant capacity and simple mounting. For complete information and listing see Catalog No. 137A.

**CORNELL-DUBILIER CORP.**  
SOUTH PLAINFIELD, NEW JERSEY

## A "Folded Doublet" Saves Space

(Continued from page 231)

coils. The material used for the construction of the mast which supports the antenna are reasonably low-priced and easily obtainable. The mast is made up of 15 ft. lengths of 1-inch square straight grain pine. A length of this material is used to form each of the 4 corners of the mast. cross-pieces of this same material are placed every 2 ft. as bracing in order to strengthen the mast and even the spacing, as shown in *Television and Short Wave World* (London).

The physical dimensions of the antenna allow most efficient operation on 20 meters, however, its dimensions may be changed so that efficient operation may be obtained on any particular frequency.

## Twin-Pentode Receiver

(Continued from page 223)

band-spread, it is possible to use a straight dial which has no vernier attachment. When wiring up this condenser the rotors should be grounded independent of the chassis; do not depend upon the chassis for connections in the R.F. circuit. All connections in the diagram which go to the B negative or A negative side of the circuit should be connected to one point, preferably to a lug on one of the screws holding the tube socket. This will eliminate all signs of body-capacity and will improve the stability of the receiver.

Standard Hammarlund plug-in coils are employed, and for the benefit of those who wish to construct their own coils, we refer them to the February 1937 issue of the *Question Box*.

The antenna employed with this receiver should be one preferably 75 ft. long, that is the over-all length from the receiver to the far end. However, if a long lead-in is used, it should be as much in the clear as possible, for remember this also counts as part of the antenna. For those interested in extreme DXing in a certain direction, we might offer the suggestion that they employ a long antenna, one 150 to 200 ft. long or even longer providing space is available; point this antenna right at the section of the globe from which reception is desired. This is the simplest form of directional antenna that one can erect and it has proved to be surprisingly effective.

### Parts List

#### HAMMARLUND

- 1—35 mmf. condenser, HF style
- 1—140 mmf. condenser, HF style
- 1—15 mmf. condenser, HF style
- 1—2.1 mh. R.F. choke
- 1—octal socket, isolantite
- 1—4-prong socket, isolantite
- 1—set of plug-in coils

#### CORNELL-DUBILIER

- 1—.0001 mf. mica condenser
  - 1—.0005 mf. mica condenser
  - 1—.5 mf. by-pass condenser 100 or 200 V. rating
  - 1—.1 mf. by-pass condenser 100 or 200 V. rating
  - 1—.006 mf. mica condenser
- I.R.C.**
- 1—2 meg. ½-watt resistor
  - 1—50,000 ohm potentiometer with switch
  - 1—¼ meg. ½-watt resistor
  - 1—50,000 ohm ½-watt resistor.

#### RAYTHEON

- 1—1E7G Twin-Pentode tube

#### MISCELLANEOUS

The set was constructed on a 5"x8"x2" chassis, with a 6"x8" panel. There are two dials, plain non-vernier type and one twin-binding post assembly for earphones.

- 1—20 ohm rheostat.

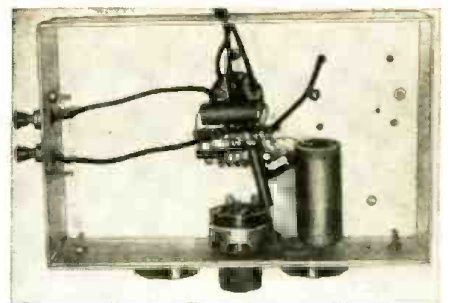

Under-side of the Twin-Pentode 1-tube receiver. The parts are few, but should be of high quality if maximum DX results are to be obtained.

*In the Next Issue!*

New 5 Meter Xmitter, by George W. Shuart, W2AMN.

*Don't Miss It!!*

Please mention SHORT WAVE & TELEVISION when writing advertisers



# NEW SHORT WAVE APPARATUS

PROMPT SHIPMENT ON ALL ITEMS



## EILEN RX19 7-Tube Bandsread Receiver

8 1/2 to 3000 Meters

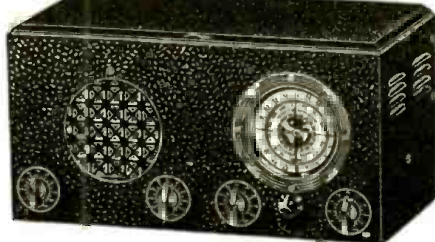

Our largest, finest, and most sensitive new 1937 receiver, unequaled in appearance, performance and value. Uses a special, highly efficient and selective circuit producing results which WILL satisfy even the most discriminating short wave fan.

ER-19 is equipped with the famous EILEN NOISE SUPPRESSOR, the latest development of our laboratories and which is skyrocketing itself into immense popularity. This remarkable development, exclusive with EILEN, enables you to enjoy reception from those far-off stations with excellent clarity and volume.

Constructed of the finest materials and to conform with the highest engineering standards, this instrument uses two 6X7s, two 6J5s, one 6D6, one 42 and one 5Y3 high gain tubes as TUNED RF AMPLIFIER, TUNED ELECTRON COUPLED SCREEN GRID REGENERATIVE DETECTOR, powerful 3 stage audio frequency amplifier with Type 42 amplifier tube output stage delivering 3 watts peak of audio power to the built-in high fidelity dynamic loudspeaker. VARIABLE NOISE SUPPRESSOR, rectifier and complete HUM-FREE power supply. BANDSPREAD TUNING—a special electron tube circuit enabling the operator to reduce or eliminate certain types of noise occurring in all short wave receivers—automatic headphone jack—smooth and noiseless controls—highly efficient interchangeable inductor—doublet or aerial-ground connections—POWERFUL high-fidelity audio system—large, illuminated airplane type vernier dial—sensitivity, volume, and selectivity that will amaze you—are features to be found in ER-19.

ER-19 in BEAUTY, as well as performance, is in a class by itself—heavy steel cabinet with blinged lid finished in durable black shrivel-colored dial lights behind black and white scale—chrome plated escutcheon—calibrated dial plates—plated chassis and shielding—Operates entirely from your 105 to 130 volts AC house current.

ER-19 under fair conditions will bring in dozens of foreign as well as domestic short wave stations with enormous volume. Order one and see for yourself.

ER-19, complete, READY TO USE, with 7 RCA or Sylvania tubes, 12 low-loss silver plated coils for 8 1/2 to 3000 meters, wired in cabinet, and instructions.....

(If metal tubes are preferred over the glass type, add \$1 to above price.)

**\$21.95**

For those who wish to build their own

**KIT of all parts, coils for 8 1/2-3000 meters, unwired (less tubes & cabinet)..... \$14.95**

Cabinet, extra..... \$2.50

7 matched Sylvania tubes, extra..... 3.35

Wired and tested, extra..... 2.00

AMATEURS: Model ER-19-B has same specifications as ER-19, except that it is equipped with plate voltage cut-off switch and special broadcast coils for 20-40-80-160 M bands spreading these bands 80% of dial scale. Add \$1 to price of ER-19. (10 meter band coils if desired extra \$1.45.)



## BS-5

### 6-Tube Band switch Receiver

10 to 600 meters



A powerful, sensitive, and selective SW receiver covering the entire wave-length span of 10 to 600 meters in 5 steps. NO PLUG-IN COILS are used. Simply turn the waveband selector switch and enjoy receipt on any wavelength within this range.

Uses two 6D6, one 76, one 43, one K42A, and one 25Z5 tubes as RF amplifier, electron coupled screen grid regenerative detector, powerful 2 stage audio amplifier with pentode output stage, rectifier, and complete built-in power supply.

HUM-FREE—High-fidelity dynamic loudspeaker—illuminate 3 airplane type vernier dial—band spread tuning control—automatic headphone jack—extremely smooth acting controls—operates from your AC or DC house current—beautiful heavy, black shrivel finish chassis and cabinet.

DELIVERS GREAT LOUDSPEAKER VOLUME ON THE GREAT MAJORITY OF SHORT WAVE FOREIGN STATIONS UNDER FAIR CONDITIONS.

PRICE, complete with 6 tubes, cabinet, wired, and instructions.

See editorial article Page 482, Dec. issue S.W.C.

**\$16.95**

BS-5 KIT, of necessary parts, including detailed instructions; less tubes, cabinet, unwired..... **\$10.95**

SPECIAL: Complete kit, cabinet, tubes and instructions, unwired..... **\$14.95**

(If metal tubes are preferred to glass type, add \$1)

BEAM POWER TUBES TO BE HAD

### AMATEURS:

Model BS-5-AB has same specifications as BS-5 except that it has special bandspread circuit for 20-40-80-160 M bands and is equipped with plate voltage cut-off switch. Add \$1.00 to above price.



## 3-Tube Short Wave Radio

Only \$3.25

(less tubes, phones, unwired)

A REAL, powerful 3 tube short wave set that reads 10 specifications as ER-19, except that it is equipped with plate voltage cut-off switch and special broadcast coils for 20-40-80-160 M bands spreading these bands 80% of dial scale. Add \$1 to price of ER-19. (10 meter band coils if desired extra \$1.45.)

THREE TUBE BATTERY SET, less tubes, phones, unwired \$2.95

TWO TUBE BATTERY SET, less tubes, phones, unwired \$2.00

KITS wired, extra 75c

Tubes, each 50c. Broadcast band coils (2), extra 50c. Cannonball double headphones \$1.35.



**NEW! The HF-25 Beginner's Transmitter**

An inexpensive transmitter capable of delivering a good 20 watts crystal power to the antenna on the 160, 80, 40 meter bands and 15 watts on 20 meter band. Using the new 6L6G in a Tri-Tet circuit allowing operation on two metal chassis housed in a beautiful crackle finished cabinet, antenna tuning unit built in. Eilen silvered transmitting dials, Triplett meter, including set cathode and plate tank coils for any one band. Specially priced at \$11.95, in kit form, including all parts necessary to put in operation except accessories listed below.

Extra: 6L6G \$1.25. Quartz crystal \$1.95 for 80, 160 meter band, 40 meter \$2.50. Crystal holder \$1.00. Coils for additional bands \$1.00 per set.

# NEW!... The Last Word in SHORT WAVE RECEIVERS

## Model RX 20

### An 8 Tube 6L6 Beam Power Audio Electrical Bandspread Receiver. 2 1/2 to 3000 Meters

Our latest development. An 8-tube receiver for the AMATEUR and Short Wave fan, using a tuned RF Stage and tuned Electron coupled regenerative detector. Covers all wavelengths now in use including the ultra high frequencies and experimental bands. A gain control for the entire receiver is included. 5 WATTS OF AUDIO POWER AVAILABLE FOR THE BUILT-IN-FIDELITY DYNAMIC SPEAKER.

For the HAM we offer type AB. Special Band Spread coils covering all the ham bands with individual padding condensers in each coil are included in this model. Also a stand by switch for use during transmission periods. The phone jack is included which automatically cuts out speaker. Built in hum free power supply.

READY TO USE FACTORY WIRED AND TESTED INCLUDING TUBES AND BAND SPREAD COILS FOR THE HAM BANDS AND 200 TO 3000 METERS GENERAL COVERAGE COILS.

Uses the following tubes: 6KT6 tuned RF amplifier, 6K7G tuned electron coupled detector, one 6J5G ultra high frequency oscillator tube, Two 6CG6 audio amplifiers one 6D6G is the noise suppressor and 6L6G BEAM POWER AUDIO OUTPUT TUBE and a 5Y3G rectifier.

For the Short Wave Fan: RX-20H complete as above with coils from 2 1/2 to 3000 meters \$28.95.

For the Amateur: RX-20AB complete as above with special amateur bandspread coils and 200 to 3000 meter coils \$24.95.

RX-20AB Amateur Kit: Includes all parts factory assembled ready to wire no holes to drill or parts to mount and schematic and picture diagram and a beautiful cabinet. KIT OF PARTS, \$19.95. Tubes, \$4.50 EXTRA. Special band spread coils \$1.00 per band for any one ham band.

RX-20R S.W.L. KIT: Same as amateur kit but with regular coverage coils from 2 1/2 to 3000 meters. KIT OF PARTS, \$19.75. Tubes, \$4.50, EXTRA.



## 7C 5-Tube Short Wave Receiver

8 1/4 to 625 meters



Bigger and More Powerful Than Ever A Giant in Performance

FULL 6 TUBE PERFORMANCE plus THE NEW K92A SERIES TUBE makes this an outstanding value. Equipped with a powerful 3 stage audio frequency amplifier.

Uses 6D6-6F7 (twin 2 in 1 tube)—76—K92A-12A7 (twin tube) tubes as RF amplifier, electron coupled screen grid regenerative detector, powerful 3 stage audio amplifier with pentode output stage, rectifier and complete built-in power supply. Operates entirely from 105 to 130 volt AC or DC light socket.

BAND SPREAD TUNING—smooth regeneration control—built-in high quality loudspeaker—automatic headphone jack—large, illuminated airplane type vernier dial—large low-loss inductances. Heavy black shrivel finish metal chassis and cabinet. Must be seen to be appreciated. Satisfied owners report as high as 35 foreign countries on the loudspeaker with this model. You may do the same under fair conditions. ORDER YOURS TODAY! YOU WILL NOT REGRET IT!

EILEN 7C RECEIVER, wired, in cabinet, complete, READY TO USE, with speaker 5 RCA tubes, 4 coils for 8 1/4 to 200 meters, and simple instructions..... **\$12.95**

2 Broadcast Band Coils, extra..... \$1.25

7C KIT, unwired, of necessary parts, 4 coils for 8 1/4 to 200 meters, and instructions..... **\$7.25**

Glossy black cabinet, speaker, tubes..... \$1.25

Beautiful RCA tubes..... \$1.25

5 matched RCA tubes..... 3.15

Special loudspeaker..... 1.45

(2) Broadcast band coils, 200-625 meters..... 1.25

Labor for wiring & testing, extra..... 1.50

SPECIAL: COMPLETE KIT, unwired, cabinet, speaker, 4 coils for 8 1/4 to 200 meters, and simple instructions..... **\$11.45**

2 broadcast Coils, extra..... \$1.25

AMATEURS: Model 7C-AB, same specifications as 7C except that it has special tuning circuit and coils for spreading out the 20-40-80-160 M bands over 80% of dial. Also equipped with plate voltage cut-off switch. Same price as 7C. Model 6B or 6B-AB battery model of 7C. Operates from inexpensive dry batteries. Same price.

Prompt service, 20% deposit on C. O. D. orders

Dept. SC 9, 136 Liberty Street, NEW YORK, N. Y.

# EILEN RADIO LABORATORIES

Please mention SHORT WAVE & TELEVISION when writing advertisers



**A "WORLD-BEATER"**

**The NEW ACE DO-ALL**

DE LUXE SEVEN TUBE HIGH PERFORMANCE COMMUNICATIONS RECEIVER



The ONLY Receiver incorporating ALL of these DESIRABLE FEATURES!

- **TWO TUNED STAGES**  
A positive necessity for extreme sensitivity and "split-hair" selectivity.
- **LATEST TUBES**  
6K7—Tuned R.F. Amplifier.  
6N7—Tuned electron coupled regenerative detector.  
71—U.H.F. 2 1/2 to 10 meter super regenerative detector.  
76—6C5G-6L6 High Fidelity three stage audio power Amplifier.  
5Y4G—Full wave, high voltage rectifier.
- **HEAD PHONE JACK**  
Automatic, complete speaker cut-off—
- **NOISE SUPPRESSOR**  
A remarkable development pioneered by Ace Laboratories. Positive switch control suppresses interfering noise coming out the foreign stations with tremendous volume.
- **2 1/2 to 3000 METERS**  
Your Du-All is never obsolete. It tunes to all bands! Today and tomorrow!
- **BEAM POWER**  
New 6L6 Beam Power tube makes available 8 Watts Clear, crisp Audio output, and loud speaker volume on all foreign stations.
- **DUAL REGENERATION**  
An exclusive Ace feature! Semi-Automatic for peak reception. Manual setting control.
- **FULL BANDSPREAD**  
Separates those weaker foreign stations!
- **AND—**  
Velvet smooth, calibrated controls—Doublet or single antenna input—Self contained, HUMBLESS! Power Supply—Metal tubes for lower background level—Dual panel illumination. Sensitivity, power, selectivity, quality surpassed by none!

**FOR COMPLETE DETAILS**

**DO-ALL DELUXE STANDARD MODEL (9 to 3000 Meters)**  
Six tube Receiver, complete with matched tubes, and cabinet. Nothing else to buy! Not wired!  
Laboratory wired and tested, ready for you to attach antenna, plug into socket, and thrill to new and strange Programs! Price.....  
If tubes, cabinet, and 200 to 3000 meter wavelength range are not desired at present you may deduct from the above Prices.....

**\$1975**  
**\$2175**  
**\$500**

**DO-ALL DELUXE ULTRA MODEL (2 1/2 to 3000 Meters)**  
Seven tube Receiver, complete with matched tubes and cabinet. Ready to be wired.  
Laboratory wired and tested, ready to operate. The entire world of Radio at your command! Complete  
If tubes, cabinet, and 200 to 3000 meter wavelength range are not desired at present you may deduct from the above Prices.....

**\$2375**  
**\$2625**  
**\$500**

**SPECIAL:** An eight page instruction booklet is included FREE with every DO-ALL: including complete, easy, wiring and operating instructions, as well as useful and essential short wave information; check full of illustrations, diagrams, etc.; Booklet available for 25c, postpaid.

**BATTERY OPERATION AC-DC**

FOR VACATION, CAMP, MOBILE WITH THE **"UNIVERSAL-SIX"** FOUR TUBE RECEIVER FOR HOME, HOTEL, PORTABLE

IMAGINE! A compact, self contained, sensitive receiver with real SIX TUBE performance that will operate on any AC or DC house line. Simply plug in a cable and—PRESTO!—a completely battery operated set that you can use in your car, boat, or any other place! The same full toned loud speaker volume—the same thrilling foreign reception—the same ease of operation! No changes in wiring. Really TWO receivers for less than you would expect to pay for only one!

Look at this powerful tube line-up: Screen grid pentode RF stage—high gain regenerative detector—THREE STAGE high quality audio amplification with power pentode output—heater type rectifier and humless power supply. **FULL SIX TUBE POWER** from two dual "Twin" 6P7 tubes and heavy duty 38 and 1-V tubes!

And these features: Full bandspread 9 1/2 to 625 meters—self contained, good quality loud speaker—New Transmitter type tuning dial with dual speed friction drive—Provision for headphones—Indirect panel illumination—Velvet smooth control of regeneration—Operates entirely from any AC or DC house socket OR ON BATTERIES. Low current drain means long, economical life of tubes and batteries.

This receiver is easy to build—easy to operate—and it certainly pulls 'em in! Order your Universal Six now! You will be amazed at the full loud speaker volume of distant stations! Every set is fully guaranteed. Buy with safety!



**ACE UNIVERSAL-SIX** receiver with four tubes, cabinet, all coils, and built-in speaker. COMPLETE, nothing else to buy. Not wired.  
Laboratory wired and tested, complete, ready to plug in.

**\$1275**  
**\$14.50**

**QUALITY ACE RADIO LABORATORIES VALUE**  
227 GREENWICH ST., Dept. C-9, NEW YORK CITY

**ELGIN AIR ROAMER "3"**  
3-Tube Receiver

- Airplane Dial
- Vernier Regeneration Control
- 9 1/2-2000 Meters
- Earphone Jack

Completely outclasses any receiver of similar design. Reaches out and pulls in signals from all parts of the world. Plug-in coils, the most efficient system for short-wave tuning, are employed. The coils furnished with the receiver tune from 15 to 550 meter. Additional coils may be purchased to tune from 9 1/2 to 15 and 550 to 2000 meters. Four tube performance is obtained from the three used. Last 67 combination detector and 1st audio feeds into a 43. A 25Z5 is used for rectification. A 5" dynamic speaker capably handles the full output.



Chassis only with 3 tubes..... **\$11.70** Matched grey wrinkled cabinet..... **\$1.25**

**TRY-MO RADIO CO., INC.**  
85 Cortlandt St., New York City, N. Y.

**806 All-Band Xmitter Delivers 400 Watts**

(Continued from page 227)

**Parts List for 806 Transmitter**

For a complete list of parts used in the 6F6-6L6 portion, refer to the article on the exciter unit on page 704, March 1934 issue. The parts list for the New Driver portion are as follows:

- HAMMARLUND**
- 1—100 mf. variable condenser, MTC-100B
  - 1—5-prong isolantite socket
  - 1—2.1 mh. R.F. socket
  - CORNELL-DUBILIER**
  - 2—.01 mf. mica condensers 600 V.
  - 1—.001 mf. mica condenser 2500 V.
  - 1—100 mmf. mica condenser 5000 V.
  - 2—.001 mf. mica condensers 1000 V. I.R.C.
  - 1—50,000 ohm, 20 watt resistor
  - 1—100 ohm center-tap resistor
  - 1—15,000 ohm 20-watt resistor

**Parts List for Final Amplifier**

- HAMMARLUND**
- 1—50 mmf. per section split-stator condenser TCD-50A.
  - 1—100 mmf. condenser MTC-100R.
  - 1—CH-500 R.F. choke 2.5 mh.
  - BUD**
  - 1—small disc-type neutralizing condenser
  - 1—4-prong push-type jumbo socket

**S-Ws and Long Raves**

(Continued from page 240)

set of beads, a pocket-knife, picture views of my home town and little souvenirs of the coronation, etc. Would you believe it, sir, not one has been good enough to answer my letter!

I do not think that this is at all fair, as I think that I should have received a little note saying that the souvenir was received in good order. I don't think that this is the right way to establish friendship and brotherhood between fellowmen, but I suppose they mean well.

I received a letter from a writer in Scotland and also a copy of *Short Wave & Television* with my original letter printed in it. Since I mentioned the event, all book-sellers seem to be getting a good supply of back numbers now and find a ready sale, three for one shilling.

Wishing your magazine every success, which it fully deserves.

Thomas Mooney  
49 Aylward Road  
Abourthorne Estate  
Sheffield, Yorkshire, England.

**"Spot News" Transmitted by Television**

(Continued from page 217)

reflecting lenses covered by patents. The beam is reflected from this disc onto a transparent screen, suspended about four feet above it. The screen forms the bottom of a shadow box, which has a mirror set in its upper rear portion, and the audience sees the images projected onto the screen as they appear on the mirror.

The television news bulletins are seen about six feet from the floor; they are bright enough to be clearly visible in a room with ordinary artificial light, or in diffused daylight, and large enough to be easily read at distances up to 150 feet. They have been successfully demonstrated in leading Canadian hotels, and will be shown in America, probably upon a commercial basis, within a few weeks after this magazine goes to press.

**Next Issue!**

Special ANTENNA article will appear. Complete data of interest to FANS and HAMS who want to get DX!



# The New 1938 Ultra Stratosphere "10"

## 2½ to 4000 Meters Trans-Receiver

- \*Ten tubes,
- 1—6K7 Regenerative Tuned R.F. Amplifier.
- 1—6J7 Regenerative Detector.
- 1—6J5G Super Regenerative Detector & Transmitting Osc.
- 2—6C5 P.P. 1st Audio stage.
- 2—25L6 P.P. Beam power output stage & modulators.
- 2—25Z6 Parallel Rectifiers.
- 1—6G5 Electronic tuning indicator & R meter.
- \*Receives from 2½ to 4000 meters.
- \*Transmits on 2½ & 5 meters
- \*8" Dynamic Speaker.
- \*Calibrated R.F. Gain Control.
- \*A.F. Gain Control.
- \*Size—17½" x 19½"—16 gauge metal.
- \*Tone control.
- \*R.F. Resonator control.
- \*Separate electrical bandsread.
- \*Vernier planetary drives on tuning Cond.
- \*Large illuminated 8" tuning dials.
- \*May be used for I.C.W. and phone transmission and as a code practice oscillator. Only a key required.
- \*Standby switch.
- \*Automatic Phone jack.
- \*Built-in A.C. & D.C. Power supply.

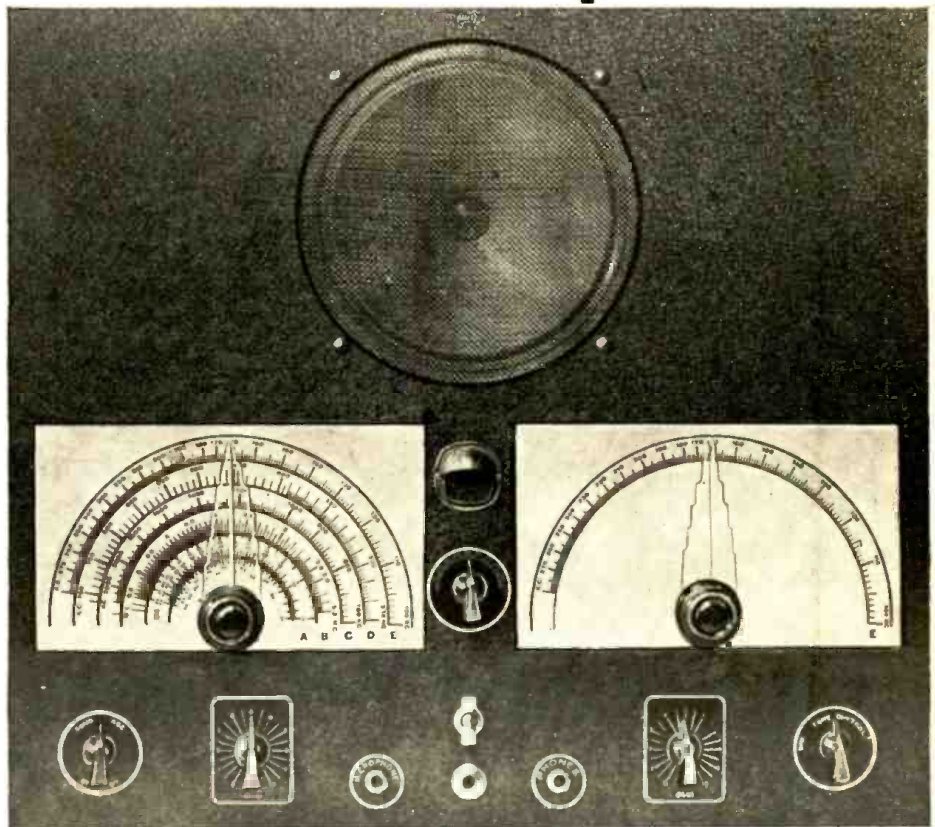

## SENSATIONAL ULTRA "AIR ROVER" 2-TUBE TRANS-RECEIVERS

### A.C., D.C. MODEL

Numerous letters of appreciation received from the many purchasers of the Ultra Air Rover since its release a few months ago pronounces it as the sensation of the year. Never before was a unit of this type available at any price. This compact and self-contained unit will receive from 2½ to 4000 meters with a high degree of excellence. Will receive foreign stations, amateurs, police calls, broadcast, press, airplane and weather reports, time signals, and all ultra high frequency stations. As a 2½ to 5 meter transmitter surprising results will be obtained when calling friends from afar.



### BATTERY MODEL

In compliance with countless requests we have designed a battery model of the now famous A.C.-D.C. Air Rover. This remarkable unit uses 2 twin tubes, 19 & 1E7G which insure consistent loud-speaker volume and powerful transmission. Receives from 2½ to 4000 meters, transmits on 2½ and 5 meters. Cabinet is provided with handle (not shown) for portable use. May also be mounted in a car. The same features which characterize the electric model are incorporated in this unit.

Either kit unwired, less tubes and accessories .....	<b>\$7.15</b>
Set of 2 Sylvania tubes for electric model 6J5G and 12A7.....	\$1.65
Set of 2 Sylvania tubes for battery model 19 and 1E7G.....	\$1.95
Set of 4 coils 2½ to 15 meters.....	.30e
Set of 4 coils 15 to 200 meters.....	.95e
Set of 5 coils 200 to 4000 meters.....	\$1.75
American S.B. Handmike.....	\$2.95
Cabinet less battery compartment.....	.95e
Cabinet with battery and speaker compartment.....	\$2.25
5-inch magnetic speaker.....	\$1.25
Wired and tested.....	\$2.00

Complete kit of parts including 8" Dynamic Speaker, unwired, less tubes and accessories .....	<b>\$18.95</b>
1 Kit of 10 matched Sylvania tubes.....	\$6.95
Set of 4 coils—2½ to 15 meters.....	.30
Set of 8 coils—15 to 550 meters.....	2.20
Set of 4 coils—550 to 4000 meters.....	2.00
American S. B. Handmike.....	2.95
Wired and tested extra.....	4.50

FEATURES	
★ Transmits from 2½ to 5 meters	
★ Receives from 2½ to 4000 meters (12 bands)	
★ Separate electrical and mechanical bandsread	
★ Loud speaker volume	
★ Automatic super-regeneration from 2½ to 15 meters	
★ House to house communication	
★ Plate modulation	

**Ultra High Frequency Products Co., 123 Liberty St., New York**

Please mention SHORT WAVE & TELEVISION when writing advertisers



# 20 Instruments in One

Price is **\$10<sup>40</sup>**  
Only



The Allmeter is the Season's Biggest Sensation!

The Allmeter, a 1,000-ohms-per-volt d'Arsonval instrument, instead of being just a volt-ohm-ammeter, is such an instrument plus a.c. readings for voltages and currents, also accurately measuring very low resistance, from below one ohm, also high resistance, capacity, henries and decibels, comprising twenty instruments in one. For a.c.-d.c. use.

0-15-150-750-volts and milliamperes, a.c. and d.c.  
-12 to + 30 decibels .03-500 ohms  
500-500,000 ohms 5-1,000 henries  
.01-50 mfd. Continuity Tester

# Incomparable Signal Generator

Our new generator has the following features:

1. Direct reading in frequencies, 100 kc—22 mc, in five bands, all fundamentals, by front-panel switching. Ultra band by harmonics to 105 mc, also direct-reading.
2. Direct reading in frequencies, 25-10,000 cycles, in three bands, all fundamentals, by front-panel switching.
3. R.F. and A.F. outputs independently obtainable alone, or with A.F. (any frequency) modulating R.F.
4. Output meter.
5. R.F. attenuation.
6. Condenser and other leakages to 100 megohms.
7. Main dial protracted on 7 1/2" diameter, precision pointer 4-to-1 vernier planetary drive.
8. All services on 90-130 volts a.c. or d.c.

**\$14<sup>40</sup>**  
PRICE

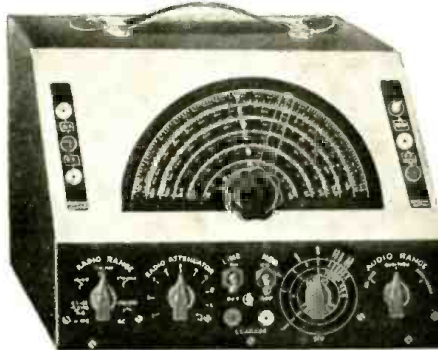

Send for our Free Catalogue PV in colors!

**SUPERIOR INSTRUMENTS COMPANY** 136 LIBERTY STREET  
Dept. SW-9, New York, N. Y.

# New "Electron Gun" Projects Large Television Images

(Continued from page 214)

with a much smaller and brighter picture than in the case of a "Kinescope," which is viewed directly. Since the brightness is dependent on the current in the beam, the smaller picture requires a much larger beam current in a smaller "spot."

The television images shown were on the 441 line standard, which RCA adopted some months ago for its practical field tests. Despite the enlargement, it was difficult if not impossible for the eye to detect *line scanning* or other details by which the illusion of direct vision was accomplished.

The detailed construction of the newly devised electron gun which makes this advance possible calls for specifications so rigid that the idea was nearly discarded as impracticable, when first proposed. A flood of electrons must be regimented into the solid column of a narrow beam, to "paint" the received picture more vividly on the fluorescent screen of the "Kinescope." The electrons are "conditioned" for the job by being passed through three metal discs, each having an aperture in its center about the diameter of a pencil lead. Then, they pass through a fourth and last disc, similar to the others, but with an opening too small to pass a human hair. Electrons are made to pour through this tiny opening to the fluorescent screen at the tube's end. The bombardment is so intense that the light produced on the screen of the projection "Kinescope" may be spread over an area 100 to 400 times greater in a projected picture.

Although it is regarded in scientific circles as a distinct technical advance in RCA's television developments, engineering opinion is that Dr. Law's contribution could not at this stage be incorporated in home television receivers.

# REPLACE

**WORN-OUT DOWN-LEADS WITH LYNCH GIANT KILLER CABLE**

1. Efficient in all weather
2. Insures greatest signal strength
3. Outlasts ordinary down-leads by many years

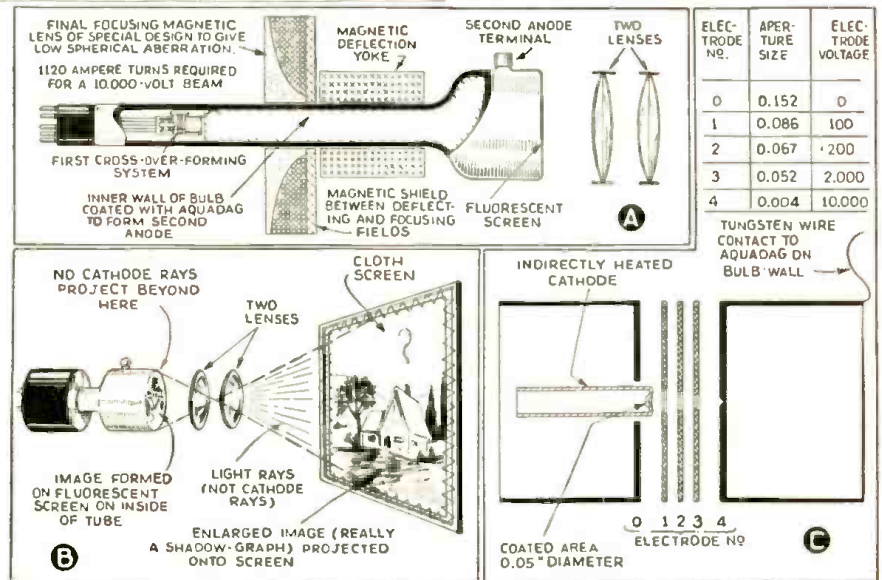

# World S-W Station List

(Continued from page 243)

5.000	TFL	REYKJAVIK, ICELAND, 60 m. Works Europe nighttime irregularly.	4.600	HC2ET	GUAYAQUIL, ECUADOR, 65.22 m., Addr. Apartado 249. Wed. and Sat. 9.15-11 pm.
4.975	GBC	RUGBY, ENG., 60.3 m. Works ships irregularly.	4.272	WOO	OCEAN GATE, N. J., 70.22 m., Addr. A. T. & T. Co. Works ships irregularly.
4.820	GDW	RUGBY, ENG., 62.24 m. Works N.Y.C. nighttime irregularly.	4.250	RV15	KHABAROVSK SIBERIA, U. S. S. R., 70.12 m. 1-10 am.
4.790	VE9BK	VANCOUVER, B. C., CAN., 62.63 m., Addr. Radio Sales Service, Ltd., 790 Beatty St. Except Sun. 11.30-11.45 am., 3-3.15, 8-8.15 pm.	4.107	HCJB	QUITO, ECUADOR, 73 m. Daily 7:30-8:45 am. Daily except Mon. 11.30 am.-2.30 pm., 5-7 pm., 7-10 pm.
4.752	WOO	OCEAN GATE, N. J., 63.1 m., Addr. A. T. & T. Co. Works ships irregularly.	4.098	WND	HIALEAH, FLORIDA, 73.21 m., Addr. A. T. & T. Co. Works Bahamas irregularly.

World's Largest Makers of Antenna Systems  
**L. S. BRACH Mfg. Corp.**  
Newark, N. J. Est. 1906

**CHASSIS—CABINETS  
PANELS & CANS**  
STANDARD SIZES ON HAND  
SPECIAL SIZES MADE TO ORDER  
**KORROL RADIO PRODUCTS CO.**  
Dept. S-9  
232 Greenwich St., New York City

Please mention SHORT WAVE & TELEVISION when writing advertisers



## Short-Wave Transmission and The Ionosphere

(Continued from page 218)

improvement in our understanding of these processes as they take place in the ionosphere. On frequent occasions—about 100 times in 1936—fade-outs of short-wave radio signals have been reported. About half of these cases occurred simultaneously with the appearance of flares of hydrogen light upon the sun, and it is likely that a large number of the remaining cases were also accompanied by hydrogen flares, but no astronomer happened to be looking at the sun at the time to report them.

The most outstanding occurrences of these fade-outs during 1936 were on April 8, August 25, and November 6. All short-wave transmission on the daylight side of the earth was completely knocked out for about an hour in each case, and many receivers were probably torn down to discover the cause of the fade-outs. Even commercial stations, operating on 8 and 13 mc. with plenty of reserve power, could not maintain communication. If the transmission-path between stations lay on the dark side of the earth or near the twilight zone, communication between them was unaffected. Other terrestrial phenomena accompanied these pyrotechnic displays on the sun which are best illustrated by Figure 1.

At the top of the figure is shown a photographic record of radio signals reflected from the ionosphere directly overhead the transmitter and receiver being located in a building at the Huancayo (Peru) Magnetic Observatory of the Department of Terrestrial Magnetism of the Carnegie Institution of Washington.

### How Reflected "Sigs" Are Recorded

This equipment for study of the ionosphere works in the following manner: A short pulse of radio waves is emitted from the transmitter ten times a second. This pulse when received actuates an oscillograph mirror, which by means of an auxiliary rotating mirror reflects a beam of light upon a slowly moving sheet of photographic paper. When the ground wave is received the light-beam makes a mark on the photographic paper. A few thousandths of a second later when the pulse reflected from the upper atmosphere is received, the rotating mirror has turned sufficiently so that the mark for the reflected wave is made some distance above the mark for the ground wave. The distance between the ground wave mark and the reflected wave mark is thus a measure of the time required for the pulse to travel to the reflecting layer and return to earth, and hence a measure of the height at which reflection occurred, since radio waves travel with a velocity of 300,000 km. per sec. As the photographic paper slowly moves along the series of dots so produced forms a line. The wave-length of the transmitted wave is varied at intervals and in this manner the ion-density at various heights is determined.

After 11<sup>h</sup> 46<sup>m</sup> E.S.T. on April 8 the radio operator at Huancayo ceased to receive reflections from the ionosphere. Suspecting that something was wrong with his equipment he examined the set and found it perfect. No reflections could be obtained on any frequency between 2 and 9 mc. until 12<sup>h</sup> 40<sup>m</sup> E.S.T. At this time reflections were returned and they revealed conditions of all layers had remained unchanged. Two other records of fade-outs, occurring on May 28, 1936 are shown in Figure 2. In this case observations were being made on a fixed frequency of 4.8 mc. The lower solid line is the ground wave received, the next a weak border reflection from the lower or E-layer, and the upper line is a regular reflection from the F<sub>1</sub>-layer. The record shown indicates that in each case the weak border reflection fades out more easily than the strong F<sub>1</sub>-reflection.

While measurements of the sort conducted at Huancayo and at a few other places reveal exactly what happened, short-wave

# HAYNES R-S-R CLIPPER

## 5-TUBE COMMUNICATION RECEIVER NOW IN KIT FORM!

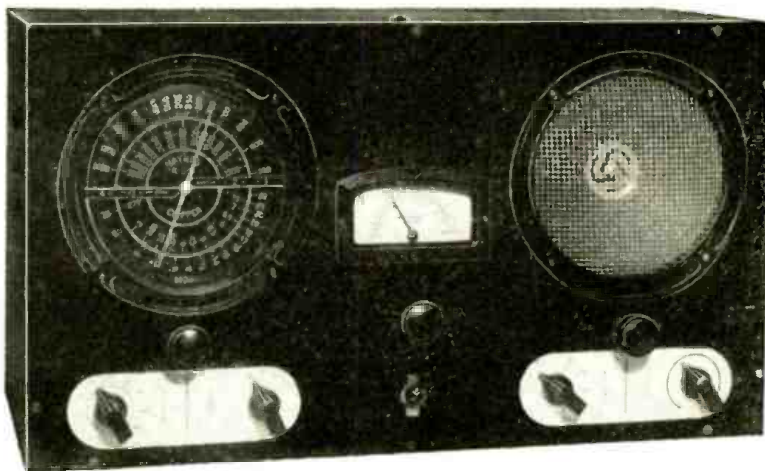

For the first time, in response to hundreds of requests, we have decided to make this finest of all the regenerative receivers available to the man who prefers to "build his own". BUT THAT'S NOT ALL! The CLIPPER KIT comes to you COMPLETELY ASSEMBLED, ready to wire. All the mechanical work is done. No question of parts fitting or where they belong. We have consistently refused to sell the CLIPPER in kit form to date. We knew, from comparative tests, that it was the finest regenerative receiver available today and we were not willing to jeopardize its reputation by selling it in any manner except completely built and tested. The CLIPPER'S record as the best regenerative receiver for unusual long distance reception is now so well established that we feel we no longer need hesitate to offer it in kit form. We are, however, taking the added precaution of completing the mechanical assembly work so that there can be no question of its mechanical ruggedness, so necessary to its precision tuning and extreme bandspread on the high frequencies.

Every slight change and modification which Mr. Haynes has suggested to us for improving the CLIPPER circuit, since it was first developed, has been incorporated in this new kit. 6L6 Beam Power output; 6 inch dynamic speaker; 3 to 350 meter tuning range in seven separate bands and all its other well known features, too numerous to list here, are included in this de-luxe kit at a price which will make it possible for hundreds of new owners to join the ranks of CLIPPER DX hunters. And please note: To give you the benefit of the lowest possible price, this new kit will be sold only direct from our laboratories to you.

HAYNES R-S-R CLIPPER KIT, completely assembled ready to wire with built-in AC power supply, 6" dynamic speaker, 5" calibrated tuning dial, etc. Less only tubes and cabinet..... **\$16.85**

Five matched Sylvania tubes: 2 6J5G, 1 6K7, 1 6L6C, 1 80—\$3.90.  
Cabinet: heavy steel with hinged top. Black crackle finish \$3.10  
CLIPPER completely wired with tubes and cabinet ready to operate (additional 600 to 1600 meter band may be had if desired at same price in complete set only).....\$28.85



## R-9 SIGNAL BOOSTER

WILL GIVE YOUR WEAK DX SIGNALS A TREMENDOUS BOOST. Try this new unit ahead of your CLIPPER if you want a thrill! Can be used with any receiver that operates from A.C. Selectivity increased tremendously!

Weak stations brought up to loudspeaker volume!  
A handwired preamplifier (4 bands—no plug-in coils). Tunes from 14 to 560 meters with overlaps on each band. If you are interested in long distance reception you need a signal booster regardless of what receiver you are using. The R-9 not only gives you extreme selectivity, preventing interference from other stations, but it gives you, at the same time, maximum regenerative amplification of the station you want before it even reaches your receiver.

In ordering, specify what output tube is used in your receiver. R-9 SIGNAL BOOSTER with 6K7 tube complete in cabinet ready to operate. List price \$18.75. SPECIAL EXPERIMENTER'S INTRODUCTORY PRICE **\$11.25**

## THE AC-4

### 4-Tube Communication Receiver

An outstanding achievement. A truly fine regenerative receiver covering the tremendous tuning range of 2½ to 555 meters. A. C. operation with built-in power supply. Isolantite insulated bandspread and high-frequency tuning condenser. Super-regeneration on the 5 and 10 meter band. Separate volume and regeneration control. Antenna coupling control on front of panel. Straight-line frequency tank condenser. Jack for earphones, cuts out speaker. Standby switch, etc. Uses three of the new 6J5G super-triodes with 80 rectifier.

The AC-4 stands in a class by itself among long distance low price receivers. It is the greatest "miles per dollar" value in radio; a real communication receiver with perfect bandspread—the 20 meter amateur band, for instance, one of the most fascinating DX bands which is only 400 kilocycles wide, covers 100 degrees on the big 3½" German silver bandspread dial with NO hand capacity effect. On foreign reception you will be amazed at the way the AC-4 separates the crowded foreign stations on the short-wave bands. Price, AC-4; complete kit of parts, drilled chassis, speaker, etc. Less only cabinet and tubes, unwired..... **\$10.75**  
Crystalline finished metal cabinet..... **\$1.25**  
Kit of four picked Sylvania tubes..... **2.05**  
Wiring and testing..... **2.50**

SPECIAL PRICE ON COMPLETE AC-4: wired, tested and ready to operate from any 110-volt line..... **\$15.85**

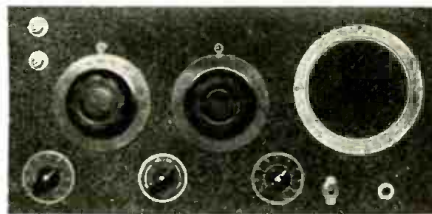

Radio Constructors Labs.



136 Liberty St., Dept. S-9  
N.Y.C., N.Y.

Please mention SHORT WAVE & TELEVISION when writing advertisers



# Utah C. W. and PHONE TRANSMITTER KITS

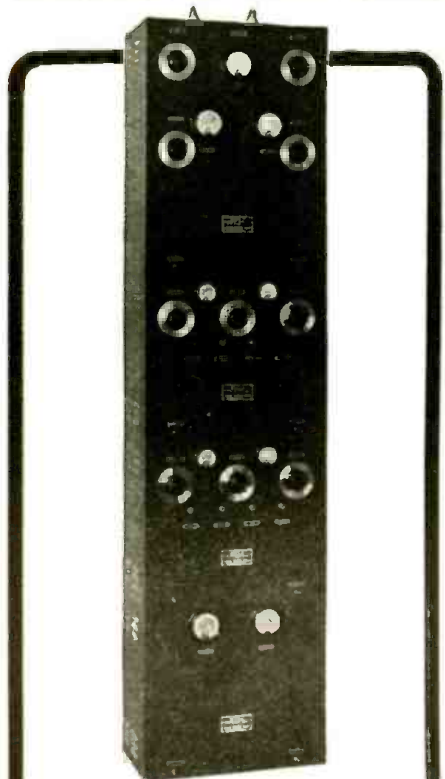

### The Most Flexible Transmitter Kits Available Today

80 Watts C.W. 80 Watts Phone  
500 Watts C.W. 500 Watts Phone

• Self-Contained Power Supply for each Unit • Designed for Rack Mounting, or Speech Amplifier may be located at operating station. • Exciter Unit may be used as separate emergency unit or as 80 Watt Portable Transmitter. • No extra parts required when connecting for phone or C. W. • Link Coupling used throughout • Universal Antenna Coupler "Link coupled" • Every circuit properly metered • All bands on 2 or 3 crystals. • No. 2 kit makes an excellent P. A. amplifier. • Easily constructed • Lowest prices. See these outstanding Transmitter Kits at your dealer today or write Dept. SW9 for complete information.

UTAH RADIO PRODUCTS CO. Chicago, Ill.

Toronto, Ont. Canada Buenos Aires, Ucoo Radio Products Co.

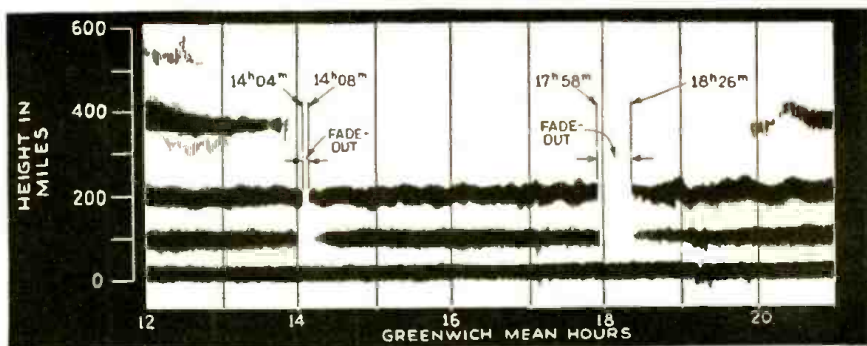

Figure 2—Examples of radio fade-outs, Huancayo Magnetic Observatory, May 28, 1936

operators elsewhere were aware of these unusual conditions as revealed by reports from numerous amateur and commercial stations throughout the sunlit hemisphere. Many inquiries have been made as to the nature and cause of these fade-outs.

### Cause of Short-Wave "Fade-out"

Figure 1 demonstrates that the fade-out of April 8 (and this is true of many others) occurred simultaneously with the appearance of sudden brightening of hydrogen light in the region of a sunspot. It was accompanied by an unusual change in the earth's magnetism and in the natural electric currents flowing in the earth. Assembling all the facts scientists have been able to arrive at a reasonable explanation of these phenomena. With the emission of visible light from the sunspot region, intense ultraviolet light is also given off which is capable of ionizing the gases of the high atmosphere. The wave-length of these ionizing radiations is less than 1/100,000 of a centimeter, which makes them capable of setting electrons free from some of the air molecules. So sudden is this blast of light that within a minute, the number of free electrons or ions in the lower part of the ionosphere has increased enormously. Owing to the large number of air molecules present, this intense ionization instead of forming a reflecting layer—forms an absorbing layer for short waves. Short waves passing into it set the electrons and ions into motion. Before the electrons and ions can re-radiate their energy back to the earth, they lose it by colliding with the molecules present, thus dissipating the energy of the radio waves.

Like the traveler in Aesop's fable who could blow both hot and cold from the same mouth, these solar flares have a reverse effect—long waves, which are reflected from the lower regions of the ionosphere through which short waves ordinarily pass, are reflected more strongly at these times. R. Bureau reports that atmospherics of wave-length about 10,000 meters come in much more strongly during these short-wave "fade-outs." This is due to the fact that, owing to their great wave lengths,

many more electrons and ions can participate in the reflection of these waves.

Fortunately, short-wave fade-outs of this type can occur only during the daylight hours. They are most pronounced around noon. While short-wave fade-outs may cause considerable inconvenience for both amateur and professional operators at times, they have more than paid for this inconvenience by improving our understanding of the ionosphere and the mechanism of long-distance short-wave transmission.

### S-W "Fade-outs" Connected With Sun-spots

During the past few years short-wave fade-outs have been comparatively rare, but recently they have become numerous. This is due to the increase in the number of spots upon the sun, for practically every hydrogen flare which causes a short-wave fade-out originates in the region of a sunspot. This increase in sunspots will continue for a year or two until the sunspot maximum will have been reached. Then the number of sunspots will decrease again, all of which leads to another important consideration.

In addition to the sudden ionizing effects causing fade-outs the normal ionizing power of the sun varies enormously from sunspot minimum to sunspot maximum, which has a striking effect on short-wave transmission. Terrestrial magnetic observations extending back over a century show that there is a close connection between the condition of the ionosphere and the number of spots upon the sun. Scientific radio observations in recent years have shown a close agreement with terrestrial magnetic phenomena, from which it follows that the sunspot relationship must also hold for radio. However, the effects on short-wave transmission far exceeds what was anticipated from the terrestrial magnetic effects. The most pronounced changes occur in the uppermost or F<sub>2</sub>-region of the ionosphere, which plays the principal part in short-wave transmission. During the past few years average electron-densities in the F<sub>2</sub>-region have increased greatly. In terms of critical frequency this means that

QUALITY recommends

# Condensers by SOLAR

WET ... DRY  
PAPER  
MICA ... THIMMER



Please Write for Details

SOLAR MFG. CORP. 599-601 Broadway New York City

### FOR SALE: ELECTRIC SPECIALTY D.C. GENERATORS—

all in good condition:  
400/15 volts, 5/30 amps.  
750/15 volts, 2/30 amps.  
500 volts, 1 amp.  
1000/17 volts, 17/24 amps.  
1500 volts, .4 amps.

Price, while they last \$18.00 each f.o.b. Bridgeport.  
Electric Maintenance Service Co., Inc.  
679 Warren Street Bridgeport, Conn.

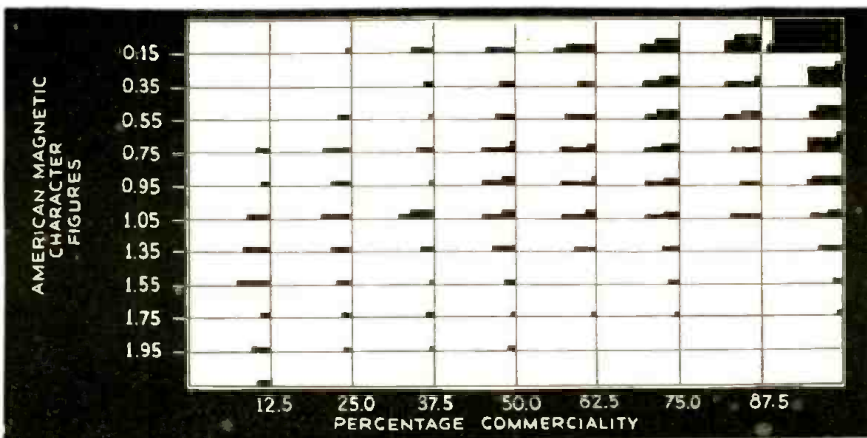

Figure 3—Relation of magnetic storminess and quality of trans-Atlantic radio reception on individual days, May 28, 1928, to December 31, 1930.

Please mention SHORT WAVE & TELEVISION when writing advertisers



wave-lengths are reflected by this layer now which previously penetrated it and passed off into space.

An illustration of this change has been supplied by an amusing consequence of incomplete understanding of the ionosphere and factors affecting radio transmission. A few years ago certain stations were assigned frequencies for short-distance transmission so high that the signals would penetrate the ionosphere and pass off into space, instead of being propagated for great distances. To the amazement of listeners the increased ion-density during recent years caused these frequencies to be heard across the Atlantic—a thoroughly unanticipated result.

**Ultra Short-Wave Range to Increase**

During the period of sunspot minimum which occurred around 1922, trans-Atlantic communication on 15 mc. was not reliable. On the other hand 45 mc. has been heard across the Atlantic during recent months following the increase in sunspot-numbers. Perhaps during the next few months the sunspot maximum which seems to be approaching may exceed the preceding one and permit long-distance communication on short waves of exceedingly short wave-length. It is unbecoming that a scientist should indulge in speculations of this nature, but there is evidence suggesting that the sunspot maximum which is approaching will be the greatest that has occurred since the vogue of amateur radio. Those interested in the advancement of scientific knowledge will perform a real service if they experiment in long-distance communication with extremely short wave-lengths. It may be possible during the next few months or years to achieve long distance communication on 50 or 60 mc.\*

\* 5 meter (59mc.) signals have already been heard across the Atlantic.—Editor.  
(5 meter region). It should be pointed out that the experiments suggested should be carefully conducted. Long-distance communication on these frequencies cannot be accomplished regularly. Perhaps on one or two days success may be attained. The writer of this article would be glad to receive information concerning any authenticated cases of long-distance communication on ultra-short waves.

**"Sunspots" Serve As Index of Solar Activity**

While these variations in the ionosphere are frequently attributed to sunspots, it is necessary to recognize that the sunspots are probably not the cause of the effects but rather an index of a more fundamental phenomenon—variations in the activity of the sun. Our sun is a variable star the radiations from which vary in intensity over an approximately 11-year period. The changes which take place in the radiations capable of ionizing our atmosphere are most pronounced although their results can be perceived only indirectly. These are the radiations which play a leading role in short-wave phenomena.

It is believed that at times of sunspot maxima the sun intermittently sends out clouds of corpuscles traveling through space at a speed of about 1,000 km. per sec. (600 miles per sec.) These corpuscular clouds are assumed in order to account for the aurorae and sudden changes in the earth's magnetism called "magnetic storms." Mathematical analysis has revealed that these magnetic storms result from processes taking place in the upper atmosphere, caused, it is presumed by some solar action. During magnetic storms aurorae flash in the arctic and antarctic skies, particularly brilliant aurorae accompanying the more intense storms. The consequent changes in radio conditions are striking and significant.

These effects are best illustrated by recitation of the events occurring during a recent magnetic storm. This storm began around noon E.S.T. on April 24, 1937, and continued through April 28, on which day it attained its maximum intensity. (This stormy interval probably involved three distinct storms, one directly after another.) During this period, short-wave

**Operators Out For DX Records Are Using This Receiver**

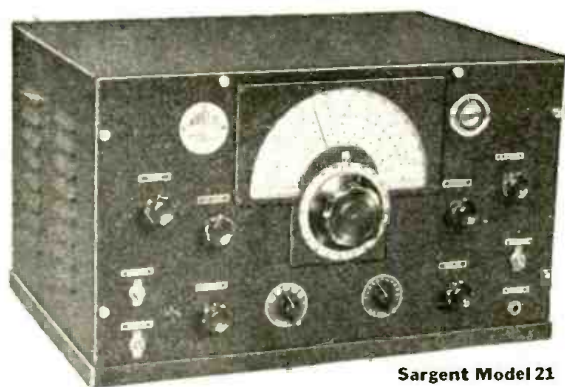

Sargent Model 21

**Regenerative Input**

A receiver is no better than its input circuits. Signals lost here can never be retrieved later in the circuit by any amount of amplification. One of the most important functions of a good receiver is to provide low impedance paths to conduct the extremely weak signal currents from the antenna to the first tube. The efficiency with which this is done is a direct measure of the DX range of the receiver. This is the reason REGENERATIVE INPUT, the most sensitive known circuit arrangement, is used on Model 21.

**About the "LC Ratio"**

Before you buy your next super-het, look "under the hood." Check up on the "L/C" ratio at the dial settings used for amateur band reception. High L/C ratio is extremely important for weak signal reception.—for DX. For greatest DX range tuning condenser should be almost entirely out of mesh. Model 21 has been designed so as to give this favorable tuning condition to the 10, 20, 30, 40, 75 and 80 meter amateur bands. Under these favorable conditions, weak signals are heard that are frequently lost when tuned with a large capacity setting. This is just one of the many design features that make Model 21 the DX man's receiver.

**Red Hot on 10 Meters**

High L/C ratio and regenerative input dig those weak 10 meter signals "out of the mud." Model 21 really steps out on this band. Ten meter signals travel special circuits from antenna to 1st detector. This is really a 10 meter receiver within an all-wave set. You don't know what really good 10 meter reception is until you have tried this one.

**COMMERCIAL MODEL**

Continuous tuning, 9.5 to 3750 meters, makes Model 21 suitable for many commercial installations. Panel is rack size. Operation is stable, efficiency is high throughout. This receiver is excellent on 600 meters, the heaviest and true signal bands, in addition to its regular short wave and broadcast coverage.

**A. C. OR 6 V. BATTERY**

Furnished for either tuning range at \$3.00 higher than the A.C. price. Excellent for portable or direction finding work.

**NET PRICES**

(Effective May 15th)  
Model 21-AA, 9.5-550 meters.....\$139.00  
Model 21-MA, 9.5-3750 meters..... 155.00  
These prices include R.C.A. tubes, power supply, Jensen Speaker and speaker cabinet.

**E. M. SARGENT C**

Cable Address "EMSCO"  
212 Ninth Street Oakland, Calif.

operators were greatly perturbed. Persons listening to ordinary broadcast programs heard the familiar announcement many times: "Due to atmospheric conditions beyond our control we are unable to bring you the program scheduled for this hour." Auroral displays of unusual brilliance were seen in many places. Short-wave communication was particularly poor during much of this time.

**Effect of "Magnetic Storms" on S-W North Atlantic Circuits**

Figure 3 shows a plot in which short-wave transmission conditions, measured in percentage of time North Atlantic (short-wave) circuits were available for commercial service, is coordinated with the American magnetic character—figure, a measure of the amount of magnetic storminess. A small black area is put in one block for each day indicating the degree of storminess and the percentage of time during which commercial traffic could be carried. On days when the magnetic storminess was a minimum, character-figure 0.15 or less, the circuits could be used commercially nearly all day or all day, while the magnetic storminess was a maximum, the circuits were available less than 12.5 per cent of the time. These results apply when the radio transmission is over a path passing within about 20° from the geomagnetic pole, located in longitude 69° east, latitude 78.5° north. Transmission over paths traversing equatorial regions is not severely affected. Use was made of this important fact by commercial companies during the recent magnetic storm in April. Communication with European stations was maintained by routing the traffic through Buenos Aires.

An attempt to explain these idiosyncrasies of short-wave transmission at the present time would be hazardous, as sufficient data are not yet available as a basis for definite conclusions. Observations show that during times of magnetic disturbance the ion-densities in the F-region, upon

SEE YOUR **JOBBER**

PLUG and SOCKET CONNECTOR

SPRING CABLE PROTECTOR

**MODEL D-104**  
Favorite of the Amateur

A quality crystal microphone especially adaptable for voice transmission. Output level —54 DB (conservatively rated). New redesigned case. List Price \$22.50.  
Licensed under Brush Development Co. Patents.

**ASTATIC Microphone Laboratories, Inc.**  
Dept. SW YOUNGSTOWN, OHIO

**WHOLESALE Radio CATALOG (FREE)**

Save Money on Radios! Reserve your copy NOW of this new 1938 Catalog No. 89-417. More than 50 models of LAFAYETTE radio sets, from 9.95. Complete Form Radios for 19.95. Over 10,000 Bargains in tubes, parts, kits, tools, etc. Everything at lowest Wholesale prices. Write at once—it's FREE.

**WHOLESALE RADIO SERVICE CO., Inc.**  
104 J SIXTH AVENUE • NEW YORK, N. Y.

Please mention SHORT WAVE & TELEVISION when writing advertisers



Well train **YOU QUICKLY**  
for **Good FULL-TIME**  
and **SPARE-TIME Jobs in**  
**ELECTRICITY**

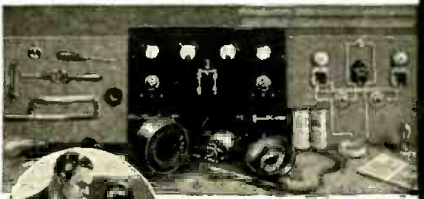

**Train for a Better Job and a Future**  
Train in your Spare Time  
by PRACTICAL Shop Methods  
**WITHOUT LEAVING HOME**

Now, Electric Institute brings—**TO YOUR VERY DOOR**—practical training necessary for the rich rewards in Electricity. Keep your present job—no need to leave home—now you learn **ELECTRICITY** easily, practically—**RIGHT AT HOME**—in your spare time.

**PREPARE TODAY FOR OPPORTUNITIES AHEAD**

Get into a real money making field where there are many opportunities in Electricity. There is no better way to succeed than to **TRAIN** for work in an industry that is expanding. New Electrical projects constantly mean more jobs for men with practical training. Almost every industry uses **TRAINED ELECTRICAL MEN**. Or you can own and operate an electrical business of your own.

**Opportunities to Earn Up to \$5, \$10 a Week or More While Training**

With this amazingly easy, fascinating method of **HOME SHOP TRAINING** it is possible to start **EARNING MONEY** almost at once. Do not confuse E. I. Training with dry, theoretical text book courses. Electric Institute tells you exactly **WHAT to do—THEN YOU DO the ACTUAL JOBS with ELECTRICAL EQUIPMENT and APPARATUS** which comes with your training at no extra cost.

Become a **TRAINED** man without leaving home or your present job—then be ready to step into a **REAL ELECTRICAL JOB**.

**Money Back If Not Satisfied**

You must be satisfied. We give you an agreement to return every cent you pay on tuition if, after completing our training, you are not satisfied in every way with our instruction, equipment or other services given you.

With our training, our graduates receive life time consultation service, employment service and many other features to help them succeed in Electricity.

Electric Institute is ready to show you the way in the great, growing field of **ELECTRICITY**—where trained men are **ALWAYS NEEDED**. Mail coupon **TODAY**—for big, free book of facts about this revolutionary **Practical Home Shop Training** and the tremendous opportunities in **ELECTRICITY**.

**DIESEL ELECTRIC POWER, RADIO and REFRIGERATION**



Take advantage of the opportunities awaiting trained men in these and many other branches of Electricity, with **ELECTRIC INSTITUTE** practical training. Mail coupon for complete facts about **ELECTRIC INSTITUTE**—it may be the turning point in your life.

**RUSH THE COUPON—TODAY—BIG BOOK FREE**

H. W. Petersen, President  
Electric Institute, Inc.,  
Dept. 167M, Hinsdale, Illinois  
Send Free Book with all facts about E. I. Home Shop Training.

Name.....Age.....  
Address.....  
City.....State.....

which reflection of short waves depends, are greatly diminished. On the other hand some observations show that in the neighborhood of the auroral zone—the region 20° from the geomagnetic pole—an absorbing layer is formed at low heights, preventing the transmission of short waves. Which of these effects is predominant in interruption of radio communication will be solved by further investigation. The fact is that *short-wave* communication is seriously impaired or lost completely during great *magnetic storms*, regardless of whether this is due to decreased ionization, creation of absorbing layers, or breaking down of the sharp ion-boundaries necessary for good reflection.

The effects occurring during magnetic storms are not to be confused with the sudden *fade-outs* caused by hydrogen flares on the sun. The latter are clearly caused

by creation of an absorbing layer at the base of the ionosphere and are experienced on the daylight side of the earth only. Magnetic storms influence short-wave transmission over the entire earth, principally where transmission paths traverse high latitudes.

This brief account serves only to outline the profound and perplexing problems involved in trying to account for all the phenomena of radio wave transmission. Many important considerations have not even been mentioned. This is a new field of research in which, month by month, our knowledge and understanding is increased. It is important not only because of the scientific significance of the conclusions which are being drawn, but because its many ramifications also have an intimate connection with the daily life of the whole civilized world.

**“Ghost Echo” Detector to Reduce Plane Crashes**

(Continued from page 214)

therefore permit us to eliminate or at least neutralize their influence with known physical means.

An apparatus for this purpose appears in Fig. 1, which shows a new German *direction finder* device, which does not operate with the usual pair of head-phones or a loudspeaker as an indicator, but utilizes an optical indicator to do the trick. The outfit does not look very different from those applied in this country. We see at the left a loop antenna of usual design, which may be turned by a shaft-drive fitted with a suitable hand-wheel, and at the right side of the table there is placed the receiver (a).

The new features of this direction-finder are the cathode ray tube installed in a cylindrical box with a dial attached directly to the shaft of the loop. The dial operates via remote control the receiver at the right. The receiver in the center is one of the all-wave communications type, and has no direct relation to the new device to be described.

Now let us assume that an airplane requests this ground station to determine its position and it is just shortly after sundown. After all the explanations we have given we will not be surprised to learn that in this specific case one of those famous “ghost echoes” makes the maximum or minimum indications so “broad” that the direction-finder device, (when operated with a pair of head-phones) will surely produce a wrong indication of position. A position report of this kind, and especially if some other unfortunate factors coincide, may have fatal consequences.

And now let's see how the new device eliminates mistakes of this kind. Instead of using a pair of headphones to adjust the direction-finder, the operator observes the screen of the cathode-ray-tube. If no “ghost echoes” are present, an image appears as shown in “a” of Fig. 4. However, if an image of the type shown in “b” or “c” flashes over the screen the operator will be much more careful in adjusting the direction-finder. He will disregard the “ghost images” and try to obtain a clear-cut image of the direct signal only. His findings, which he reads in degrees from the azimuth-circle of his loop-drive,

will (when compared and combined with the findings of another, or *third* ground station) indicate the exact position of the plane. This verified result will be sent at once via radio to the plane which requested the information.

Considering the high speed of modern airliners one doesn't need much explanation to understand that operators of *ground stations* have to work quite fast in order to obtain exact results, and speedy operation is the most important quality of the new Telefunken direction finder. Regardless of the fact that *ghost echoes* are present or absent, the optical method of indication and adjustment permits much faster and more exact work than is possible with the old-fashioned headphone checking method.

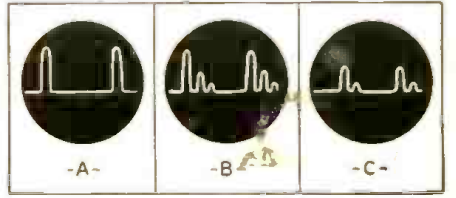

**WHAT A GHOST ECHO LOOKS LIKE**

The diagram above shows three examples what the operator at a ground station sees when a plane requests his assistance, but the plane's signal is received with ghost echo and without ghost echo.

(A) Plane's radio request received in the late afternoon hours. Only one signal is visible, no “ghost echoes” are there to confuse the operator and to send the plane into a crash.

(B) Image of a plane's signalled request for assistance received at the end of the sunset. The little peaks are “ghost” echoes.

(C) The operator turns the loop antenna 90°; one ghost echo disappears. Then he tunes to the “real” signal, until maximal indication is obtained, and the finding of his operation is sent via radio to the plane in distress in the form of an exact report of its bearing and position.

**New 1.5 Volt Tubes Work on Dry Cell**

(Continued from page 233)

**RK-43**  
Twin Triode Amplifier (Filament Type)  
Bulb—T-9 Base—Standard 6-Pin  
**DIMENSIONS**  
Maximum Overall Length—4"  
Maximum Diameter—1 1/8"  
**BASING—R.M.A. Numbering**  
Pin 1—Filament +  
Pin 2—Plate (Triode 2)  
Pin 3—Grid (Triode 2)  
Pin 4—Grid (Triode 1)  
Pin 5—Plate—(Triode 1)

Pin 6—Filament —  
**RATINGS—Each Triode**  
Filament Voltage—1.5 volts  
Filament Current—0.12 amp.  
Plate Voltage—135 max. volts  
Grid Bias—-3 volts  
Amplification Factor—11  
Plate Resistance—13800 ohms  
Transconductance—800 umhos.  
Plate Current—4.5 ma.  
Plate Current (Zero Bias)—7.5 ma.  
This article has been prepared from data supplied by courtesy of Raytheon Production Corp.

Please mention **SHORT WAVE & TELEVISION** when writing advertisers



# How to Photograph Television Images

(Continued from page 219)

while the second half is scanned in another 1/50 second, the two halves being interlaced.

In this system the time taken for one spot of light to travel its own length is .00000017, so a one-second shutter exposure gives the emulsion an exposure



One of the lady announcers. This is an example of watching one's chance. It was noticed that the announcer kept looking down at her script and an effort was made to photograph directly she looked down. Unfortunately the exposure was just too long and traces of movement have spoilt what might have been a very good result, the eyes being recorded mostly cast down, although the shutter was not quite closed when the eyes were looking at the camera. Exposure 2 secs. F/2.9 S.S. pan. Kodak film.



This picture must be one of the best known scenes to television experimenters, having been used for testing purposes by the (British) Baird Company for nearly two years. The picture is from a loop of film and the artist slowly turns her head, faces the looker-in and then with great rapidity turns her face left. The subject gives photographers a chance to know what is coming, and though the subject is never quite still, a one second exposure with a F/2.9 lens S.S. pan. Kodak film recorded the picture. In the original the scanning lines can be seen. The four faint horizontal lines are produced by the scanning disc at the transmitter, which rotates four times per picture.

equal to 1/250,000 second. On the surface these figures seem to make the photography of a television image impossible. Luckily the light of a cathode-ray tube is very intense and it is quite possible to get a printable negative with a shutter speed of one second using a suitable camera and

emulsion. Shutter speeds of 1/10 second have produced very thin negatives, while exposures of 1.5 to 2 seconds give ample exposure.

The lens must be fast, the writer uses a Dallmeyer F/2.9 Pentac lens and Kodak super sensitive panchromatic film, developed in a normal metol-hydroquinous developer.

Unfortunately, though ample exposure is easily obtained, most of the television screens contain fairly rapid movement, which produces a blurred result when adequately exposed. Few scenes televised could in the ordinary way be photographed much more slowly than 1/10 of a second without blurr, so one is rather limited to subject from an ordinary transmission and much patience is required to get a satisfactory picture. Often announcers are comparatively still at the beginning or end of a transmission. The same applies, though to a lesser extent, with artists. Sometimes test transmissions are made when somebody sits in a chair reading for some minutes on end. There is definitely much luck in choosing the right time to expose.

Another big factor in successful television photography is the brightness at which the cathode-ray tube is operated. Obviously the brighter the tube the shorter the exposure. If the brightness of a tube is increased, the picture appears, to the eye, to become flat. The shadows are lightened but the high lights do not get proportionately brighter so the gamma is reduced. This is desirable from a photographer's point of view, as the average television picture is generally tonally distorted (if in no other way).

The three prints of a B.B.C. caption card transmitted prior to the opening of the station clearly illustrate the effect of adjusting the picture brightness. The third would produce the best setting for photographing average scenes, although for a caption a strong contrast is best.

There is also another problem in photographing a television image which must be mentioned, namely, synchronization. Modern high-definition television is synchronized to a high degree of perfection, when the eye is the judge, but over periods of, say, two seconds quite a lot of unsteadiness is sometimes noticeable in a receiver as seen by a camera. So that when the artist is still, with ample exposure and sharp focusing, and the result is blurred, unsteady synchronism was probably the cause. A good photograph of a television image should show the scanning lines on close inspection.

Earlier it was mentioned that in the Marconi-E.M.I. system the scanning is interlaced. Sometimes receivers do not interlace properly, with the result that the scanning lines are very clearly marked, definition is reduced, but generally speaking photographically the intensity is doubled. In such a case the picture appears apparently more exposed than others for a given exposure.

Those who use electronic exposure meters will find that the more sensitive type will give a reading of the average cathode-ray tube of such an order as to indicate an exposure of about one second at F/3 with an H. & D. speed of 1,000. The colour of the light, of course, plays an important part, the greenish tubes are more actinic than the black and white or sepia tubes. This apparent increase in actinic value may, of course, be due to "afterglow" of the fluorescent screen, which will naturally increase the exposure in some cases quite a considerable amount, and in every case increases the apparent exposure to some extent.

We hope photographers will attack the problem with renewed vigor, as good photos of television images are scarce.—R. C. Hanner in *Television and Short-Wave World* (London).

## The Best "BUYS" Are Made For Cash!\*



\*By "CASH" we mean your jobber's regular rates.

THERE is satisfaction as well as profit in doing business in a hard-headed way—buying on regular terms rather than getting into "tanglefoot" deals. RAYTHEONS were never sold by depression methods—that is one of the reasons why RAYTHEON sales are increasing every month. Another important reason is the uncontested high quality of RAYTHEON tubes.



ASK YOUR RAYTHEON JOBBER



445 Lake Shore Drive, Chicago, Illinois  
555 Howard Street, San Francisco, Cal.  
420 Lexington Avenue, New York, N. Y.  
55 Chapel Street, Newton, Massachusetts  
415 Peachtree Street, N. E., Atlanta, Ga.

Please mention SHORT WAVE & TELEVISION when writing advertisers



# The Spitz Flight Recorder

(Continued from page 216)

Cardwell Condensers are equally well accepted by new and advanced amateurs, commercial radio services and all governmental departments using radio equipment.

## ANOTHER NEW CARDWELL

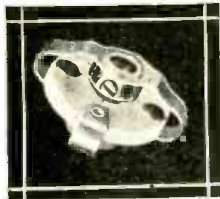

### A FLEXIBLE INSULATED COUPLING

**TYPE "A"**—Fits all 1/4 inch shafts. Diameter of Isolantite ring 1 inch. Thickness 1/8 inch. Extraordinary flexibility due to improved type phosphor-bronze surings. Reversed hubs minimize space required. Rugged construction with swaged hubs and eyeletted springs insure permanent strength. Case hardened steel cup set screws provide permanent "non-slip" hold on shafts. Net price... **\$0.35**

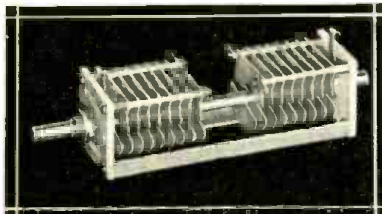

**ET-30-AD**—NEW Dual Midset. Capacity 30-30 mmfds. Airgap 0.70 inches. Isolantite insulated, 2500 volts. For 5 meter transmitters of medium power. Net price... **\$2.16**

Send 3c in stamps for the new Cardwell catalog No. 40 which includes 3 homograph charts for determining the proper condenser for any amateur frequency, power or use.

**THE ALLEN D. CARDWELL**  
MANUFACTURING CORPORATION  
89 PROSPECT ST. BROOKLYN, N. Y.

## GOOD RESULTS Demand GOOD INSTRUMENTS



TRIPLETT manufactures a complete line of measuring instruments for radio, electrical and general industrial purposes both standard and custom built. . . . For better short wave work, write for catalogue.

New Modernistic Square Instrument

Triplett Electrical Instrument Co.  
289 Harmon Ave.  
Bluffton, Ohio



## CRYSTAL HEAD PHONES

### "TRANSFILTER"

Information on request

**THE BRUSH DEVELOPMENT CO.**  
3326 PERKINS AVE., CLEVELAND, OHIO

**6 BACK NUMBERS 70c**  
SHORT WAVE & TELEVISION  
MAILED PREPAID

For a limited time only, and as long as they last, we will send you six back numbers of SHORT WAVE & TELEVISION and SHORT WAVE CRAFT assorted, your choice, for 70 cents.  
We accept U.S. stamps, U.S. coin, or money order. Rush your order today.

**SHORT WAVE & TELEVISION**  
99-101 Hudson Street New York, N. Y.

scale map of the airways are thousands of wires, arranged in circles, allowing the skipping lights to travel in any direction, two degrees at a time. Over three thousand tiny lights blink the signals of the several routes.

An automatic tuning apparatus at the ground station has several variable condensers set to correspond with oscillating frequencies of several individual planes in flight, which will enable officers in a ground or control station to direct an entire squadron in maneuvers. The sound is amplified and passed through two recording instruments perfected by Dr. Spitz, which control the lights.

One is the "binaural selector" which discloses the direction of a ship's flight by means of a series of revolving coils. The other, the "divergence wave meter," a sensitive short-wave cathode tube which determines within a single degree the distance of the plane from its control station. It is the combined operation of these two remarkable devices which establish the exact direction and distance of a plane, that the series of lights is controlled.

The possibilities of the flight recorder are almost unbelievable. Besides preserving flying schedules for commercial aircraft, there is control of naval planes from their aircraft carriers; naval officers—on a similar map—could spot the approach of submerged enemy submarines, and could thus visualize the coming of swift destroyers in heavy fog or of other surface craft in the darkness. If in time of national invasion our defense departments could watch, on another such map, the progress of hostile air squadrons across the Atlantic or the Pacific, they could know precisely the number of planes flying toward our shores and exactly where to contact them with defense craft. This equipment would afford no less than a magic mirror of the heavens and the seas at the disposal of our country for the safety of air transportation and to our national security. These things are a near possibility, by the simple process of installation of the flight recorder in all strategic areas, to cover the entire nation and our borders.

Dr. Spitz has long been a foremost authority on sound vibration. The list of inventions after his name in *Who's Who* is a long one. He designed the "Spitzscope" for reproducing images on shipboard, the wireless electric iron, the heating log, special portable radio set designs, new type Selenium cells, and many X-ray and surgical appliances. His flight recorder has taken three years of concentrated study and experiment to bring about the intricate creation that will be welcomed by the aircraft industry, the men who fly the planes, and the public who want safety as well as speed in their air transportation.

### Directional Antennae System of Dr. Spitz's Flight Recorder

(1)—The four antennae have a directional pattern of a heart-shaped type,

which results in a signal strength variation from maximum to minimum that is in direct proportion to the angle of reception over 180 degrees rotation for each antenna.

The four antennae are installed at the four points of the compass, North, South, East and West, with a reflector at the apex of the four antennae.

(2)—The output of the four antennae is fed to four phasing coils, by means of impedance matching transformers and concentric transmission lines.

The phasing coils are so arranged that the coefficient of coupling varies from minimum to maximum through 180 degrees of rotation.

(3)—The rotating section of the four phasing coils are mounted to rotate as a unit on a common shaft.

The coefficient of the coupling of the phasing coil that is connected to the antenna that is in the North position, has a maximum of coupling at the time the phasing coil that is connected to the antenna in the South position has a minimum of coupling.

The phasing coils connected to the East and West antennae have their coefficient of coupling in the same manner as the North and South antennae, with respect to one another.

The relationship between the phasing coils that are connected to the North and South antennae, to those that are connected to the East and West antennae, is such that at the time when the North and South phasing coils have their coefficient of coupling at a maximum and a minimum respectively, the phasing coils that are connected to the East and West antennae have a coefficient of coupling of fifty per cent of their maximum value.

When the four phasing coils rotate, a position of maximum signal strength results over a total of 360 degree rotation. In direct relation to the compass position of the unit that is emitting a radio frequency signal at a point distant to the above mentioned phasing coils, and associated units.

(4)—The output from the four phasing coils is fed to four isolation amplifiers, and the common output of the four isolation amplifiers is fed to an impedance-matching transformer that is coupled to a concentric (co-axial) transmission line, which in turn transfers the energy received to a radio frequency amplifier, where the radio frequency energy is rectified and filtered. The resulting D.C. voltage is fed to the control grid of a D.C. amplifier in a positive polarity, which neutralizes the negative bias potential on the control grid of the D.C. amplifier, which in turn results in an increase of plate current, that in turn causes an ammeter to have a deflection that is in proportion to the radio frequency energy received by the combination of the directional antennae system, isolation amplifiers, radio frequency amplifiers and associated component units.

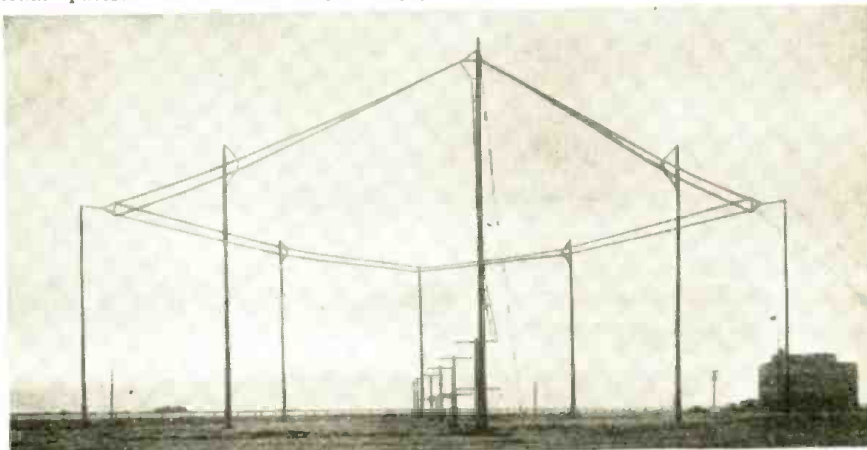

Aerial System used for Spitz Flight Recorder.

Please mention SHORT WAVE & TELEVISION when writing advertisers



# Weather Forecasting by Short Waves

(Continued from page 220)

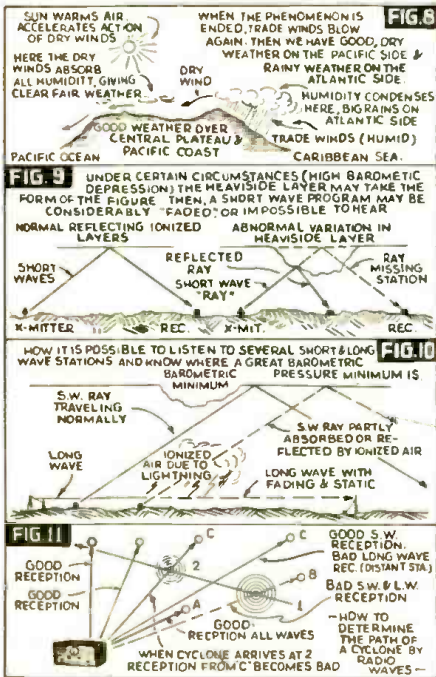

humidity to produce slight rains and a cloudy sky, and we'll have rain over all of the country, as shown in Fig. 6.

## S-W Weather Forecasts With Small Error

Consider a typical cyclone's trajectory to be as in Fig. 7, and the influence over the weather in Central America will be seen to be extensive. When the hurricane is ended the trade winds will blow again and the bad weather also come to an end on the Pacific side, but begins on the Atlantic side, (see Fig. 8). Knowing all this, it is only necessary to know when, where and how a cyclone is occurring in order to be able to forecast the weather within an error of 10%, more or less, and this forecasting becomes possible simply by listening on a short-wave radio set and making a brief study of a map, as we shall see.

We know that great changes in barometric pressure affect the height and density, (electron density) of the ionized layers. Therefore, pressure changes influence short-wave communication more or less, (see Fig. 9); thus we are able to tell when there is a cyclone occurring between a certain radio transmitter and the listener, (see Fig. 10). Let us assume that long radio waves travel over the surface of the earth, and suffer a series of successive diffractions; at least this effect is sufficiently correct for our purposes. We will assume also that the short-waves are reflected as shown in the figures, but in truth they are refracted many times and experience several changes in their velocity.

We can point out or map the cyclone's trajectory simply by listening to different short- and long-wave stations, (see Fig. 11). When the cyclone is between transmitter "C" and the listener, it would be difficult to pick up the program transmitted from "C," due to high ionization in the lower parts of the atmosphere, but stations located between the cyclone and the listener will be heard all during this time with good volume, and without any unusual disturbances. Very distant stations will not suffer at all, because their waves will be reflected at a point far removed from the barometric disturbance. Thus, by suitably interpreting radio reception it becomes possible to prevent damage to cities, towns, and farming communities by giving due advance warning.

## Eight Year's Observations

This theory would seem to hold true for the reason that careful radio observations made over a period of nearly eight years prove the points mentioned. It should also be possible for short-wave listeners to observe the occurrence and trajectory of Caribbean Sea cyclones from the United States in a similar way. Here in Costa Rica, when we have no Caribbean hurricanes, we have no big rains, which are called "temporales." (In 1930, no Caribbean cyclones, no big rains. In 1934, the same conditions. On the other hand, 1933 was noted for tremendous rains; and a long series of hurricanes took place over the Caribbean Sea.)

As an illustration of the way in which these radio observations are made, let us take the big barometric disturbance of August 1933 which caused many deaths and great destruction over a vast area with losses amounting to several million dollars. (Refer to Fig. 12.)

On August 28th, the fading was noticeably severe for English stations operating on short waves. It was impossible to pick up the long-wave (800 to 2,000 meters) stations located in England and France. The ionization of the lower layers of the atmosphere was sufficiently great to "cut out" all of these communications. The big barometric minimum was located between Port Limon and Jamaica. On the morning of August 29th, TILCR, a broadcast station operated by the author in the college where he was a professor, announced that a big cyclone had originated in the Caribbean

waves coming from the U.S.A. (North American Continent); the Caribbean's terrific hurricanes which come over from the sea, and which frequently prove so disastrous to Columbia and Florida. Let us first study the actions of the hurricanes which originate in the Caribbean Sea, and follow them via radio.

When the equator's calm zone moves northward and reaches Costa Rica, we have the pressure distributed over the country as shown in fig. 3; and we find rain areas on both sides of the isthmus, with almost no wind—the drawing is self-explanatory. Then we have the rainy season, but if—for reasons known to students of meteorology—a cyclone takes place in the Caribbean Sea and a hurricane begins, then the pressure distribution will be more or less like that shown in Fig. 4.

If the barometric disturbance is of sufficient strength, the air currents from the Pacific side will go to the Atlantic side, carrying humidity with them that will condense and produce rain on the central plateau (Fig. 5). However, unless the disturbance is exceptionally strong, the air currents will arrive in a dry condition on the Atlantic coast. Thus, while the Pacific side of the isthmus will have heavy rains, for example, the Atlantic side will have clear dry weather. If the phenomenon is sufficiently strong, the Pacific air currents will arrive at the Atlantic coast with sufficient

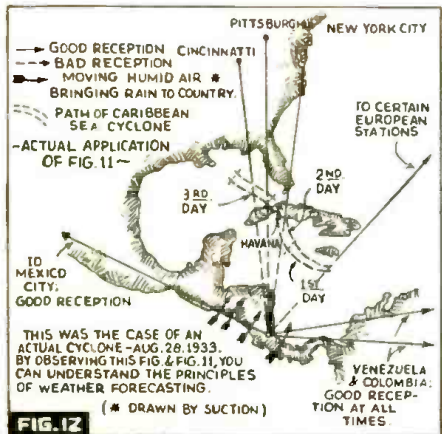

★ **SENSATIONAL AMERICAN AND FOREIGN RECEPTION**

**FOR ONLY \$2295**

**IN THE NEW 1938 CROSLEY FIVER**

★ ★ ★ **CROSLEY INTRODUCES 2 ADVANCED FIVER MODELS**

- UPRIGHT TABLE MODEL
- COMPACT TABLE MODEL



The famous Crosley Fiver ... completely re-designed, with Foreign Reception, beautiful new Crosley Micro-Dial, and modern cabinet styling. More than ever "The World's Greatest Radio Value!" Dimensions: 12 1/2" high, 10 3/4" wide, 6 1/4" deep.

• COMPACT TABLE MODEL

The same Fiver in the popular compact type cabinet. Embodies all the outstanding features and same chassis as the regular Fiver. Is identical in performance, receiving both foreign and American broadcasts. Dimensions: 8 1/2" high, 13 3/8" wide, 6 1/4" deep.



5-tube Superheterodyne; 2 bands, 540-1725 Kc. and 5800-15,400 Kc.; 5" full floating, moving coil Electro-dynamic speaker; full vision, illuminated, 3-dimensional Micro-Dial; automatic volume control; power supply noise filter.

**THE CROSLEY RADIO CORPORATION**  
 POWELL CROSLEY, Jr., President  
 Home of "the Nation's Station"—WLW—  
 500,000 watts—70 on your dial.

**YOU'RE THERE WITH A CROSLEY**

Please mention SHORT WAVE & TELEVISION when writing advertisers



# RADIO INSTRUCTION

**"LET ME TRAIN YOU at home FOR A GOOD RADIO JOB"**



**Get in Line for Big Money**

A. G. Mohaupt, General Instructor. Radio is growing fast. Modern receivers require thoroughly trained experts for service and maintenance. You can become such an expert right at home... through R. T. A. methods and begin earning money almost from the start of your course. In a very short time you will!

**Be the ONE Man in 1,000**

who understands everything there is to know in order to give quick "sure-fire" service to all kinds of receivers. You can be the one man who can take the service business away from the old-time radio "tinker."

**No Experience Needed**

Even though you know nothing about Radio now, you can quickly qualify the R. T. A. way to step right into a well-paying position—or start your own profitable business. Use your spare time and

**LEARN AT HOME**

Most R.T.A. members start making money right from the beginning. The special servicing equipment which is supplied without extra cost makes this possible. Don't wait—start now. Write today for our interesting Radio Book FREE.

**Don't Put It Off—Send Coupon Now**

**RADIO TRAINING ASSOCIATION OF AMERICA**  
4525 Ravenswood Ave., Dept. SW-79, Chicago, Ill.

RADIO TRAINING ASSN. OF AMERICA  
Dept. SW-79, 4525 Ravenswood Ave., Chicago, Ill.  
Gentlemen: Send me details of your Enrollment Plan and information on how to learn to make real money in radio quick.

Name .....

Address .....

City ..... State .....

## LEARN CODE RIGHT

Tapes for Every Need—Even Airways—Send you Typical Messages by INSTRUCTOGRAPH.  
It's easy and practical to learn or improve your Radio or Morse Code, any speed. Sander model with 10 tapes and Book of Instructions—\$20.25. (Sent at low cost.) Junior model with 5 tapes and Book of Instructions—\$12.00. (Not sent.) Complete Operator equipment, less battery, \$20.00. Send for details today to—

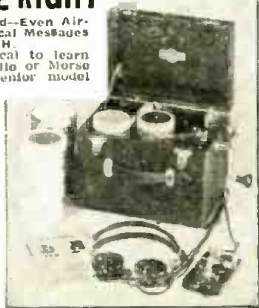

**INSTRUCTOGRAPH CO.**, Dept. SW 9  
912 Lakeside Place  
Chicago.

Canadian Representative: Radio College of Canada, 863 Bay St., Toronto.

WE ALSO HANDLE: HALLICRAFTER and R.M.E. SHORT-WAVE RECEIVERS—MICROPHONES—VI-BROPLEXES—TAYLOR TUBES. CASH OR TERMS.

## RADIO COURSES

**RADIO OPERATING:** Prepare for Gov't License Exam. ● **RADIO SERVICING:** Including Short Wave ● **AMATEUR CODE** ● **ELECTRONICS** ● **TELEVISION:** Day and Evening Classes. Booklet Upon Request.

**New York YMCA Schools**  
6 W. 64th Street, New York City

# RADIO ENGINEERING

broadcasting, aviation and police radio, servicing, marine radio telegraphy and telephony, Morse telegraphy and railway accounting taught thoroughly. Engineering course of nine months' duration equivalent to three years of college radip. work. All expenses low. Catalog free. School established 1874.  
Dodge's Institute, Turner St., Valparaiso, Ind.

Sea. The author explained to the public via radio the danger of great rains over all of the country, and many of the farmers that listened to the broadcast warning took precautions and managed to save their products from being damaged by the great "Temporale."

The cyclone moved toward Cuba, as indicated by the static heard on the long waves, which gave the effect as if it were receding in strength or going away to a distant point. Also it now became possible to receive the English stations fairly well, while the fading of these stations became less and less noticeable. On August 30th, it became impossible to pick up Cuba, which was very near the cyclone; stations located in San Antonio, Texas, and Mexico were clearly audible.

Poor reception on long waves of stations in New York and Pittsburgh became noticeable, due to electrical disturbances in the lower atmospheric layers, and on short waves, (caused by reflection of the short-waves at a point near the disturbance) this effect indicated that the cyclone was now over Cuba. Actually, the great hurricane passed over Havana on August 31st. At this time reception of Pittsburgh and Cincinnati stations on long waves was almost impossible. On short waves it was impossible to pick up these stations due to the great fading. Some were able to listen to Cuba again, but now we found that new stations suffered from fading as the cyclone moved along north-westward. But all during this time we heard perfectly stations located in Mexico, California, Colombia, Venezuela, and even Argentina—all of them located well out of the hurricane's path, or not forming a straight line with the cyclone and the listener's location.

The effects of that disturbance were disastrous to Costa Rica and Central America, because of the great rains. But the "weather forecasting" via short-waves was a success and distinctly aided in saving life and property. Here are suggestions for listeners in the United States: Observe the conditions under which you obtain stations in Cuba, Colombia, Venezuela, Costa Rica, and in general, South America. As people in the states have a good meteorological service, study the path of barometric pressure minimums in the same way as the author observed the Caribbean cyclones. After a little practice you will be surprised how you can follow all major barometric disturbances and by knowing the effect they produce on your local weather conditions you will be able to make some surprising weather forecasts.

Some of the experiments conducted by the author have shown that a barometric high pressure area can be followed in a similar manner to that already explained, and in a further article I hope to have the pleasure of explaining this phenomenon. This method of forecasting the weather by variations in short- and long-wave reception presents a new field of experimentation and one which is certain to be of great future importance. Anyone interested in further details may write to the author enclosing a stamped self-addressed envelope and he will be glad to advise them. Address, Lic. J. Merino y Coronado, 150 S. de La Tranquillidad, San José, Costa Rica.

variations caused by "storm centers," such as pointed out in the foregoing article.

The whole theory is now complete for the Doctors Colwell and Friend have found that the new (reflecting) C-Layer varies its height with changes in the barometric pressure and other weather conditions. When the barometer is high for example, the altitude of the C-Layer above the earth is low, and vice versa. The variations in the height of the C-Layer is also very marked, passing through a variation of from 1 to 15 kilometers. (From 0.6 to 9 miles).

As these scientists point out in their report, this discovery promises to provide a valuable new means of forecasting the weather at least 24 hours ahead.

Students of the subject will see from this report, that if the C-Layer, for instance, changes its elevation from time to time as the barometer and other weather conditions change, the strength of signal from a certain short-wave station will change in strength also, the skip distance changing between the transmitter and the listener. In the extreme case—with the C-Layer high above the earth—the reflected short wave may be reflected back so as to entirely miss a listener who had been receiving the signals or program on that wave possibly an hour or so before, when the C-Layer was at

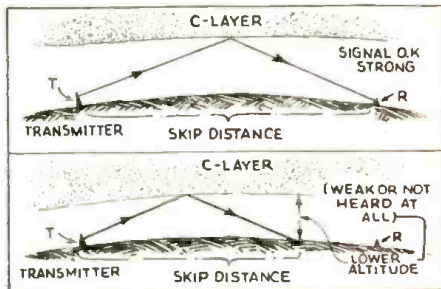

How variation in altitude of reflecting layer causes signal reception to vary also.

a lower altitude. Likewise, if the C-Layer should lower its altitude markedly, the reflected signal will now exhibit a shorter skip distance, and the signal may again miss a given listening post which had been receiving the signal clearly a few hours before, because of the higher altitude of the C-Layer.

Of course, in making a complete study of the various atmospheric reflecting layers, now cataloged and labelled by our radio experts, it becomes necessary to remember that we will have reflected signals coming down to earth from other layers than the C-Layer. But, regardless of this fact and the various reflections from different layers, the main basic principle of the new theory of weather forecasting via short waves has been set forth, and it is also undoubtedly true that more or less variation in altitude occurs for the other reflecting layers as well as the C-Layer.

Therefore, variations in the reflected signals or waves will occur with the other layers as well, and the whole action will be seen to "tie in" with the new analysis propounded by Drs. Colwell and Friend.

### Editor's Note:

While the foregoing article may present a rather new and unfamiliar aspect to the average student of short waves, a very interesting new discovery described in "The New York Times" of April 30th gives valuable support to Professor Coronado's theory and observations on radio weather forecasting.

In the issue of the Times referred to, the discovery of a new radio reflecting layer in the troposphere known as the C-Layer was reported by Doctors R. C. Colwell and A. W. Friend of West Virginia University. Some radio students may wonder just how atmospheric changes, variations in the barometric pressure for example, may affect short-wave transmission and reception so as to enable listeners to detect

## Tuning Transmitter

(Continued from page 246)

a change in grid current. The final amplifier dial should now rest at the point where this change occurred. We are now ready to apply the plate voltage of the final amplifier and adjust the plate condenser to minimum plate current. The antenna is then coupled to the final amplifier to the extent that will cause the plate current to rise to normal operating specifications and the final touch will be to set the amplifier plate condenser for lowest plate current. This, of course, is the procedure with conventional tuned antenna; not with the Collins impedance matching device.

Please mention SHORT WAVE & TELEVISION when writing advertisers



## A.B.C. Beginner's Short-Wave Set

(Continued from page 222)

means of a knob, the tickler coil can be turned through an angle of over 180 degrees, so that the direction of its windings can be completely reversed with respect to that of the secondary windings. The secondary, consists of 100 turns of No. 28 d.c.c. (double cotton covered) wire. The same size wire is used on all the windings. The secondary is tapped at two points, as indicated on the schematic diagram. It is tuned by a .00014 mf. variable condenser. Connections are made from the taps to four clips, shown at the lower part of the panel in a semi-circle. A flexible wire connection from the grid terminal of the variable condenser, permits the use of the condenser to tune any selected portion of the coil, instead of the entire secondary. For example, if the entire coil is tuned without connecting the flexible wire to any of the two clips, the receiver will bring in stations on the broadcast band. By connecting the flexible lead to clip No. 1 and cutting out 20 turns, stations on the upper police (180 meters) band will be received. By connecting the flexible lead to Clip No. 2 and cutting out a total of 40 turns, the set will bring in amateur and lower wave-length (120 meter) police calls.

This set is intended mainly for experimental purposes, since the efficiency of a tapped secondary such as the one used, drops considerably on wavelengths below 100 meters.

An antenna-trimmer is provided in the antenna circuit as shown at "C1." This may be adjusted by means of a screw-driver, or a shaft may be soldered to the adjusting screw, permitting the use of a knob. The antenna trimmer is of considerable help in tuning in short-wave stations. The filament rheostat is provided to keep the filament voltage constant as the "A" batteries become weaker. The .0001 mf. condenser C3 is known as the grid condenser. R1 is the grid-leak.

Regeneration is controlled by rotating the tickler. As this is turned very slowly, station whistles will be heard. After proper adjustment, the stations will come in clearly, as the tuning condenser is turned.

In assembling the "A.B.C." receiver, fasten the panel to the side supports by means of wire brads. Then, mount the coil, antenna trimmer and variable condenser beneath the panel. The socket may be mounted above or below the panel as desired. The ten clips are fastened above the panel. Next proceed with the wiring, in the following order,—first complete all "A" plus and ground connections; next "A" minus, then grid and plate circuits and finally, wire in the condensers C4 and C5. Check over the wiring carefully, then connect the "A" battery and see whether tube lights up. Remove tube, connect "A" and "B" batteries, earphones, antenna and ground, insert tube and the set is ready for test.

This receiver gives surprisingly good ear-phone volume. By increasing the "B" voltage, it will even operate a small magnetic speaker, on the stronger stations. The entire receiver can be built in an hour, even by an inexperienced person and its low cost matches its simplicity.

### List of Parts for the "A.B.C." Beginners' Short Wave Set

- HAMMARLUND**  
 C1—Equalizer Antenna Trimmer, type MICS (10 to 70 mf.)  
 C2—Midjet Condenser, 140 mmf., type MC-140-M
- CORNELL-DUBILIER**  
 C3—.001 mf. mica condenser, type 3L  
 C4—.00045 mf. mica condenser, type 1W  
 C5—.02 mf. either mica or "CUB" type tubular condenser
- ELECTRAD**  
 R2—Electrad Filament control rheostat, 30 ohms, type 270-W
- I.R.C. Resistor**  
 R1—1 meg. ½ watt metallized resistor
- KAYTHEON**  
 Tub—Raytheon, 1-30 type

# RADIO INSTRUCTION

*You've got what it takes to be a Speedy Operator!*

—all you need is

## CANDLER TRAINING



Right now you have the capacity of sending and receiving code as easily as you talk and listen. Walter Candler knows how to develop your sound consciousness so that your sending and receiving senses will work automatically. You will be amazed at your progress with CANDLER instruction! CANDLER methods are so easy, so interesting—that code skill will just come to you naturally. Almost before you realize it, you will be "pounding brass" with the best of them, and taking it as fast as they can send it! Look what the World's Champion Radio Operator, T. R. McElroy, says about learning Code

RIGHT, and acquiring skill—

"Practice alone, with any kind of practice set, will not develop a skilled operator. It takes a thorough knowledge of the Fundamentals and Mind Training taught exclusively by the Candler System."

The only difference between you and a skilled radio operator is the coupon below. Mail it today. Walter Candler, maker of champions, will do the rest! Save time and money by learning code and acquiring skill the Candler way!

## CANDLER SYSTEM CO.

Department SW9

Asheville, North Carolina, U. S. A.

Candler System Co.  
 Dept. SW9, Asheville, North Carolina, U. S. A.  
 Send at once the FREE BOOK OF FACTS. This does not obligate me.

Name \_\_\_\_\_  
 Address \_\_\_\_\_  
 City \_\_\_\_\_ State \_\_\_\_\_

## \$100 for a RADIO KEY!?

**WORTH IT—but I only charge \$9.50**

This semi-automatic key makes it easy to send! Dot stabilizer equipped. Selected main-spring. Marlette finish base stays put. Chromium metal parts. Proper height for tireless, rhythmic sending. New 1938 Mac Key only \$9.50. Order today! Also New Mac Straight Key—best ever—only \$9.50. Write for complete details on other Mac items of tremendous help to radio ops.

T. R. McELROY—175 Congress St., Boston, Mass.  
**WORLD'S CHAMPION TELEGRAPHER**

## LEARN RADIO TELEVISION

Color-Coded Extension Training fits you for better radio jobs—prepares for future television opportunities. Backed by 600-watt Columbia basic network broadcasting station, KABC. Graduates qualified to take Government operator's license exams. Lifetime employment service. All necessary equipment for "home laboratory" experiments furnished; 90 illustrated lessons, 10 laboratory manuals. After "home training," bus ticket to Kansas City for 4 weeks' intensive training in laboratories. Get facts—write for free catalog.

MIDLAND TELEVISION, Inc., Power & Light Bldg.,  
 112 W. 14th St., Kansas City, Mo.

## RADIO ENGINEERING

RCA Institutes offer an intensive course of high standard embracing all phases of Radio. Practical training with modern equipment at New York and Chicago schools. Also specialized courses and Home Study Courses under "No obligation" plan. Catalog Dept. SW-37.

**RCA INSTITUTES, Inc.**  
 A Radio Corporation of America Service  
 75 Varick St., New York, 1154 Merchandise Mart, Chicago

Get into  
**RADIO**  
REAL JOBS  
REAL PAY

Earn While Learning at Home!  
**TELEVISION, PHOTO ELECTRIC CELLS, PUBLIC ADDRESS**  
 Many R-T-I Trained Men make up to \$75 a week and more in full-time Radio jobs—\$2-\$16 in spare time alone. More trained men needed. Learn at home by mail, easy R-T-I WAY. Endorsed by 50 big consumer magazines. Write for big Opportunity Book FREE.  
**RADIO AND TELEVISION INSTITUTE, Inc.**  
 2130 Lawrence Ave., Dept. 216, CHICAGO, ILL. R-T-I

**PHILCO  
 CROLEY  
 ZENITH  
 GRUNOW**  
 and 46 other mfrs. endorse

### MISCELLANEOUS

- Socket, 1—four prong socket  
 1—Find-All Air-Core Antenna Coupler with rotatable tickler  
 10 Fahnestock connection clips  
 Two dials  
 1—8½x11" panel, wood or bristol board  
 2—Sloping wood side-supports, 3" high x 10½" long  
 Hook-up wire, knobs, etc.
- BATTERIES**  
 2—1½ volt "A" dry cell batteries, either flashlight type or No. 6 type  
 1—22½ volt "B" battery
- CANNON-BALL**  
 Earphones—sensitive type

## READ and SEND CODE

Learn Easily At Home This Quicker Way

No experience needed. Beginners read code quickly, copy accurately. If already an op., speed up your wpm with this approved amazing all Electric Master Telex Code Teacher. Only instrument ever produced which records your sending in visible dots and dashes on specially prepared paper tape then sends back your own key work at any speed you wish. Fascinating, fool-proof, gets results because you learn by HEARING as well as seeing. That is why thousands agree this method is surest and quickest. We furnish Complete Course, lend you the New All Electric Master



Telex, and personal instruction with a MONEY-BACK GUARANTEE. Low cost, easy terms. Write today for folder S-9, no obligation.

### TELEPLEX COMPANY

72-76 Cortlandt St., NEW YORK, N. Y.

## RADIO ENGINEERING TRI-STATE COLLEGE DEGREE IN 2 YEARS.

Complete Radio Engineering Course in 96 weeks. Bachelor of Science Degree. Radio (television, talking pictures and the vast electronic field) offers unusual opportunities for trained radio engineers. Courses also in Civil, Electrical, Mechanical, Chemical, Aeronautical Engineering; Business Administration and Accounting. Low tuition, low living costs. World famous for technical two-year courses. Those who lack high school may make up work. Students from all parts of the world. Enter September, January, March, June. Write for catalog, 2597 College Ave., Angola, Ind.

*Learn* **SOUND RECORDING**  
**TALKING PICTURE PROJECTION**  
**TELEVISION-RADIO**

Master training courses qualify you for good jobs. Practical, easy to learn. Newest equipment. Established 1905. Each room and board, while learning. Send for FREE catalog to L. A. Write for FREE BOOK. Address Dept. 9-SWC, 4000 S. Figueroa St.

**NATIONAL SCHOOLS—Los Angeles**



H. G. CISIN'S All-Wave Air Scout Jr. Radios

# THREE-TUBE \$3.20

WITH PHONE Less Tubes Unwired

## ALL ELECTRIC ALL WAVE SET

MODEL 3A-E

A powerful sensitive all-wave set. Holds wonderful records for foreign reception. Also brings in police calls, amateurs, code. Transatlantic phone and broadcast entertainment. Excellent volume. Works from any A.C. or D.C. house current. Easiest set to build. Employs newest metal ballast tube. Speaker mounts on attractive panel. Range 8 1/2 to 610 meters or to 2000 meters with special long wave coil. Complete kit includes: Earphone, broadcast coil, 70 to 200 meter coil. Panel (two styles available, painted or rectangular iron). Chassis, High Grade Variable Condenser, Potentiometer, Antenna Trimmer, Dial, Sockets, Knobs, Wire, Resistors, Condensers, and all other required parts including instructions and diagram. With Phone Less ONLY \$3.20 (tubes unwired)

Following Auxiliary Parts are available: 8 1/2 to 20 meter coil 25c; 15 to 45 meter coil (foreign) 25c; 40 to 80 meter coil (foreign) 25c; long wave coil and 1 1/2 unit (to 2000 meters) \$1; Band Spread Attachment 75c; 3" Find-All Loud Speaker \$1; Double Earphones \$1.50; Set of 3 matched tubes \$1.95; Wired Extra 75c.

**NOTE:** If you already have earphones, two extra for. 45m coils may be substituted.

---

### BEGINNERS ABC KIT

1-Tube

**SPECIAL:** Complete Kit of BEGINNERS ABC Receiver, including tube, earphone, antenna wire, special coil and all other parts, hook-up wire, panel, "A" and "B" batteries—Nothing else to buy. With Phone Less Coil sold separately for \$1.25.

**\$4.20**

H. G. CISIN, Chief Eng., ALLIED ENG. INSTITUTE  
98 Park Place Dept. S-39 New York, N.Y.

# MAILING LISTS

GET OUR FREE REFERENCE BOOK and MAILING LIST CATALOG FREE



Polk's Reference Book for Direct Mail Advertising

Gives counts and prices on accurate guaranteed mailing lists of all classes of business enterprises in the U. S. Wholesalers—Retailers—Manufacturers by classification and state. Also hundreds of selections of individuals such as professional men, auto owners, income lists, etc.

Write today for your copy

# R. L. POLK & CO.

Polk Bldg.—Detroit, Mich.  
Branches in Principal Cities

World's Largest City Directory Publishers  
Mailing List Compilers, Business Statistics, Producers of Direct Mail Advertising.

# ELECTRIC PENCIL

AN electric tool that embosses on leather, wood, silk, paper or other material. Writes like a pencil.

The writing can be embossed in any of the five following colors: Gold, Silver, Red, Green, Blue.

A roll of colored foil of each of these colors is furnished with the outfit. Cord and plug is included in the box. Also 4-page instruction booklet. Plugs into any electric outlet, A.C. or D.C. 110 volts. Amount of current used is negligible. Very useful to anyone wanting to emboss books, wooden objects, leatherware, fabrics, Radio panels, hat bands, stationery goods, gifts, tools, instruments, etc.

Size of writing tool 6". Size of box containing outfit 10"x8 1/4".

STOCK NUMBER: S204 ELEC. TUBE EMBOSING SET. YOUR PRICE **\$2.27**

Sent postpaid anywhere in U. S. A. Money back guarantee

**WELLWORTH TRADING CO.**  
Dept. SWT-937  
560 W. WASHINGTON BLVD., Chicago, Ill.

# Home-Made Recorder

(Continued from page 221)

the purpose. The magnet operating the pen may be of quite low resistance, such as that obtained from a bell or other device and is operated from a 4 1/2 volt battery. The local circuit through the pen magnet is opened and closed by silver or other contacts actuated by a high resistance relay. In the article referred to, this relay was made from the field-magnet of an old dynamic speaker. The moving coil, for relay purposes, was especially made by winding 1,500 turns of No. 42 enameled wire on a form made of thin fibre or paper, shellacked to hold it in shape. The magnet winding on the speaker field frame is excited from any convenient source of D.C. The original author used it as the filter choke in his receiver power-pack.

A very soft lead pencil may be used for recording; if an ordinary fountain pen is to be used this should be arranged to strike the paper at a very slight angle.

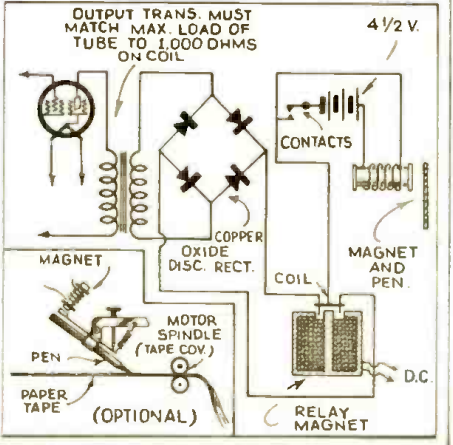

# Let's "Listen In" With Joe Miller

(Continued from page 236)

14090; ZS5AB, 14060; ZUGP, 14110; ZS6AJ, 14330; ZS2X, 14030; all in South Africa, lately reported by Ashley Walcott, between 8:15-10 a.m.

ASIA

XU8JR, "Japan Radio," 14130, China; J7CR, "Canada, Russia," 14265; J7CJ, in Hokkaido, 14350, also in Japan reported by Ashley Walcott between 8-9:30 a.m. on West Coast.

Also reported heard are VS7AK, 14005, Ceylon; VU2DP, 14005, India; MX2B, 14310, Manchukuo; J2KJ, 14280, and J2M1, 14145, with J4M1, 14310, all in Japan. Also VS6AG, 14084, in Hongkong.

Ashley Walcott reports VS6AB, 14040, and VS6AG. Also VS1AD, "America Denmark," 14350, Singapore; VS2AK, 14265, Malay States. Very FB, Ashley! Best times for Asiatics in East is near 6 a.m.

Y12BA, 14100 approximately, Iraq, was heard by Ralph Gozen at 9-9:30 p.m. with an R6 signal. QRA is given below, received by Ed Murphy, W1IFK, our Stamford Nite Owl, when Ed was in CW QSO with Y12BA. QRA: Y12BA, % Port Directorate, Basra ya Mirgil ya, Irak.

HAM DX REVIEW

GW5KJ, 14125, giving no location, heard lately at 6:45 p.m. As the British Isles are being divided into different call-prefix areas, as Scotland, GM; Ireland, GI; Irish Free State, EI, it is quite likely that this is the new prefix for Welsh amateur stations. Those hearing other GW hams may write to the QRA of English amateurs whose call corresponds to the one heard, when the letter W is omitted from call, and we feel certain a veri will be forthcoming.

Till next month, our best wishes for DX and a mailbox chockfull o' Veries! Vy 73 from Ye ED.

Joe Miller.

# SHORT-WAVE BOOKS with a WORLD-WIDE REPUTATION!

NEW YORK, N. Y. 101 HUDSON ST.

SHORT WAVE & TELEVISION, 99-101 Hudson Street, New York, N. Y., SWT-9-37

Get them now! I enclose herewith my remittance for the amount of \$..... for which please do send me, postpaid, the books checked below:

- How to Get Best Short-Wave Reception 50c each
- 101 Short-Wave Hook-ups 50c each
- How to Build and Operate Short-Wave Receivers 50c each
- How to Become an Amateur Radio Operator 50c each
- Ten Most Popular Short-Wave Receivers. How to Make and Work Them 25c each
- The Short Wave Beginner's Book 25c each

Name \_\_\_\_\_  
Address \_\_\_\_\_  
City \_\_\_\_\_ State \_\_\_\_\_  
Order by check or money order. If letter, contains cash or remittance, enclose postage stamps, postpaid (U. S.)

---

**THE SHORT-WAVE BEGINNER'S BOOK**  
Here is a book that solves your short wave problems—leading you in easy steps to the present stage of the art as it is known today. It is the only low-priced reference book on short waves for the beginner. 75 Illustrations. 40 Pages. **25c**

**10 MOST POPULAR SHORT-WAVE RECEIVERS**  
—HOW TO MAKE AND WORK THEM  
The editors of SHORT WAVE AND TELEVISION describe ten outstanding short-wave receivers. Each receiver is fully illustrated with a complete layout, pictorial representation, photograph, and complete hook-up. All are worth a little more than their cost. 75 Illustrations. 40 Pages. **25c**

**HOW TO GET BEST SHORT-WAVE RECEPTION**  
This book tells you everything you have wanted to know about short-wave reception in the amateur field. The author, a professional radio listener and radio fan for many years, gives you his long experience in radio reception and all that goes with it. 40 Illustrations. **50c**

**HOW TO BECOME AN AMATEUR RADIO OPERATOR**  
By Lieut. Myron F. Eddy, whose experience in the amateur field has made him one of the best known operators. If you intend to become a licensed code operator, if you wish to take up phone work eventually—this is the book you must get. NEW EDITION COMPLETELY REVISED. 150 Illustrations. **50c**

**101 SHORT-WAVE HOOK-UPS**  
Here is a worthwhile book that every short-wave listener, every short-wave fan, and every amateur needs. It gives you the 101 best short-wave hook-ups which have appeared heretofore. 72 Pages. **50c**

**HOW TO BUILD AND OPERATE SHORT-WAVE RECEIVERS**  
This is the most up-to-date book on the subject—edited and prepared by the editor of SHORT WAVE AND TELEVISION. It contains the wealth of material on the building and operation, not only of typical short-wave receivers, but short-wave converters as well. 150 Illustrations. 72 Pages. **50c**

Please mention SHORT WAVE & TELEVISION when writing advertisers



# An Effective S-W Pre-Selector

(Continued from page 224)

## Pre-Selector Requirements

An effective pre-selector should, as it will be largely used at the high frequencies, tune with a comparatively low C, use plug-in coils of high efficiency or a switch-band system having no-loss characteristics, employ steatite or isolantite insulating parts, and be in general designed in keeping with the demonstrated dictates of ultra high frequency constructional practice. It may or may not be self-powered, but in any circumstance it should be small, quite inexpensive, and so engineered that no loss in power will be effected in transferring the signal which it selects and amplifies to the input of the receiver.

This design of ours is really quite elementary and simplified—but it non-the-less meets requirements to a "T." It is extremely efficient, provides enormous R.F. signal gain, tunes sharply and cleanly, corrects image and signal selectivity maladjustments in the worst of receivers, and—which is highly important—features a thoroughly sound method of matching its output to the receiver. Powering voltages are obtained from the receiver or a separate "A" and "B" supply, and the coils are of the plug-in type.

## The Circuit

The circuit is adapted from the familiar tuned grid-tuned plate hook-up and requires two sets of coils for each band to be covered. Both coils—that is, both grid and plate windings—are simultaneously tuned by a "two-gang", .0001 mf. (per section) variable condenser, and peak alignment is facilitated by the adjustment of Hammarlund APC air trimmers installed within the coil forms, and wired so that they be used in parallel or in series with the tuning capacities. (The series arrangement is desirable for full dial scale spreading of limited amateur and short-wave broadcast bands).

The plate winding does not, it might be noted, carry DC, B plus to the tube plates being fed through a pie-wound short-wave choke.

This sort of scheme works out exceptionally well for pre-selector purposes and is well worth the additional cost of plate coils and the inconvenience of having to remove and replace two forms with each band-change. The tuned plate circuit places a positive load on the tubes, permits really effective amplification, and further facilitates the business of properly matching the instrument into the receiver and without signal loss. With regard to this last, it should be noted that output windings on the plate coil forms may be so adjusted, in number of turns, etc., that an exact match to receiver input coils may be effected. The windings may be made different on different coils and to match different inputs as determined by matters of individual receiver construction.

Some regeneration is, of course, desirable, and we have so arranged the placement of parts that the right amount of feedback coupling between plate coil and grid circuit is had without any necessity for a coupling device. Note that the grid cap of one R.F. tube is quite close to the plate winding.

The manually adjustable rheostat in the cathode to ground lead determines both regeneration and general gain. Two tubes, note, are employed in parallel connection, and it is suggested that the pair be used by the builder of a duplicate pre-selector. No difficulties in the way of "peak-loading" are experienced, no especial broadness of tuning is effected, and no noticeable tendency toward instability results when the two tubes are thus employed. As a matter of fact the gain is almost doubled over that for a single tube—as can be at least fairly well shown with the pre-selector in operation, by lifting one grid cap connector from

tube contact and noticing the drop in signal level.

As maximum gain and selectivity are more or less dependent upon the exact alignment of grid and plate tuned circuits at a selected frequency, some means for manually peaking these circuits is made desirable. The air-trimmers in the coil-forms do, of course, effect alignment at the high frequency limits, but precise "tracking" calls for an additional trimmer mounted on the panel and bridged across either the grid or plate tuning condensers, exact placement depending upon matters of load as they affect the tuning curves for the two circuits. Some antennas may be such that they load up the grid coil; and here the trimmer might be required across the output circuit in order to compensate for the effect of such a load. Some connections may disturb the output tuning curve, requiring use of the trimmer in the grid circuit. Proper placement will be really a matter of trial and error experiment in individual instances.

## Construction

Any small lift-cover cabinet will work out satisfactorily for this design, that used for the laboratory model being a made-up job 9" long by 6" high by 8" deep and provided with a rather shallow (1 inch high) chassis, spot-welded to the removable front panel. As constructional layout data must be referred to some particular chassis and cabinet, however, that used for the lab. model is suggested for exact reproduction by the reader.

The specified dial is small, very efficient, and certainly neat and professional looking, and is mounted on the chassis (for proper line-up with the front panel cutout) by means of its support, one-half inch of which is bent back and bolted down. The two tuning condensers are ganged together with a flexible coupler, and then mounted on stand-off insulators—with five- and ten-cent store fibre washers placed between frames and insulators until with the stand-offs fastened to the chassis the common condenser shaft lines up properly with the dial hub. Another flexible coupling is used to connect shaft and hub together, to facilitate alignment and to isolate the tuned circuit as much as possible from the grounded dial mechanism, whose bearings and wiping parts might cause tuning noises.

The two socket holes are stamped out so that the 6K7 tube grid caps will be really close to the stator terminals on the grid tuning condenser. Sockets as used in the laboratory model are suggested, not only because of their high dielectric efficiency (low power and loss factors) at ultra high frequencies, but because they take up little space and further may be positioned for shortest possible leads to associated components. (These sockets are retainer-ring mounted and will require no riveting or bolting to the chassis.)

Similar sockets mounted in the adapter plates with which they are regularly supplied are used for coil plug-in, and are elevated above the chassis by means of spacers and long machine screws until prong terminals are in the clear. (The resilient concentric retainer rings take on the full strain of repeated coil form insertion and removal and the plates the full strain of chassis mounting. This assures us against any possibility of socket breakage.)

The gain or regeneration control and the manually adjustable tracking-trimmer are mounted on the front panel, to the right and left of the dial, and a 3-terminal moulded antenna assembly and two terminal output assembly are mounted on the rear wall of the chassis.

## Wiring

Little information need be given regarding proper wiring procedure. Simply keep leads as short as conveniently possible—



# Amazingly Easy Way to Get into ELECTRICITY

Send Today for Details of

## "Pay-After-Graduation" Plan

Don't spend your life never sure of a job. Let us prepare you for your start in a good paying field. Let us teach you how to prepare for positions that lead to good salaries in Electricity—NOT by correspondence, but by an amazing way we teach right here in the great Coyne Shops. You get a practical training in 90 days. Mail the coupon below. If you are short of money I'll send you all details of my "pay-after-graduation plan" where many get my training first and start paying for it 5 months after they start school and then have 18 months to complete their payments.

## LEARN BY DOING—IN 90 DAYS BY ACTUAL WORK IN THE GREAT COYNE SHOPS

I don't care if you don't know an armature from an air brake—I don't expect you to! Coyne training is practical "learn-by-doing" training. Don't let lack of money hold you back from getting all details of my amazing plan.

## MANY EARN WHILE LEARNING

If you need part time work to help pay your expenses, we may be able to help you as we have hundreds of others. When you graduate we'll give you lifetime employment service. And, in 12 brief weeks, in the great shops of Coyne, we train you as you never dreamed you could be trained . . . on one of the greatest outlays of electrical apparatus ever assembled . . . real dynamos, engines, power plants, autos, switchboards, housewiring, armature winding and many other branches of Electricity.

## Electric Refrigeration Air Conditioning

Right now we are including additional instruction in Electric Refrigeration and Air Conditioning without extra cost so that your training will be complete and you can get into this marvelous, rapidly expanding field.

**GET THE FACTS** Coyne is your great chance to get into Electricity. This school is 38 years old—Coyne training is tested. You can find out everything absolutely free. Simply mail the coupon and let us send you the big, free Coyne book with photographs . . . facts . . . opportunities. Tells you how many earn expenses while training and how we assist our graduates in the field. No obligation to you. So act at once. Just mail coupon.

## BIG FREE BOOK

Send for my big book containing photographs and telling the complete story—absolutely FREE.

H. C. Lewis



## COYNE ELECTRICAL SCHOOL

500 S. PAULINA ST., Dept. 67-83, CHICAGO, ILL.

H. C. Lewis, Pres., COYNE ELECTRICAL SCHOOL  
500 S. Paulina Street, Dept. 67-83, Chicago, Ill.

Dear Mr. Lewis: Without obligation send me your big, free catalog with facts about Coyne Training and details of your "Pay-Tuition-After-Graduation" Plan.

Name . . . . . Age . . . . .

Address . . . . .

City . . . . . State . . . . .

advertisers

Please mention SHORT WAVE & TELEVISION when writing



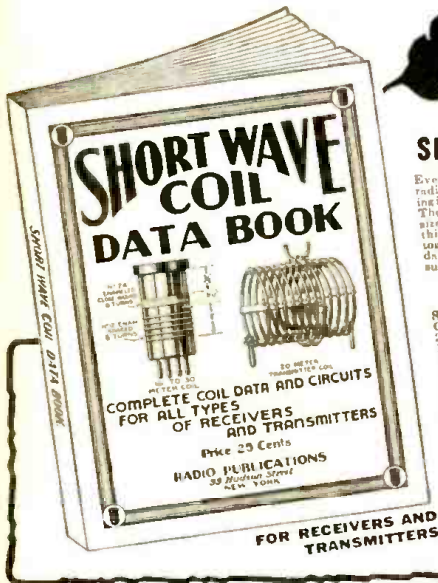

### SHORT WAVE COIL DATA BOOK

Every experimenter knows that the difference between a good and a poor radio set is usually found in the construction of short-wave coils. Coil winding information is vitally important and in the new coil book all "dope" appears. There are illustrations which give instructions on how to wind coils, dimensions, sizes of wire, curves and how to plot them. Every experimenter needs this book—it also contains complete data on all types of receiving coils, in addition with many suitable circuits using these coils. Also complete data on various types of transmitting coils with many transmitting circuits such as exciters and amplifiers using the various coils described.

#### Contents Briefly Outlined

S-W Tuning Inductance Charts • Coil Data for T. R. F. Receivers • One Tube Oscillators • Two Tube Bandspreaders • The Mono-Coil • 2-Tube Old Reliable • 2-Tube Globe Trotter • 3 Winding Coils—10-500 Meters • Doerle 3-Tube "Signal Gripper" • Electrified • 3-Tube Bandspreaders for the Ham • General Coverage Coils on Ribbed Forms • Coil Data for Superhet or S-W Converter • Ultra S-W Coils • Switch Coils for S-W Superhets • Experimental Coils • S-W Antenna Tuner • Most Popular S-W Tuning Circuits • Self-Supporting Transmitting Circuits Empirical Coils Described • All Band Antenna Tuner for Transmitting • Plug-in Coils for Exciters • Frequency-Wavelength Conversion Chart

PRICE 25c PREPAID

For a copy of this handy book, send 25c in U.S. Coin or stamps to

#### RADIO PUBLICATIONS

97 HUDSON STREET NEW YORK, N. Y.

Where  $C_1$  has a maximum capacity of .0001 mf. and  $C_2$  (the trimmer) is adjusted to say .000025 mf. maximum effective C or CS will equal

$$\frac{.0001 \times .000025}{.0001 \text{ plus } .000025} \text{ or } 20 \text{ mmf.}$$

Where  $C_1$  has a minimum capacity of .000006 mf. and  $C_2$  retains its adjustment at .000025 mf. an effective minimum capacity of 4.8 mmf. will be obtained.

The change in capacity from minimum to maximum will be approximately 5 mmf.—sufficient for wide scale bandspreading of 28 mc amateur phone stations and more than full scale spreading for the complete 14 mc. band. The actual variable C in the circuit will not be sufficient for complete coverage on lower frequency bands, however, and series trimmers for coils used on such bands must be adjusted for a much wider range.

#### Adjustments and Operation

With the pre-selector and at least one set of coils built, the constructor should go over his wiring carefully and check on opens and shorts in the few components. He should then work out some means of obtaining a proper B supply from his receiver.

The two tubes will draw from 15 to 20 milliamperes of B and .6 amperes of 6.3 volt "A" current, and if the receiver has insufficient reserve power to permit this additional drain on its transformer a separate supply may be necessary. Such a supply may be inexpensively built and will require simply a midget transformer, a miniature AC-DC choke and a power resistor which will (in series connection) drop rectified "B" output down to 250 or so volts, an 80 tube and socket, and a dual or 8-8 mf. electrolytic. Sometimes a receiver will supply the necessary "B" voltage but will not stand an additional .6 ampere of "A" current drain, and here we may simply get the high voltage from the receiver, relying on an auxiliary 6.3 volt filament transformer installed in the pre-selector cabinet to provide the 6K7 heater current.

B plus measurement at the R.F. tube plates should be approximately 250 volts, screen measurement 100 volts through 50,000 ohms dropping resistor, cathode voltage with the gain control wide open for full tube conductance—3 volts.

Now connect the antenna to one input post—shorting the other post to ground. (For doublet connection use both antenna posts and do not ground either one.) Then connect the output posts to the receiver input posts using as short as possible lengths of wire and running them through low-capacity shield tubing grounded at both pre-selector and receiver. Plug in the two coils, connect the power supply, open the ganged tuning condensers, set the manual trimmer for approximately middle capacity and the gain control for moderate amplification, and then adjust the trimmers within the coil forms for maximum noise level. Tune in various signals throughout the operating range, noting required readjustment for the manual trimmer, and change the connections on this trimmer from grid to plate circuits or vice versa if such seems necessary.

With a signal tuned in, advance the gain control for maximum level. The signal should come in strongly and sharply, with background noise falling off greatly.

Oscillation should definitely not be experienced with the gain control advanced. If it is present, then the capacity between plate coil and the grid cap and lead of the nearby 6K7 is too large and the feed-back too great. A shield partition should be placed between this coil and the tubes and, as effective shielding will entirely eliminate any feed-back and regeneration, some external means for coupling coil to grid circuit should be employed (such as an insulated wire, one end connected to the plate terminal at the coil socket, one end wrapped around but insulated from one grid lead) to secure a desirable maximum gain.

$$CS = \frac{C_1 \times C_2}{C_1 \text{ plus } C_2}$$

R.F. leads in particular—and use tie-points where necessary to keep small parts from moving about and making chassis or other contact when they shouldn't. Use physically small by-pass condensers and make every effort to bring all returns to one common ground point.

Coil sockets should be wired as the accompanying diagram indicates. Leads from the antenna input posts to the grid coil socket should be brought across the chassis depth through low-capacity shield-tubing and leads from the plate coil socket to the output posts should be short and direct.

If the cabinet and chassis which we have recommended are used there will be no space on the rear chassis wall for either a power-supply connection plug, or for an alternative four post A and B tie assembly. For that reason it is suggested that four leads (two for filament, one for ground, and one for B plus connection) be brought out the rear and through a low-capacity shield tubing (as shown) for soldering to a male plug. Such a plug should be connected in after the chassis has been installed in the cabinet, by the way, unless an opening is provided in the back of this cabinet large enough to permit the passing through of the plug.

#### Coils

Coil winding data is given in an accompanying diagram. Both grid and plate coils for a given band may be exactly alike in adjustment and number of primary and secondary turns, in which case they will be interchangeable. However, though the grid and plate windings in themselves must be alike to insure proper tracking and spotting, primary windings may have unlike characteristics if dissimilarity is found advisable because of antenna and output load matters.

The trimmers are installed in the coil forms, their two leads brought to separate prongs for parallel or series connection with the tuning condensers and as individual service suggests. If they are used in series, they will, of course, cut down the total tuning capacity appreciably and thus spread ordinarily narrow bands over a wider than normal amount of dial scale. The coils must be the more accurately wound to permit precise spotting and tracking, of course, and it will be imperative to bring the return lead for the variable condenser to one socket terminal for the series trimmer, to break the regular tuning condenser return to ground, and to connect the free trimmer socket terminal to chassis to complete the LC circuit.

The formula for capacities in series will be of value here in determining the maximum C and thus the minimum to maximum capacity variation.

## DATAPRINT SERVICE

New low price— Any 3 Prints.....\$1.00

### TESLA COIL DATA:

- Dataprint—drawings and data for building 36 inch spark Tesla.....50c
- Exciter—1 K.W. 20,000 Vt. Transf. ....50c
- 3" Spk. Tesla Coil. Works on Ford Coil.....50c
- 3" Spk. Oudin Coil. Works on 110 A.C. ....50c
- 20 "Tricks" with Teslas & Oudins.....50c
- 8" Spk. Tesla Coil.....50c
- Exciter—1/2 K.W. 15,000 V. Transf. ....50c
- Vibrator—1" Spk. Oudin, Vibrator Type How to Operate Oudins from V. T. Osc.....50c

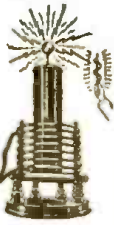

### S-W DIATHERMY (Artificial Fever)

Dataprint Constructional data for Small, Medium and Large size App.....50c

### RECORD PROGRAMS on Steel Wire!

Telephonograph Data, for Voice or Code.....50c



### Induction PIPE & ORE LOCATOR

Construction Data.....50c

### 20 ELECTRIC LODGE & PARTY TRICKS. Fun Galore!

"How to Do 'Em" Data 50c



### RADIO CONTROL for MODEL BOATS, etc.

Circuit data.....50c

### More DATAPRINTS You Need!

- 50c each Prepaid.....3 for \$1.00
- Water Turbines
- Water Wheels
- Motor Circuits (20)
- Telephone Hook-ups (20)
- 100 Mechanical Movements
- Polarized Relay, Ultra-sensitive
- Ring 4 bells on one circuit
- 20 Simple Bell Hook-ups
- Electric Chime Ringer fits any clock
- Welding Trf. 2 K.W. 110 V. Prim. 18 V. Sec.....50c
- "Rewinding" Small Motor
- Amateurs
- Induction Balance
- Telautograph
- Einthoven String Galvanometer
- Electric Furnace Draft
- Regulator
- Electric Pipe Thawer
- Simple Telephone
- Wheatstone Bridge
- Induction Coil—1 to 12 inch Spk. data.....50c

## The DATAPRINT Co.

Lock Box 322 RAMSEY, N. J.

On broadcast as well as shortwave frequencies, in any location, you can eliminate "man-made" static with

## NOISE-MASTER

ALL-WAVE ANTENNA

Send for complete literature.

CORNISH WIRE CO., 30 CHURCH STREET, NEW YORK CITY

Please mention SHORT WAVE & TELEVISION when writing advertisers



# JUST OUT!

## The New SPRAGUE CONDENSER Catalog



**FREE!**

The handiest, most helpful Condenser Catalog yet produced! Includes a complete listing of famous Sprague Condensers for every radio service and amateur need. Hundreds of exact duplicate replacements—new small size dry electrolytics—new Trimmers, Mica Condensers, Rectangular Transmitting Units, etc., etc. Don't miss it!

# SPRAGUE

The Standard of Condenser Quality

**SPRAGUE PRODUCTS CO.**  
North Adams, Mass.



**THE YEAR'S OUTSTANDING**

**SERVICE BOOK!**

Over 1,000 Pages

Over 1,000 Illustrations

## OFFICIAL RADIO SERVICE HANDBOOK

PUBLISHED only a few months ago, the OFFICIAL RADIO SERVICE HANDBOOK by Bernsley, is the most modern, up-to-the-minute volume on radio servicing. Contains over 1,000 PAGES filled with vitally important service data—over 1,000 ILLUSTRATIONS.

**OVER 250 PAGES OF OPERATING NOTES**  
The section on Operating Notes contains valuable information supplied from personal notes of hundreds of Service Men for over a thousand manufactured receivers.  
Other highlights of the OFFICIAL RADIO SERVICE HANDBOOK: **CIRCUIT THEORY AND ANALYSIS**—Circuit Fundamentals, Tuning Circuits and Aligning Data, Volume Control, Tone Control, A.V.C., Resonance Indicator Speakers, Flexams, Home equipment, Commercial Receivers; **SERVICING EQUIPMENT**—Fundamentals of Test Instruments, Commercial Equipment, Cathode-Ray Oscillograph, Building Test Instruments, Localizing Trouble, Short Cuts, Unusual Servicing Experience; **STANDARD AND SPECIALIZED RECEIVER AND INSTALLATION DATA**—All-Wave, Revolvers, Auto-Radios, Noise Interference; **MODERNIZATION AND CONVERSION DATA**—Receiver Conversion Work; **SOCIAL AND ECONOMIC PROBLEMS OF THE SERVICE MAN**—Improving Knowledge and Technique, Uplifting the Profession; **OPERATING NOTES FOR STANDARD RECEIVERS.**

Order your HANDBOOK today—use the coupon below  
**RADCRAFT PUBLICATIONS, Inc.** 99 Hudson St., New York, N. Y.

**RADCRAFT PUBLICATIONS, Inc.** SWT-937  
99 Hudson Street, New York, N. Y.  
Gentlemen: Enclosed please find my remittance of \$4.00 for which send me immediately, POSTPAID, one copy of the OFFICIAL RADIO SERVICE HANDBOOK by Bernsley—just published.  
 Please send HANDBOOK to me C. O. D.

Name .....

Address .....

City ..... State .....

Please send complete literature on HANDBOOK (Send remittance by check or money order. Register letter if you send cash or currency.)

- List of Parts and Materials**
- COIL DATA**  
L1—Antenna winding on grid form.  
L2—Grid winding.  
L3—Plate winding—similar to L2.  
L4—Output winding on plate form.  
(See text for data on above windings.)
- HAMMARLUND**  
C1 and C2—Type MC100-M variable condensers.  
C3 and C4—APC air trimmers, two for each set of coil forms, maximum capacity as required.  
C5—HF-15 midget variable.  
C—Optional—HF-15 midget variable.  
RFC—CH-X midget choke.  
2—FC couplings or two ICA 2101 couplings.
- AEROVOX**  
C6, C7, C8—Type 284 .05 mfd. tubular condensers.  
C9—Type 1467—.001 mfd.  
C10—Type 484—.1 mfd.  
R1—1 watt resistor—200 ohms.
- ELECTRAD**  
R2—Volume control type.  
R3—½ watt 50,000 ohms.  
P—6.3 volt dial and socket (socket to be soldered to panel).  
Male plug—Connector.
- OTHER ITEMS REQUIRED:**  
2—Round 8-pin steatite sockets.  
2—Round 6-pin steatite sockets, with adapter plates.  
1—Three-post antenna assembly (Two posts insulated).  
1—Two-post output assembly (Both posts insulated).  
2—Nameplate knobs.  
1—Nameplate dial.  
1—Cabinet and chassis, to layout specifications.
- RAYTHEON**  
2—6K7 tubes, with isolantular insulation between shells and grid-cap terminals.  
50 feet—No. 20 hook-up wire.  
2 feet—Low-capacity shield tubing.  
2 Stand-off insulators—1 ¼" between mounting hole centers.  
1—dial, airplane type.

## New S-W Apparatus for HAMS

(Continued from page 242)

### The New 866 Jr.

(Half-Wave Mercury Vapor Rectifier)

● The 866 Jrs. fill a real need for intermediate power requirements. They are intended to be used as rectifiers in power supplies of from 600 to 1000 volts D.C. where the receiving type full-wave rectifiers will not stand up and where the power capabilities of the Heavy Duty 866's are not necessary. The smaller size of the 866 Jrs. is another feature that will prove to be of great advantage in the layout of compact power supplies.

The 866 Jr. uses the multi-strand filament. The multi-strand filament construction used in these rectifiers has twice the emitting surface of the nickel-alloy ribbon-type filaments used in ordinary 866's. The longer life secured with heavy duty 866's has proven that the use of the multi-strand filament results in better rectifiers.

**GENERAL CHARACTERISTICS**

Fil. Volts	2.5 V
Fil. Current	2.5 A
Max. RMS A.C. Volts	1250
Max. D.C. Current per pair (Choke input)	250 M.A.

**PHYSICAL CHARACTERISTICS**

Max. Length, Inches	5 ½
Max. Diameter, Inches	2 ¼

UX Ceramic Base  
Connect plate terminal to usual position standard on all UX buses.

### The Editors Want

articles describing in detail television receivers on which short-wave experimenters may pick up the television images being broadcast by the RCA Station, in New York City, on about 5 meters, and also those being broadcast in Los Angeles and Philadelphia. All articles accepted and published will be paid for at regular space rates. Send outline of article and what diagrams available to: The Editor, Short Wave and Television, 99 Hudson St., New York, N. Y.

# GET YOUR COPY TODAY!

## Chock-Full of Helpful Information



**FREE!**

LEARN the truth about so-called "bargain" condensers—get the facts about power factor, leakage, etc. This new 1937 Catalog also includes the famous Sprague Tel-U-How Condenser Guide: complete data on Radio Interference Elimination, duplicate replacements, etc., etc. Get your copy today!

# CONDENSERS

USE SPRAGUES and Note the Difference

**SPRAGUE PRODUCTS CO.**  
North Adams, Mass.

## TR-6A6 TRANSMITTER—RECEIVER

### FOR 5-METER BAND DUPLEX OPERATION

A complete 5-Meter Station, including a Receiver and Transmitter for DUPLEX break-in operation. Both units housed in a sturdy black crystalline cabinet, with separate tuning dials and speaker.

AMATEUR PRICE \$39.75 NET LESS TUBES  
Also A Crystal Controlled Model

## Write for new 1937 catalog CAMERADIO

963 LIBERTY AVE. PITTSBURGH, PA. ● 30 TWELFTH ST. WHEELING, W.VA.  
Established 1919

## STOPPANI COMPASS

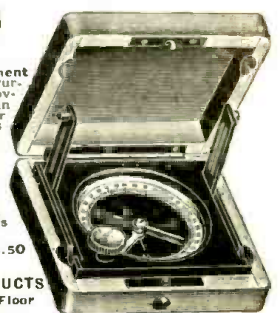

A Precision Instrument made in Belgium. Purchased by the U. S. Government at more than \$30.00 each. Ideal for Radio Experimenters Laboratory, also may be used as a Galvanometer for detecting electric currents in radio circuits. Ruby jeweled, solid bronze, 4 inches square, fitted in a hardwood case. Also used by hunters and surveyors.  
Our price prepaid \$4.50 each

**GOLDSHIELD PRODUCTS**  
99 Hudson St., 11th Floor  
New York City

## BLILEY CRYSTALS

20-40-80-160 Meter Bands  
\$3.95 up.  
Bliley Electric Co., Erie, Pa.

Please mention SHORT WAVE & TELEVISION when writing advertisers



ON TELEVISION AND SHORT WAVES . . .

TWO GREAT BOOKS

Hundreds of readers of SHORT WAVE AND TELEVISION with long term subscriptions complained to us because we offered the two books, ABC OF TELEVISION and SHORT WAVE GUIDE, only with subscriptions. THEY WERE NEVER SOLD.

In view of the importance of these books to short wave and television fans we have decided to make them available to our readers, at the nominal cost of fifty cents each, only for a very short time. YOU NOW HAVE THE OPPORTUNITY TO BUY THESE BOOKS . . . WE SUGGEST YOU ACT PROMPTLY BECAUSE WE CANNOT GUARANTEE THE OFFER TO BE REPEATED NEXT MONTH. Use the coupon below to order.

ABC OF TELEVISION

This book contains only the latest material available on Television. It is written by a well-known radio authority.

PARTIAL CONTENTS OF ABC OF TELEVISION
The simplest television receiver; how the eye sees—Theory of scanning; the Nipkow disc



and its relation to television; the photo-electric cell; neon lamps; brief description of several modern mechanical systems—Need for a large number of picture elements; need for broad channel width in transmission of high-fidelity television signals—The use of the cathode-ray tube in television receivers; necessary associated equipment used in cathode-ray systems—How a television station looks and operates—The Iconoscope as used for television transmission in the RCA system—The Farnsworth system of television transmission—The future of television.

64 PAGES—100 ILLUSTRATIONS. STIFF, FLEXIBLE COVERS, 5 1/2 x 8 1/4 INCHES

50c Postpaid

SHORT WAVE GUIDE

It is an excellent book—recommended by short-wave enthusiasts everywhere.

PARTIAL CONTENTS OF SHORT WAVE GUIDE

SHORT-WAVE QUESTIONS AND ANSWERS—SHORT-WAVE KINKS, thus treated—HOW TO BUILD SIMPLE SHORT-WAVE RECEIVERS—WHICH IS THE BEST TYPE OF AERIAL TO USE?—A SIMPLE "HAM" TRANSMITTER—All the details, including list of parts, wiring diagrams and constructional details in building a simple "ham" transmitter will be found in this book—PRACTICAL HINTS ON SHORT-WAVE TUNING

64 PAGES—100 ILLUSTRATIONS. STIFF, FLEXIBLE COVERS, 5 1/2 x 8 1/4 INCHES. 50c Postpaid

ADD THESE BOOKS TO YOUR TECHNICAL LIBRARY!

Here are two fine books which the Editors of SHORT WAVE AND TELEVISION have written for you. Each volume brings you new, as well as important developments in each field. Read these books not just once, but over and over again . . . you'll find them a big help.

SHORT WAVE & TELEVISION
99-5 Hudson Street, New York, N. Y.

EVERY RADIO FAN WANTS TO READ THEM!!

MAIL COUPON TODAY!

SHORT WAVE & TELEVISION
99-5 HUDSON STREET, NEW YORK, N. Y.

Gentlemen: Enclosed you will find my remittance of \$..... for which please mail to me POSTPAID, the book or books indicated below:

- ABC OF TELEVISION @ 50c
SHORT WAVE GUIDE @ 50c

Name .....

Address .....

CITY ....., State ....., Send remittance in form of check, money order or unused U. S. Postage Stamps. (Foreign: International Postal Money Order.) Register letter if you send cash.

G.E. PHONOGRAPH MOTOR

VARIABLE speed induction type self-starting, 110 volt, 25 to 60 cycle. AC with speed control. Plug and cord. Speed ranges from 5 to 200 RPM. Shipping Weight—12 lbs. Shipped express collect.



Only \$4.95

WESTINGHOUSE UNIVERSAL MOTOR

SPECIFICATIONS: 1/30 HP, operates on either AC or DC. 110 volts. 5000 RPM. Rheostat can be used to vary speed. Height 3 3/4", Length 3 3/4", Width 1 3/4", Shaft 3/8" one inch long.

MOTOR only \$2.95

MOTOR with Arbor and 3/4" Chuck \$3.95

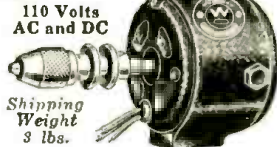

Add 25c for special packing and mailing anywhere in U.S.A.

WELLWORTH TRADING CO.
560 W. Washington Blvd., Dept. SWT-937, Chicago, Ill.

RADIOS..SAVE UP TO 50%

Deal direct...factory prices! Many models to select from: AC-DC, All-Wave, Farm sets that operate like city radios! Your name and address on postcard brings you NEW Bargain Catalog in color FREE. Get details of 30-DAY TRIAL Plan and agent-user proposition! GOLDENTONE RADIO CO. Dept. CS, DEARBORN, MICHIGAN

SET BUILDERS, SERVICEMEN, RADIO EXPERIMENTERS
DON'T BUY RADIO PARTS UNTIL YOU HAVE SENT FOR OUR SUMMER BULLETIN.
UNITED RADIO CO., Dept. S-9, Newark, N. J.

A Simple, Rotary 5-Meter Beam Antenna

(Continued from page 228)

away. While our own beam was actually in the air for nearly a month before we had an opportunity to use it, we had plenty of time to observe the manner in which it would withstand the wind and two weeks ago, we had one of the most severe wind storms that Long Island has seen in several years. No difficulty was experienced.

The Brach type FP-999-W broadcast antenna poles are provided with a mounting bracket which is bent to an angle of forty-five degrees. We bent this bracket to an angle of ninety degrees and it formed an ideal support for the antenna itself.

It happens that our crystal has been cut to oscillate on a frequency of 7,245 kilocycles and by suitable doubling, as explained in our article last month, we came to an ultimate frequency in the final stage of 57,960 kilocycles. Extending the telescopic fishpoles to their limit produces rods which are 96 1/2" long and that is just about correct for the frequency on which we are transmitting. Such poles can be used satisfactorily from the middle to the high frequency end of the five meter band but they are not satisfactory for frequencies below 58 megacycles.

The crossarm that we use is made of a piece of well seasoned pine two inches square and one-hundred and five inches long. Two radiators are mounted on the upper side of this cross-member and two are mounted on the lower side. A piece of heavy, insulated wire is provided with this type of fishpole and by joining these lead wires from the two upper radiators at the center and following the same procedure with the two lower radiators we have an "H" beam which might very well be fed by a low impedance transmission line.

In our case, however, we preferred to use an open line for a part of the run to the shack and a junction to the open line is made, without introducing any serious difficulties by insulating the ends of the low

impedance twisted pair up and down the last foot or so of the open line until the best point is found, in the usual way. A satisfactory point for starting to locate the optimum junction between the open line and the low impedance twisted pair is to make the open line any number of half wavelengths long.

A Simple Spaced Pair

A few years ago we designed a special type of transposition block, for use in connection with the making of noise-reducing antenna. These blocks provide one of the simplest methods of making an open transmission line because they keep the wires separated the correct distance, they can be inserted in the line without any tie-wires and any time that it is found desirable to insert additional spreaders these transposition blocks can be used very satisfactorily. When a transmission line of this type is made it should be borne in mind that the wires are NOT transposed. The wire we used is approximately the equivalent of No. 14 solid and, as it becomes automatically spaced with the use of these transposition blocks, we provide ourselves with a line having an impedance of approximately 450 ohms. The losses in a line of this kind are negligible, even at five meters. This is not true of any twisted pair nor is it true of any type of coaxial conductor. So, wherever an open spaced pair can be used, particularly on the ultra hi-frequencies, it should be used and the use of nothing but the best twisted pair should be used in conjunction with it.

Making the Beam Rotate

The simplest method for mounting the 2 x 2 inch cross-member on the top of our 3 x 3 mast would be to drill a reasonably small hole through the 2 x 2 and run a fairly long lag screw into the top of the mast, placing a metal washer between the head of the lag screw and the top of the cross member and another one between the bottom of the cross-member and the top of the mast. Such an arrangement is all right for a temporary affair but it is certainly not workmanlike and we believe that the arrangement that we have used will be welcomed by those amateurs who contemplate making their rotary beams more substantial. The arrangement that we have used is a very simple but very effective one.

We secured a copper contact, of the type which is used on large elevator controls from the Chas. E. Chapin Company\* which happens to have its headquarters in our own building in New York City. The contact that we use is known as No. 109 and it has an outside diameter of 2 1/4". The base is 3/8" thick, the pin is 2 7/8" long and the diameter of the pin is 1/2". We drilled three holes through the base and then counter-sunk the holes so that the contact itself could be fastened to the top of the mast with three wood screws. Insulating bushings for these copper contacts are stock items and they are made of molded bakelite. They have a bottom surface which is equivalent to the surface of the base of the copper contact. We drilled a hole through the cross-member and sunk the bakelite bushing into the hole and that gave us a very satisfactory bearing and prevented any side swaying of the cross-member. Plenty of vaseline was applied to the upper surface of the copper contact and the lower surface of the bakelite bushing. The complete antenna can be rotated so easily that it turns as though it was mounted on ball-bearings.

The manner in which the rotation is effected may be seen from the accompanying sketch.

In designing the ultra high frequency antenna it should be borne in mind that we are very likely to run into a situation where more than ordinarily good insulation will be required. This is especially so if the ultra hi-frequency transmitter is being operated on reasonably high power, as is the case in connection with our own transmitter. It will be seen from one of the sketches that National Steatite stand-off insulators have been attached to the center of the cross-member so as to provide suitable insulation at the central portion of the matching section of the antenna itself.

\*Address furnished upon request.

Please mention SHORT WAVE & TELEVISION when writing advertisers



# Piping R.F. With Concentric Lines

(Continued from page 230)

the transmitter have encouraged this practice generally. These advantages include among others greater freedom from spurious coupling effects in the transmitter which are produced by the strong electric fields immediately beneath the antenna structure, and a greater degree of flexibility in the overall design. Under these conditions, however, the radio frequency connection to an antenna required is generally of sufficient electrical length to warrant careful consideration of its electrical properties from the standpoint of transmission line theory if an efficient, trouble-free connection is to be provided.

Within the past few years the concentric type of transmission line has been gaining in favor over the open-wire type. In addition to providing far more constant electrical characteristics, this type of line offers many other attractive advantages. Concentric transmission lines may be buried in the ground since all of the radio energy is totally enclosed by the outer conductor. Thus the hazard of unsightly exposed wires carrying high voltages is eliminated and the possibility of spurious couplings between the antenna and line are prevented. Furthermore, the concentric line will not be a source of harmonic radiation and is not affected by weather conditions.

The outward appearance of these lines is simply that of a metal tube or pipe. A cross sectional view, however, reveals an inner coaxial conductor which for the sake of economy is frequently made hollow. This inner conductor is generally supported by toroidal shaped, ceramic insulators spaced so that by far the greater part of the medium between the inner and outer conductors is air or gas. Calculations and experimental verifications have shown that a most desirable ratio of diameters\* of these conductors exists and that this ratio is ordinarily between 2.7 and 3.6 to 1. While the ratio is not very critical, there is considerable justification for employing lines having a ratio of diameters within this range. The ratio 2.7 to 1 represents the optimum ratio from the standpoint of corona formation and voltage flashover, while the 3.6 to 1 ratio corresponds to the minimum radio frequency loss conditions, both for a given size outer conductor. Also, these ratios present no particular mechanical problems.

Typical concentric radio frequency transmission lines cut away to show the insulators and inner conductors are shown in one of the photos. These lines are manufactured in sizes ranging from a fraction of an inch to several inches in diameter. The fourth line from the right is used to transmit radio frequency powers up to 15 kilowatts and the second line from the right will handle up to 100 kilowatts.

In contrast to the complex nature of the electro-magnetic field about open-wire transmission lines, concentric lines present well defined field patterns. The diagram depicts such a pattern. The electromagnetic field, as in any conductor of electric currents, radiates outward from the conductor in a series of concentric rings; whereas the electrostatic field extends radially outward from the inner conductor cutting the magnetic field at right angles similar to the spokes of a wheel. The fields, as may be seen from the diagram, are entirely confined to the medium between the internal surface of the outer conductor and the external surface of the inner conductor. It is for this reason that no radiation takes place from the line, permitting it to be buried in the ground if desired.

The flow of electric current becomes more confined to the surface of the con-

ductors as the frequency is increased, thereby increasing the current density for a given current and in turn increasing the conductor losses. At broadcasting frequencies, the current may be considered as confined to very thin conducting surfaces. It is interesting to note in this connection that at ultra high frequencies a tarnished wire exhibits a measurably higher resistance than a polished one. Neglecting dielectric losses, which can be made small in well constructed concentric transmission lines, the losses are proportional to the square root of the frequency.

The conductor losses are also inversely proportional to the diameters (with fixed diameter ratio) and proportional to the square root of the resistivity of the conductors. At broadcasting frequencies, the losses in copper transmission lines with air or gas dielectric are for most practical purposes negligible and, in general, less than the losses in the associated circuits.

One of the most fundamental parameters of a transmission line is its characteristic impedance. This is a function of its several distributed electrical constants but may be easily computed, however, from its physical dimensions. It is desirable, for several reasons, to terminate a transmission line in a pure resistance load equivalent in value to the characteristic impedance. By so doing, standing waves are avoided which if present may cause corona discharges or flashover within the line at nodal points. Also, the input impedance is then equal to the load impedance irrespective of the length of the transmission line, so that the transmitter output circuit can be designed to work into a predetermined transmission line impedance.

The design of lines suitable for transmitting a specified amount of radio frequency power safely must also involve a consideration of the voltages which are to be imposed on the line. This voltage in the case of a line terminated in its characteristic impedance ( $Z_0$ ) remains constant throughout its length and is simply:

$$E = \sqrt{P Z_0}$$

where P is the radio frequency power at the carrier in watts.

E is the radio frequency r.m.s. voltage at the carrier.

This must be multiplied by 1.414 to obtain the radio frequency peak voltage at the carrier and again by 2 to obtain the radio frequency peak voltage at 100% modulation.

In a concentric transmission line the maximum voltage gradient occurs at the surface of the inner conductor. A smooth line free from insulators and perfectly concentric flashes over at radio frequencies when this gradient exceeds about 20 kv/cm. The presence of insulators, slight irregularities in the surface of the conductors, etc., often produces this gradient at localized points on the inner conductor long before the same gradient on a smooth part of the surface is reached; consequently the breakdown voltage is not readily calculated from standard formulas with any great degree of accuracy.

Theoretically for two lines of similar construction but of different cross-sectional dimensions, the ratio of their breakdown voltages is proportional to the ratio of their characteristic impedances times the ratio of their inner conductor diameters. However, experiments have shown that due to the large number of other variable factors involved, it is advisable to measure the actual breakdown voltage in each case to obtain definite information.

A notable example of the use of concentric transmission lines is at the new 50 kilowatt station WOR in Carteret, N. J., in connection with a three-element, directive antenna system designed by Bell



'HF' MICRO CONDENSER

## .. For Better Radio

For better radio, use the new 'HF' micro condensers with their many advanced features guaranteeing highest efficiency in tuning or trimming critical high frequency circuits. Cadmium plated soldered brass plates and Isolantite insulation insure rigidity, stability and lowest losses. Noiseless operation. Single and dual types—10 sizes—15 to 140 mmf.

Write Dept. SWT-9 for 'HF' Bulletin

HAMMARLUND MFG. CO., INC.  
424-438 West 33rd St., N. Y. City

- Please send me 'HF' bulletin.
- Please send me "37" catalog.

Name .....

Address .....

City ..... State .....SWT-9



HAMMARLUND

## PAR-METAL RACKS—PANELS—CABINETS

—a size and style  
for every requirement



PAR-METAL offers you a uniform line of standardized metal products that enables you to quickly build up a job that is professional both in construction and appearance.

THE RACKS, cabinets, panels, etc., are the result of many years experience in making similar equipment for the sound industry. All of these products have been designed and made by a modern plant that has fabricated about everything from a small shield can to the metal work on a broadcast station.

All of the parts are available in various standard sizes—a complete line that will meet almost every requirement.

WRITE FOR COPY OF OUR CATALOG NUMBER 37

PAR-METAL PRODUCTS CORPN.  
35-27 41st ST., LONG ISLAND CITY, N. Y.

## BRUNO Velotron

SPECIAL  
PURPOSE  
MICROPHONE

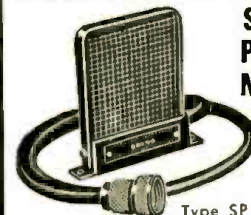

Extremely compact, this low cost microphone is the ideal job for amateur and experimenter use. Available at all progressive distributors.

Write for FREE Type SP data. Only \$19.50 list.

BRUNO LABORATORIES, INC.  
30 West 15th Street, New York

\* The ratio of inner diameter of the outer conductor to the outer diameter of the inner conductor.

Please mention SHORT WAVE & TELEVISION when writing advertisers



# AMERICA'S MOST POPULAR RADIO BOOKS

We herewith present a selected collection of recent important radio books. We have selected these volumes because they represent the foremost radio books of their kind in print today. We publish no catalog. Order direct from this page. Prompt shipments will be made to you. Remit by money order or certified check. Register all letters containing cash.

<b>SHORT WAVES.</b> 384 pages, 258 illus.	<b>\$ .69</b>
<b>PRACTICAL TELEVISION.</b> 223 pages, 127 illus.	<b>\$3.69</b>
<b>ELEMENTS OF RADIO COMMUNICATION</b> 286 pages	<b>\$2.98</b>
<b>RADIO PHYSICS COURSE.</b> 992 pages, 510 illus.	<b>\$4.00</b>
<b>THE RADIO AMATEUR'S HANDBOOK,</b> 448 pages	<b>\$1.97</b>
<b>RADIO THEORY AND OPERATING.</b> 1,000 pages; over 800 illus.	<b>\$4.38</b>
<b>MODERN RADIO ESSENTIALS.</b> over 200 pages, and over 100 illus.	<b>\$1.95</b>
<b>FOUNDATIONS OF RADIO.</b> 248 pages, 145 illus.	<b>\$2.47</b>
<b>PHOTOCELLS AND THEIR APPLICATION.</b> 332 pages, 180 illus.	<b>\$2.88</b>
<b>ELECTRONICS,</b> 134 pages, 45 illus.	<b>\$1.95</b>
<b>SHORT WAVE RADIO HANDBOOK.</b> 128 pages, 150 illus.	<b>\$1.00</b>
<b>PRINCIPLES OF RADIO.</b> 478 pages, 306 illus.	<b>\$3.46</b>
<b>EXPERIMENTAL RADIO.</b> 256 pages, 168 illus. Prepaid.	<b>\$2.69</b>
<b>MODERN RADIO SERVICING</b> 1300 pages, over 700 illus.	<b>\$4.00</b>
<b>DRAKE'S CYCLOPEDIA OF RADIO AND ELECTRONICS,</b> 1050 pages, 1178 illus.	<b>\$4.88</b>

<b>FUNDAMENTALS OF RADIO</b> 426 pages, illustrated. Prepaid.	<b>\$3.46</b>
<b>ELECTRICITY AT HIGH PRESSURES AND FREQUENCIES.</b> 248 pages, 141 illus. Prepaid.	<b>\$1.89</b>
<b>RADIO CONSTRUCTION AND REPAIRING,</b> 444 pages, illustrated	<b>\$2.50</b>
<b>THEORY OF VACUUM TUBE CIRCUITS,</b> 226 pages, 226 illus.	<b>\$3.00</b>
<b>PRINCIPLES OF RADIO COMMUNICATION,</b> 988 pages, profusely illus.	<b>\$7.35</b>
<b>RADIO ENGINEERING.</b> 688 pages, 418 illus.	<b>\$5.00</b>
<b>EXPERIMENTAL RADIO ENGINEERING.</b> 346 pages, 230 illus.	<b>\$3.46</b>
<b>RADIO OPERATING QUESTIONS AND ANSWERS.</b> 422 pages, 106 illus.	<b>\$2.50</b>
<b>OFFICIAL RADIO SERVICE HANDBOOK,</b> over 1,000 pages, over 1,000 illus. Prepaid.	<b>\$3.92</b>
<b>OFFICIAL SHORT-WAVE RADIO MANUAL,</b> 240 pages, many illustrations. Vol. 1 (1934) Prepaid.	<b>\$2.00</b>
<b>Vol. 2 (1935) Prepaid.</b>	<b>\$2.50</b>
<b>OFFICIAL RADIO SERVICE MANUAL, Volume 4,</b> 2,000 illus., over 400 pages. Prepaid.	<b>\$3.43</b>
<b>OFFICIAL RADIO SERVICE MANUAL, Volume 5,</b> over 3,000 illus., over 1,000 pages. Prepaid.	<b>\$6.86</b>
<b>OFFICIAL RADIO SERVICE MANUAL, Volume 6,</b> over 1,200 pages, over 2,500 illus. Prepaid.	<b>\$6.86</b>

## 15 HANDY—POCKET-SIZE RADIO BOOKS

Here are 15 up-to-date books on radio and air conditioning. Modern in every sense. ALL BOOKS UNIFORM—They contain 64 pages; 50 to 124 illustrations. All books written by well-known authors. Order by Number.

2. MODERN VACUUM TUBES
3. THE SUPERHETERODYNE BOOK
5. HOW TO BECOME A SERVICE MAN
6. BRINGING ELECTRIC SETS UP TO DATE
8. RADIO QUESTIONS AND ANSWERS
9. AUTOMOBILE RADIO AND SERVICING
10. HOME RECORDING AND ALL ABOUT IT
12. PUBLIC ADDRESS INSTALLATION AND SERVICE
13. ABC OF AIR CONDITIONING
14. POCKET RADIO GUIDE
15. ABC OF REFRIGERATION
16. PRACTICAL RADIO CIRCUITS
17. SERVICING WITH SET ANALYZERS
18. POINT-TO-POINT RESISTANCE ANALYSIS
19. PRACTICAL RADIO KINKS AND SHORT CUTS

PRICE PREPAID EACH BOOK **49c**

### HOW TO ORDER

No. C. O. D. orders. Our prices are net, as shown. Some of the books sent prepaid (in U. S. only). Those that are not thus listed are shipped collect if sufficient postage is not sent. Add 7% of Price for postage.

of a given length, it is necessary to consider the impedance of the load at the harmonic frequency. The most desirable load impedance at the harmonic frequency will depend entirely upon the particular length of transmission line which is used. Thus, for example, a line which is approximately a quarter wavelength long at the harmonic frequency should be terminated in a low harmonic impedance in order to produce a desirable high impedance at the sending end.

On the other hand, a line which is approximately a half wavelength long should be terminated in a relatively high harmonic impedance. Under favorable conditions, harmonics delivered to the antenna may be suppressed 50 db or more by the application of such a shunt. The new 50 kilowatt station WJR at Detroit makes use of a quarter wavelength concentric transmission line harmonic shunt to suppress the second harmonic radiation which, in this case, is the exact operating frequency of another Detroit station.

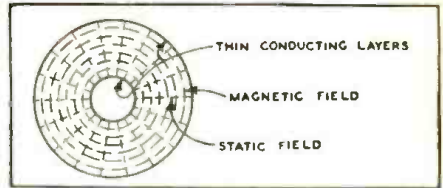

Static and Magnetic Fields

With the advent of tall radiating structures, the problem of suitable tower lighting circuits has become of some importance. In many cases large electric signs displaying the station's call letters, etc., have imposed unusually heavy requirements upon these circuits, which must be designed to prevent the flow of radio frequency energy from the antenna structure to ground and at the same time allow the free passage of low frequency power to the lights.

At station WWJ in Detroit a quarter-wave concentric transmission line serves in the above capacity. The inner conductor of the line is the conduit which carries the lighting wires from the source to the lights. The outer conductor extends from the antenna base back towards the transmitter for a quarter wavelength and is then short-circuited to the inner conductor. This quarter wavelength section of concentric line, as well as the remaining length of conduit, is buried except for a short vertical section at the antenna where the connections emerge from the ground. Large amounts of low frequency power can in this way be economically and efficiently fed to the lights. In addition, this tower lighting connection serves to suppress even order harmonic radiations and provides a static drain for the antenna.—Courtesy of "Pick Ups"—Western Electric Co.

## RADIO PUBLICATIONS, 97 HUDSON ST., NEW YORK, N. Y.

### More and More Radio Men Are Reading RADIO-CRAFT!

RADIO-CRAFT is devoted to all phases of radio, to servicing, and to the advanced set builder. Brings you shortcuts that show you the way out of difficult problems. Latest Radio Equipment is illustrated and described. Then there's the International Radio Review, Service Data Sheets, New Tubes, Radio Month in Review, Set Construction, Television, operating Notes, and other interesting departments. Edited by Hugo Gernsback. Over 175 Illustrations in each issue.

**8 Months \$1**  
for

**RADIO-CRAFT, 99 C Hudson Street, New York, N. Y.**

# MILADY

The Woman Magazine Sensation

MILADY combined with WOMAN'S DIGEST is the magazine of, by and about women—it brings you inside facts on many popular subjects. There's tips on fashions, beauty secrets, child problems, religion and the home. Monthly each brings you three or four short stories and best reviews from the world of Drama. MILADY has a beautiful three-color cover and contains many full-page illustrations. For your number, your single copy or a year's subscription, on all send no stamps at all. A copy or Send \$1.00 to publishers for the next five monthly issues. MILADY, 99-SW Hudson St., New York, N. Y.

ohm. This property makes the quarter-wave line valuable as a shunt for suppression of the even harmonic frequencies flowing in the main transmission line connecting the transmitter to the antenna. A similar shunt for the third harmonic and its multiplier is obtained in a line which is short-circuited at a distance equal to one-sixth of the operating wavelength.

The one-sixth wave line exhibits a positive input reactance at the operating frequency. While this property makes it impossible to bridge it across the main line as in the case of the quarter-wave line without proper coupling means, the positive reactance can be anti-resonated with a line, in parallel at the coupling point, which is equal to one-twelfth of the operating wavelength and open-circuited at the far end. The latter line will offer further attenuation to the odd harmonics.

The attenuation offered to the harmonics by these shunts depends upon the ratio of the harmonic impedance of the main line to that of the shunt, since the output of the transmitter may be considered as a source of constant harmonic current. Expressed in decibels, this attenuation is:

$$db = 20 \log_{10} \frac{Z_1}{Z_n}$$

where  $Z_1$  is the harmonic impedance of main line.

$Z_n$  is the harmonic impedance of shunt line.

When the shunt is connected across the sending end of the main transmission line

Telephone Laboratories. In this installation a 2½" O.D. copper line is employed. The line is filled with nitrogen gas under pressure which serves to exclude the possible entrance of moisture and to provide an additional factor of safety by more than doubling the normal breakdown voltage. Two of the photos show close-up views of details of this line. Gas valves and connections are partially visible in one of the photos.

Concentric lines have been found to exhibit certain electrical properties which render them useful in performing special duties as circuit elements. Sections of line which are either short-circuited or open-circuited at the far end are equivalent at the near end to substantially pure inductances and capacitances varying cyclically between zero and infinity as the length of the section is varied.

In the significant case of a quarter-wave line which is short-circuited at the far end, the input impedance approaches infinity at the operating frequency, while at even harmonics of this frequency the input impedance is but a fraction of an

## 1938 Super Sky rider

(Continued from page 232)

tubes—4 metal, 7 glass, and they function as follows: 6K7 R.F., 6L7 first detector, 6J5G oscillator, 6K7's in the two I.F. stages, 6R7G second detector, AVC and first audio, 2V6G beam tube power-amplifiers, 6J7G signal indicator amplifier and a 6Z3 full-wave rectifier. The band-spread dial and the signal meter dial are illuminated; air trimmers are used. The undistorted power output is 13 watts with a maximum of 18 watts. The set measures 11" deep, by 9¼" high, by 21" long. The various controls on the panel are: tone control, AVC, "on-and-off" switch, BFO injector, "send-receive" switch, A.F. gain, Band-Switch, R.F. Gain, Selectivity (broad and sharp), Pitch Control for heat oscillator, and crystal (in-and-out) and phasing control.

This article has been prepared from data supplied by courtesy of The Hallcrafters, Inc.

Please mention SHORT WAVE & TELEVISION when writing advertisers



## High Efficiency Doubling

(Continued from page 231)

generation of new frequencies which are multiples of the exciting frequency. But with all of this an efficiency of 30% can be considered good, with considerable less efficiency on the ultra-high frequencies. And we haven't mentioned the "trickiness" usually associated with such doublers.

### Push-Push Doubling—Its Features

But in *push-push* doubling the picture is entirely reversed because in reality the tube or tubes are acting as a straight amplifier with its attendant high efficiency. Figure 1 shows the fundamental circuit. Here we see that the grids are connected in push-pull and the plates in parallel. This circuit doubles the frequency, *not because of distortion*, but because each RF impulse applied to the grid circuit results in two impulses in the plate circuit. Thus there are twice as many impulses in the plate circuit as there are in the grid circuit, or in other words, the frequency of the plate tank is twice that of the grid tank. The ultimate result is that the output is all second-harmonic output and efficiencies of 60 to 70% are the rule and not the exception. This means, "believe it or not," that in the push-push doubler stage the output on the second harmonic will be greater than the output of a single tube used in the same stage as a straight amplifier. And this is a very welcome condition as every amateur will readily testify.

The single tuning condenser in the grid circuit and the by-pass condenser from the center of the coil to ground, allows half of the grid coil to act as an *untuned* grid coil of a TNT oscillator with consequent spurious oscillations. *Fig. 3 will cure all this and has never failed to work.* Here the split-tuning condenser across the grid coil, with the rotors connected to the center of the filament circuit and grounded, delivers an equal amount of RF to each grid and provides a capacitance reactance to the second harmonic, which in turn prevents spurious oscillations in the doubler circuit.

Figure 4 illustrates how the push-push doubler can be converted to a *push-pull* amplifier with a minimum amount of trouble. This circuit is first set up as a push-pull amplifier and the stage neutralized in the usual manner. Then to use as a push-push doubler, no changes are necessary—other than to use a plate coil of *twice the frequency* and connect the plates in parallel. This can be effected by a switch as shown.

### An Interesting Circuit Using a "Dead" Tube

Figure 5 is very interesting, especially when applied to neutralization. To use as a *push-push* doubler, the circuit is exactly the same as Fig. 3. But to use this circuit as a straight amplifier a plate tank of the same frequency as the grid tank is used and one side of one filament is opened. This "dead" tube, due to its internal capacities, effectively and completely neutralizes the other tube. For the amateur who has one good tube and another burned-out tube of the same kind, this is a Godsend as he can change frequencies at will and forget about neutralization. No difficulties with this circuit should be encountered but if the stage is not completely neutralized reverse the filament leads to the dead tube and this will usually effect a cure.

In the foregoing we have spoken solely of doubler "stages," but there is no reason why the same can not be said for using this circuit as a final amplifier. In fact I personally prefer this circuit as a *final*, due to its *efficiency and simplicity*.

Fig. 4 illustrates how to get about the same output on two consecutive bands with the changing of only one coil and the throwing of a switch. For the amateur who has a number of crystals and likes to work in different parts of the bands,

or for the phone amateur, where complete neutralization is a necessity and sometimes a problem, the circuit of Fig. 5 is ideal.

As to the proper tubes to use—any of the ordinary tubes used as class C amplifiers will work OK. The common 45's, 10's, and 211's are fine, down to and including 20 meters. The same can be said for 46's with their grids *tied together*. On the higher frequencies, 10 meters and up, 42's, 53's, 50T's work better than the higher C tubes. Some of the newer tubes with their very low inter-electrode capacities should make ideal *push-push doublers* at all frequencies. Remember that the output capacity of the tubes are in parallel and consequently some experimenting may be necessary to get a low C plate tank. In order to get the highest efficiency both grid and plates should be as low C or high inductance as possible, and the grid circuit should be kept symmetrical.

The 53, 6A6, RK34 are known as *twin triodes* and therefore make ideal low-power *push-push* doublers. See Figure 6. A 53 with 350 volts on the plates will put out 10 watts of RF down to and including 10 meters. They will work on 5 meters but at a somewhat lower efficiency. More output can be secured by raising the plate voltage and then it would be advisable to insert a 400 ohm, 10 watt resistor in series with the cathode to provide some automatic bias.

Figure 7 shows a novel development of the circuit as applied to a twin triode and shown in the new transmitter kit of the Phelps-Dodge Corp. Here a .01 mf. mica condenser and a switch are connected across the plates. With the switch closed the circuit acts as a normal push-push doubler. With the switch open the DC is cut off from one plate, yet leaves the circuit capacities practically unchanged. Thus the "dead" section neutralizes the other section and the circuit acts as a *straight amplifier*.

The problem of doubling from 10 meters to 5 meters is probably the toughest one of all. Yet Fig. 8 shows how it can be done and is the only one I have seen where any appreciable power gain was realized. The tubes used are 42's or 2A5's. While the screen voltage can be obtained from a dropping resistor, it is advisable to use a tapped bleeder arrangement as shown. With too *high* voltage the screens run hot, and with too low voltage the output drops off so the variable screen voltage arrangement is preferable. With 400 volts on the plates 10 to 15 watts of RF on 5 meters can be obtained without any difficulty.

A high-output *crystal oscillator* with low crystal current is something we usually strive for. Figure 9 illustrates such an oscillator with equal output on two consecutive bands. The circuit shows type 59 tubes used with their screens and suppressors tied together, although 802's or RK25's would give more than twice the output of 59's. Two coils are used—one tuning to the crystal frequency and another tuning to twice that of the crystal. For fundamental operation SW1 is closed, the fundamental coil inserted in the plate circuit and SW2 thrown so as to connect this coil to the other plate. The circuit now becomes a push-pull oscillator for fundamental operation. For push-push operation at twice the crystal frequency the fundamental coil is put in the screen-suppressor circuit and SW1 opened. The coil tuning to twice the crystal frequency is inserted in the plate circuit and SW2 thrown so as to connect the two plates together. We now have all *second harmonic* output. In an experimental set-up using a single 59 as a *straight* pentode crystal oscillator and a 400 volt power supply, the output was *8 watts on 80 meters*. Changing over to the well known "tritrit" circuit the output was 5 watts on 40 meters. Using the same crystal and power supply in the circuit of Fig. 9 gave an output of *16 watts on 80 meters and 15 watts on 40 meters*.

## STANCOR TRANSFORMERS

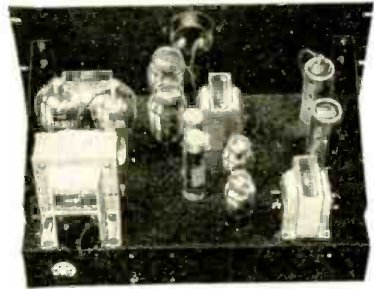

FOR THIS  
**100 WATT** \$12<sup>21</sup>  
MODULATOR

THIS inexpensive but efficient modulator delivers 100 clean watts of audio with 800 volts on the plates of the modulator tubes. Built on standard Relay Rack and Panel.

TUBES: 6C6 Pre-amplifier; 76 voltage amplifier; Push-Pull 76's; 6A3 Drivers; TZ-20 Class B Modulators.

STANCOR TRANSFORMERS: Push-Pull Input, XA4206; Push-Pull Interstage, XA4208; Push-Pull Driver, XA4212; Output, XA2908.

FREE BLUEPRINT AND LAYOUT TEMPLATE

STANDARD  
TRANSFORMER  
CORPORATION  
850 BLACKHAWK ST., CHICAGO

## AND NOW—

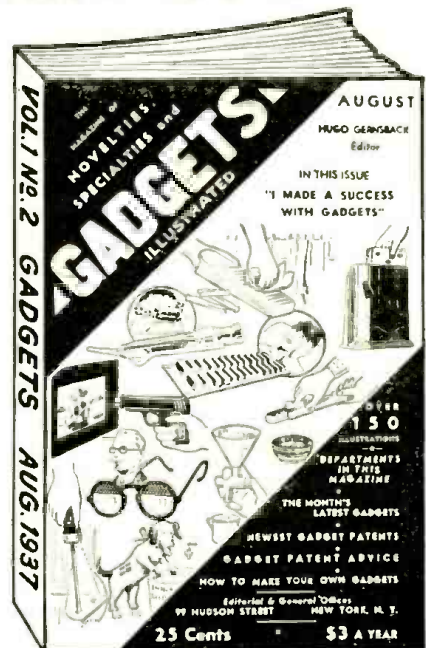

The world's only magazine on this subject. Contains 150 illustrations of the latest and best gadgets, novelties, and specialties. A veritable gold mine of information which you can not get in any other way.

Every month, GADGETS ransacks not only America but the entire world for the newest, most useful articles of this type. Including the latest gadget and novelty patents.

Don't fail to read the monthly articles how inventors of well known gadgets have made fortunes from their ideas.

If your newsdealer cannot supply GADGETS MAGAZINE send 25c to

**GADGETS Magazine**  
99-5 Hudson Street, New York City

Please mention SHORT WAVE & TELEVISION when writing advertisers



# All about the SHORT WAVE LEAGUE

## A FEW WORDS AS TO THE PURPOSE OF THE LEAGUE

The SHORT WAVE LEAGUE was founded in 1930. Honorary Directors are as follows: Dr. Lee de Forest, John L. Reinartz, D. E. Replogle, Hollis Baird, E. T. Somerset, Baron Manfred von Ardenne, Hugo Gernsback, Executive Secretary.

The SHORT WAVE LEAGUE is a scientific membership organization for the promotion of the short wave art. There are no dues, no fees, no initiations, in connection with the LEAGUE. No one makes any money from it; no one derives any salary. The only income which the LEAGUE has is from its short wave essentials. A pamphlet setting forth the LEAGUE'S numerous aspirations and purposes will be sent to anyone on receipt of a 3c stamp to cover postage.

## FREE MEMBERSHIP CERTIFICATE

As soon as you are enrolled as a member, a beautiful certificate with the LEAGUE'S seal will be sent to you, providing 10c in stamps or coin is sent for mailing charges.

Members are entitled to preferential discounts when buying radio merchandise from numerous firms who have agreed to allow lower prices to all SHORT WAVE LEAGUE members.

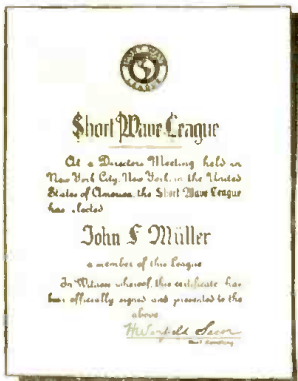

If you wish your name engraved on the Free membership certificate, as illustrated above, please send 25c to cover cost.

## SHORT WAVE ESSENTIALS LISTED HERE SOLD ONLY TO SHORT WAVE LEAGUE MEMBERS

They cannot be bought by anyone unless he has already enrolled as one of the members of the SHORT WAVE LEAGUE or signs the blank on this page (which automatically enrolls him as a member, always provided that he is a short wave experimenter, a short wave fan, radio engineer, radio student, etc.).

Inasmuch as the LEAGUE is international, it makes no difference whether you are a citizen of the United States or any other country. The LEAGUE is open to all.

## Application for Membership SHORT WAVE LEAGUE

SHORT WAVE LEAGUE 9-37 99-101 Hudson Street, New York, N. Y. I, the undersigned, herewith desire to apply for membership in the SHORT WAVE LEAGUE. In joining the LEAGUE I understand that I am not assessed for membership and that there are no dues and no fees of any kind. I pledge myself to abide by all the rules and regulations of the SHORT WAVE LEAGUE, which rules you are to send to me on receipt of this application. I consider myself belonging to the following class (put an X in correct space): Short Wave Experimenter  Short Wave Fan  Radio Engineer  Student  I own the following radio equipment:

Transmitter.....  
Call Letters.....  
Receiving.....  
Name.....  
Address.....  
City and State.....  
Country.....

I enclose 10c for postage and handling for my Membership Certificate.

## Water-Cooled Tube

(Continued from page 244)

higher frequencies, either type can be used with maximum input at frequencies as high as 300 megacycles. No. 643.

### RCA-887

As R-F Power Amplifier—Class C Telephony. Carrier conditions per tube for use with a max. modulation factor of 1.0.

D-C PLATE VOLTAGE	2000 max. Volts
D-C GRID VOLTAGE	-500 max. Volts
D-C PLATE CURRENT	200 max. Milliamperes
D-C GRID CURRENT	75 max. Milliamperes
PLATE INPUT	400 max. Watts
PLATE DISSIPATION	400 max. Watts

TYPICAL OPERATION:

D-C Plate Voltage	1500	2000 Volts
D-C Grid Voltage	-450	-600 Volts
Peak R-F Grid Voltage	800	850 Volts
D-C Plate Current	200	200 Milliamperes
D-C Grid Current		

(Approx.)	50	50 Milliamperes
Driving Power		
(Approx.)	35	40 Watts
Power Output		
(Approx.)	200	300 Watts

This article has been prepared from data supplied by courtesy of RCA Radiotron Division.

## New "Overseas" Dial Makes S-W Tuning Easy

(Continued from page 233)

ing the loudspeaker unit has been scientifically sealed in a chamber shaped like an arc. The back waves from the speaker are thus controlled, directed and released through a number of measured openings to blend with the sound coming out of the front of the set and create a truly natural tone quality. This new Sonic-Arc Magic Voice eliminates the boominess and over-emphasis of the low tones found in many other receivers.

Added to all of these new developments are innumerable other features, such as the Magic Brain and Magic Eye, which with almost human intelligence direct and control the functions of the radio set.

(This article has been prepared from data supplied by courtesy of RCA Manufacturing Co.)

## Mechanical Scanning for Television

(Continued from page 213)

scanning as much as 1,000 line pictures, either at the transmitter or the receiver. It will, doubtless, be some time until such television is ready for the market.

The first television which the public is likely to see will, I am confident, be a television news service developed in our laboratories. In this, letters 6 inches high will be seen moving across a screen 3 feet wide, spelling out the latest news of the day as to world affairs, politics, sports, stock exchange prices, weather, etc. Interspersed among such bulletins there may be advertising notices of business houses. While news has been transmitted by mechanical typewriters over wire lines, hitherto, such apparatus was neither noiseless nor inexpensive and particularly in these days, expense is a matter which concerns most everyone. By using television news equipment, these disadvantages are eliminated for only a simple receiver and scanning disc, modulator tube and light source are needed.

Transmission is equally simple, being accomplished by typing messages on transparent tape, which is then scanned mechanically. The electrical impulses thus broadcast being transmitted either over land lines or by radio. Such apparatus has been operating successful at our laboratories for more than a year and we feel it will bring the public its first glimpse of practical commercial television.

## Accessories for Members of the SHORT WAVE LEAGUE

Every member of the SHORT WAVE LEAGUE wants to identify himself in some way. For your convenience the League directors have prepared suitable letterheads, label buttons, stickers, etc. In addition there are many short-wave accessories, such as maps, globes, etc., which the League offers only to members at special prices. Take your choice from this advertisement. THESE ESSENTIALS ARE SOLD ONLY TO LEAGUE MEMBERS.

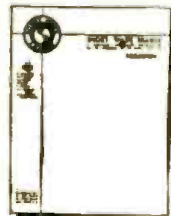

### LEAGUE LETTERHEADS

A beautiful, official letterhead has been designed for members' correspondence. The letterhead is invaluable when it becomes necessary to deal with the radio industry, mail order houses and radio manufacturers, as many of these offer members of the LEAGUE preferential discount. The letterhead is also absolutely essential when writing for verification to radio stations either here or abroad. It automatically gives you a professional standing.

A—SHORT WAVE LEAGUE letterheads. 50c per 100

A—50c per 100

### WORLD GLOBE

This important essential is an ornament for every den or study. It is a globe, 6 in. in diameter, printed in fifteen colors, glazed in such a way that it can be washed. This globe helps you to intelligently log foreign stations. The base is of solid walnut, and the semi-meridian of a nickel-like metal. Entire device substantially made and will give an attractive appearance to every station, emphasizing the long-distance work of the operator.



D—Globe of the World 89c

D—89c each

### SHORT WAVE MAP OF THE WORLD

This beautiful map, measuring 18x26 in. and printed in 18 colors is indispensable when hung in sight or placed "under the glass" on the table or wall of the short wave enthusiast. It contains a wealth of information such as distances to all parts of the world, political nature of the country in which a broadcast station is located, etc., and from the manner in which the map is blocked off gives the time in different parts of the world at a glance.



F—SHORT WAVE Map of the World. 25c

### WORLD RADIO MAP AND STATION FINDER

The finest device of its kind published. The world's map on heavy board is divided into 23 sections, while the rotary disc shows you immediately the exact time in any foreign country. Invaluable in logging foreign stations. Also gives call letters assigned to all nations. Size 11"x22".

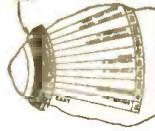

C—Radio Map of the World and Station Finder. 25c

C—25c each

### LEAGUE LABEL BUTTON



E—35c each

### LEAGUE SEALS



G—15c for 25

These seals or stickers are executed in three colors and measure 1 1/4 in. in diameter, and are gummed on one side. They are used by members to affix to stationery, letterheads, envelopes, postal cards and the like. The seal signifies that you are a member of the SHORT WAVE LEAGUE. Sold in 25 lots or multiples only.

H—SHORT WAVE LEAGUE seals, per 25. 15c

### SHORT WAVE LEAGUE

99-101 Hudson St., New York, N.Y.

SHORT WAVE LEAGUE, 99-101 Hudson Street, New York, N. Y. 9-37

I am a member in the SHORT WAVE LEAGUE. Please send me application for membership in the SHORT WAVE LEAGUE. Please send me the following short wave essentials as listed in this advertisement:

for which I enclose \$..... herewith.  
Name.....  
Address.....  
City and State.....  
Country.....  
(The LEAGUE accepts money order, cash or new U. S. Stamps in any denomination. Register cash and stamps.)



## Short Wave Scouts

(Continued from page 229)

- OLR3A—9.550 mc.—Czechoslovak Shortwave Station. Praha, Praha XII., Fochava 16, Czechoslovakia.
  - ORK—10.330 mc.—Radio Ruysselede, West Flanders, Belgium.
  - Radio-Coloniale—15.245 mc.—"Radio-Coloniale", Paris, France.
  - Radio-Coloniale—11.880 mc.—"Radio-Coloniale", Paris, France.
  - Radio-Coloniale—11.715 mc.—"Radio-Coloniale", Paris, France.
  - DJA—9.560 mc.—Deutschen Kurzwellsenders, Berlin, Germany.
  - DJB—15.200 mc.—(Same as above)
  - DJD—11.770 mc.—(Same as above)
  - DJE—17.760 mc.—(Same as above)
  - DJJ—15.110 mc.—(Same as above)
  - DJN—9.540 mc.—(Same as above)
  - DJO—11.795 mc.—(Same as above)
  - DJP—11.855 mc.—(Same as above)
  - DJQ—15.280 mc.—(Same as above)
  - DJK—15.340 mc.—(Same as above)
  - DZB—10.042 mc.—(Same as above)
  - DZC—10.290 mc.—(Same as above)
  - DZH—14.460 mc.—(Same as above)
  - PHI—17.775 mc.—Philips Radio, Huizen, Holland.
  - HAT4—9.125 mc.—"Radiolabor" Gyal-ut 22, Budapest, Hungary.
  - HAS3—15.370 mc.—"Radiolabor", Gyal-ut 22, Budapest, Hungary.
  - 2RO-3—9.635 mc.—E.I.A.R., Rome, Italy.
  - 2RO-4—11.810 mc.—E.I.A.R., Rome, Italy.
  - HVJ—15.120 mc.—Vatican City.
  - Shortwave Radio Station—6.100 mc.—Belgrade-Poste Emetteur A Ondes Courtes, Belgrade, Jugoslavia.
  - CT1AA—9.650 mc.—Radio Colonial, Av. Antonio Augusto d'Aguiar, 144, Lisbon, Portugal.
  - RAN—9.600 mc.—Radio Centre Moscow, U.S.S.R.
  - RNE—12.000 mc.—Radio centre Moscow, U.S.S.R.
  - EAQ—9.860 mc.—P.O. Box 951, Madrid.
  - HBJ—14.535 mc.—Radio Nations, Geneva, Switzerland.
  - HBL—9.595 mc.—Radio Nations, Geneva, Switzerland.
  - HBP—7.799 mc.—Radio Nations, Geneva, Switzerland.
- Asia**
- JVN—10.660 mc.—Kokusai-Denwa Kaisha Ltd., Osaka Bldg., Kojimachiku, Tokyo, Japan.
  - JZJ—11.800 mc.—Kokusai-Denwa Kaisha Ltd., Osaka Bldg., Kojimachiku, Tokyo, Japan.
  - XGOX—6.850 mc.—The Central Broadcasting Administration, Nanking, China.
- Australia**
- VK2ME—9.590 mc.—"The Voice of Australia", Amalgamated Wireless, Ltd., 47 York St., Sydney, Australia.
  - VK3ME—9.510 mc.—Amalgamated Wireless Ltd., Melbourne, Australia.
  - VK3LR—9.580 mc.—National Short-wave Transmitter, Lyndhurst, Victoria, Australia.
- Sweden**
- SM5SX—11.705 Mc.—Royal Technical University, Stockholm, Sweden.
- Iceland**
- TFJ—12.235 Mc.—Icelandic State Broadcasting Service, Reykjavik, Iceland.
- Canary Islands**
- EAJ43—10.370 Mc.—Apartado de Correos, 225, Santa Cruz de Tenerife, Canary Islands.
- Africa**
- EA9AH—14.200 Mc.—Tetuan, Spanish Morocco.



## BRINGS YOU ANY ONE OF THESE 4 FAMOUS RADIO BOOKS

RADIO FANS! Help yourselves to a radio education for the price of 10c per book. These books give you a good foundation towards the study of radio. You'll be amazed at the wealth of information contained in them. They are especially written for beginners but are useful review and reference books for all.

Each book contains 32 pages, profusely illustrated with clear, self-explanatory diagrams. They contain over 15,000 words of clear legible type. They are an education in themselves and lay the groundwork for a complete study of radio and electricity.

### HOW TO BUILD FOUR DOERLE SHORT-WAVE SETS

Due to a special arrangement with the publishers of SHORT WAVE CRAFT, we present in this book complete details for building the Doerle sets, also an excellent power pack if you plan to electrify any of the sets. This book contains EVERYTHING that has ever been printed on these famous receivers. These are the famous sets that appear in SHORT WAVE CRAFT: "A 2-Tube Receiver that Reaches the 12,500 Mile Mark," by Walter C. Doerle, "A 2-Tube 'Signal Gripper,'" by Walter C. Doerle, "The Doerle

### HOW TO MAKE THE MOST POPULAR ALL-WAVE 1- AND 2-TUBE RECEIVERS

This book contains a number of excellent 1- and 2-tube sets, some of which have appeared in past issues of RADIO CRAFT. These sets are not toys, but have been carefully engineered. They are not experiments. To mention only a few of the sets the following will give you an idea. The Megadyne 1-Tube Pentode Loudspeaker Set, by Hugo Gernsback—Electrifying The Megadyne—How to Make a 1-Tube Loudspeaker set, by W. P. Chesney—How to Make a Simple 1-Tube All-Wave Electric Set, by F. W. Harris—How To Build A Four-in-Two All-Wave Electric Set, by J. T. Bernsley, and others.

Each set is fully described in simple language so that anyone can build with practically no experience a worthwhile all-wave radio set.

Has 30 illustrations. 10c postpaid

### ALTERNATING CURRENT FOR BEGINNERS

This book gives the beginner a foothold in electricity and radio. Electric circuits are explained. This includes Ohm's Law, alternating current, sine waves, volts, amperes, watts, condensers, transformers, motors and generators, A.C. instruments, house-wiring systems, electrical appliances and electric lamps. Here are some of the practical experiments which you can perform. Simple tests for differentiating between A.C. and D.C., how to light a lamp by induction; making a simple electric horn; demagnetizing a watch; testing motor armatures; charging storage batteries from A.C. outlet; testing condensers with A.C.; making A.C. electromagnets; frying eggs on a cake of ice; making simple A.C. motors and many others. Has 42 illustrations.

10c postpaid

### ALL ABOUT AERIALS

In simple, understandable language this book explains the theory underlying the various types of aerials; the inverted "T," the Doublet, etc. It explains how noise-free reception can be obtained, how low-impedance transmission lines work; why transposed lead-ins are used. It gives in detail the construction of aerials suitable for long-wave broadcast receivers. For

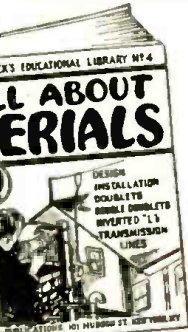
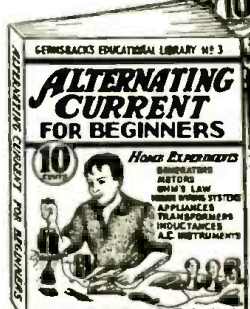
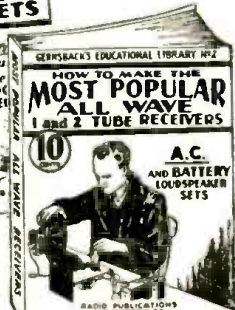
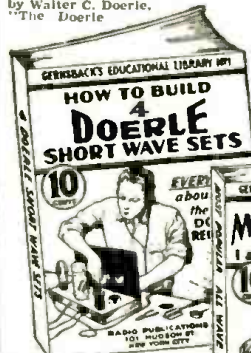

2-Tube\* Adapted to A. C. Operation. "The Doerle 3-Tube 'Signal Gripper' Electrified," and "The Doerle G o s e 'Band Spread,'" Has 30 illustrations. 10c postpaid

Remember that each book has 32 pages and contains over 15,000 words. Each book has from 30 to 66 fine illustrations. POSITIVELY THE GREATEST 10c VALUE IN RADIO BOOKS EVER OFFERED TO THE PUBLIC.

If you do not think that these books are worth the money asked for them, return them within 24 hours and your money will be instantly refunded.

Send for our FREE circular listing 48 new 10c Publications

**RADIO PUBLICATIONS**  
101 Hudson St., New York, N. Y.

**RADIO PUBLICATIONS** SWT-937  
101 Hudson Street, New York, N. Y.

Please send immediately POSTPAID the books checked:

- No. 1—How to Build 4 Doerle Short Wave Sets.....10c
- No. 2—How to Make the Most Popular All-Wave 1- and 2-Tube Receivers.....10c
- No. 3—Alternating Current for Beginners.....10c
- No. 4—All About Aerials.....10c

I am enclosing.....c; the price of each book is 10c

Send me FREE circular listing 48 new 10c publications

Name \_\_\_\_\_

Address \_\_\_\_\_

City \_\_\_\_\_ State \_\_\_\_\_

(U. S. Coin or U. S. Stamps acceptable.) Books are sent postpaid.

## Trophy Contest Rules

- THE first of the new contests will be for the greatest number of verified stations heard in Asia. You may "listen in" from now until Aug. 25th.
- A notarized affidavit must be sent with the ver cards and, of course, all of the veris will have to be for the contest assigned for each particular contest. The Asia "listening in" contest will close Aug. 25th, and the trophy award will be announced in the November number.
- A—By midnight August 25th all entries for the Asia contest must therefore be in the hands of the Editors, together with the veris and the notarized oath that the contestant personally listened to all of the stations listed.
- B—For the next issue, the October number, trophies will be awarded on the basis of the old rules, which require that 50% of the stations heard and verified must be foreign, and also that the listening time may be any 30-day period. In either contest, and in the event of a tie between two or more contestants, each listing the same number of stations, the judges will award a similar trophy to each contestant so tying.

# CLASSIFIED

Advertisements are inserted at 5c per word to strictly amateurs, or 10c a word to manufacturers or dealers. Each word in a name and address is counted. Cash should accompany all orders. Copy for the October issue should reach us not later than August 5.

**AGENTS WANTED**

**GOLD LETTERS FOR STORE**  
Windows. 500% Profit. Free Samples. Metallic Co., 433-R N. Clark, Chicago.

**"HAM" OFFERS AND WANTS**

**R-3 LISTENERS LEAGUE** WOULD you like to join a friendly radio league, where you can swap QSL cards, photos, stamps or can have pen pals? Write to 7417-87th Ave., Woodhaven, N.Y.

**WANTED USED TRANSMITTER**  
Give Details. K. Hume, Boothbay Harbor, Maine.

**SELL: SKY-BUDDY, AI COND.**  
\$25.00. Adeline Belford, Clay Center, Nebraska.

**INSTRUCTION**

**COMPLETE TRAINING FOR ALL**  
Amateur and Professional Radio Licenses. New York Wireless School, 1123 Broadway, New York.

**MISCELLANEOUS**

**WE ORIGINALLY HAD FIVE**  
thousand Stoppant Compasses for which the U.S. Government paid over \$30.00 each. We sold all but a very few. We cannot obtain more to sell at three times our present price. Send in your order before they are all sold at \$4.50 each, postage paid. Gold Shield Products, Room 14, Eleventh floor, 99 Hudson St., New York City.

**COIL INDUCTANCE CHARTS**—complete set for any size coil; accuracy, \$2.15 pre-paid. Slide Rules—4 inch circular type \$2.00; 8" dia., 20" scale, \$5.00 pre-paid. Dataprint Co., Box 322, Ramsey, N.J.

**PATENT ATTORNEYS**

**INVENTORS, ALL PATENT AND**  
trademark cases submitted given per-

sonal attention by members of the firm. Form "Evidence of Conception" and instructions free. Lancaster, Allwine & Roumel, 426 Bowen Building, Washington, D. C.

**QSL-CARDS-SWL**

**100 NEAT SWL CARDS PRINTED**  
with your name and address sent post-paid for \$1. (Bunch of samples and RST chart for five cent stamp. WIREP, 16 Stockbridge, Lowell, Mass.

**QSL SWL CARDS, NEAT, ATTRACTIVE,** reasonably priced, samples free. Miller, Printer, Ambler, Pa.

**SHORT WAVE RECEIVERS**

**BEGINNERS, MAKE CRYSTAL**  
Pocket and Short Wave Sets. South-Western Laboratories, Santa Ana, Calif.

**5 METER SETS, KITS \$1.59.** MURSON Radio, 151 Quincy Street, Brooklyn.

Please mention SHORT WAVE & TELEVISION when writing advertisers





- ★ Latest version of popular type molded mica capacitor. Screw terminals. Tapered sides.
- ★ Capacity and test voltage values stamped on each unit. Color coded on reverse side.
- ★ A superior high-voltage high-frequency capacitor. 1000 to 10,000 D.C. test voltage ratings. .00005 to .05 mfd.

**New CATALOG . . . .**

Bix. Startling. 32-page book. Just issued. Ask local supplier or write us for copy, TODAY.

**AEROVOX**  
CORPORATION  
70 Washington St. : : Brooklyn, N. Y.

**KENYON**

EFFICIENT

RELIABLE

MODERN

LOW PRICED

**KEN-O-TAP**  
*The RELIABLE Solution To The Modulation Problem*

**KEN-O-DRIVE**  
*The MODERN Answer To Critical Driver Operation*

**KEN-O-DYNE**  
*The Precision Method of Matching Output Tubes to Speakers*

**KEN-O-LINE**  
*The EFFICIENT Coupling Device From UNIVERSAL LINE*

Ask Your Dealer For Our 16 Page "T" Line Catalog Which Contains One Of The Most Complete Lines of Audio And Power Components Ever Presented. Also Contains A Large Selection Of Modern Audio Circuits.

**Kenyon Transformer Co., Inc.**  
840 Barry St. New York, N. Y.  
Export Dept. New York, N. Y. 25 Warren St.

C—Bear in mind that the veri cards should be absolute verifications, and not simply an acknowledgement that you notified a station that you heard them. Several stations do not verify, but simply send an acknowledgement card. Note that in either contest that only experimental phone or broadcast stations should be entered in your list. No amateur transmitters or commercial code stations can be entered. For the October contest, which follows our regular rules, the entries must be in the Editor's hands by midnight of the 25th day of the month for the next succeeding issue. The contest for the October issue will close in New York City, July 24th, etc.

The judges in each contest will be the Editors of *Short Wave & Television* and the opinion of the judges will be final. Send veri cards with your letter and oath certificate all in one package. Use a single line for each station and list them in a regular order, such as: frequency, schedule. (All time should be reduced to E.S.T., which is five hours behind Greenwich Meridian Time.) Name of station, city, country; musical identification signal if any.

**Notice To Trophy Contestants**

● The closing date for the Asia contest announced in the May issue, has been advanced from June 25th to August 25th, in order to provide sufficient time for the veris to reach the contestants from Asiatic stations. Note: We are also including in the Asia group, short-wave stations in the Philippines and the East Indies. The group for which entries must be in the Editor's hands by September 25th are Australia, Africa and Oceania. The group in which entries must be in our hands by October 25th, includes the veris from European short-wave stations, including Iceland. For entries to be in the Editor's hands by November 25th, North America (including Central America, West Indies, Canada and Mexico) veris are to be in by that time. For entries to be in our hands by December 24th, South American stations are the objective.

**Special Purpose Mike**



A new model of the well-known Velotron microphone has recently been introduced. It is a rather small unit, 3/4" thick, by 2 1/2" high, by 2 3/4" wide. It is designed with a flat mounting surface, permitting it to be fastened directly to the pre-amplifier unit, or it can be operated as a lapel microphone.

The output is -55 DB and it is designed to work directly into the grid of the first amplifier. The frequency response is adjustable from 30 to 14,000 cycles per second. This response is adjusted by varying the polarizing voltage from between 150 volts to 350 volts. It is furnished in two finishes, one model in gun metal and the other in chromium.

*This article has been prepared from data supplied by courtesy of Bruno Lab. Inc.*

**CQ**

A local "B. C. L." failed to catch the joke when he asked W4VK to see what was wrong with the set. 4VK found the B. C. L. had thrown away all tube shields as the instructions had said remove all tube cartons before using!—Barnett Mitchell.

B. C. L. to S. W. L.—"What do you have to do to become a "Ham," get smoked?—J. C. Balloch.

● Index to Advertisers ●

<b>A</b>	
Ace Radio Laboratories.....	250
Aerovox Corporation.....	272
Allied Engineering Institute.....	262
Allied Radio Corp.....	211
Astatic Microphone Laboratory, Inc.....	255
<b>B</b>	
Bliley Electric Co.....	265
Brach, L. S., Mfg. Corp.....	252
Bruno Laboratories.....	267
Brush Development Co. The.....	258
<b>C</b>	
Cameradio Co.....	265
Candler System Co.....	261
Cardwell, Allen D. Mfg. Corp., The.....	258
Classified Advertisements.....	271
Cornell-Dubilier Corp.....	248
Cornish Wire Co.....	264
Coyne Electrical School.....	263
Crosley Radio Corporation, The.....	259
<b>D</b>	
Dataprint Company.....	264
Dodge's Institute.....	260
<b>E</b>	
Eilen Radio Laboratories.....	249
Electric Institute, Inc.....	256
Electric Maintenance Service Co., Inc.....	254
<b>G</b>	
Gadgets Magazine.....	269
Gold Shield Products Co.....	265
Goldentone Radio Co.....	266
<b>H</b>	
Hallcrafters, Inc.....	Back Cover
Hammarlund Manufacturing Co., Inc.....	267
Harrison Radio Company.....	248
<b>I</b>	
Instructograph Company.....	260
<b>K</b>	
Kenyon Transformer Co., Inc.....	272
Korrol Radio Products Co.....	252
<b>M</b>	
McElroy, T. R.....	261
Midland Television, Inc.....	261
Midwest Radio Corporation.....	247
Milady.....	268
<b>N</b>	
National Company, Inc.....	Inside Back Cover
National Radio Institute.....	209
National Schools.....	261
New York Y.M.C.A. Schools.....	260
<b>P</b>	
Par-Metal Products Corporation.....	267
Polk, R. L., & Co.....	262
<b>R</b>	
Radcraft Publications.....	265
Radio Amateur Course.....	212
Radio & Television Institute.....	261
Radio Constructors Laboratories.....	253
Radio Craft.....	268
Radio Publications.....	268, 271
Radio Training Assn. of America.....	260
Raytheon Production Corporation.....	257
RCA Institutes, Inc.....	261
RCA Manufacturing Company, Inc.....	Inside Front Cover
<b>S</b>	
Sargent, E. M., Co.....	255
Short Wave Coil Book.....	264
Short Wave League.....	270
Solar Mfg. Corp.....	254
Sprague Products Co.....	265
Standard Transformer Corporation.....	269
Superior Instruments Company.....	252
<b>T</b>	
Teleplex Co.....	261
Triplet Electrical Instrument Co.....	258
Tri-State College.....	261
Try-Mo Radio Co., Inc.....	250
<b>U</b>	
Ultra High Frequency Products Co.....	251
United Radio Company.....	266
Utah Radio Products Co.....	254
<b>W</b>	
Wellworth Trading Company.....	262, 266
Wholesale Radio Service Co., Inc.....	255

(While every precaution is taken to insure accuracy, we cannot guarantee against the possibility of an occasional change or omission in the preparation of this index.)

Please mention SHORT WAVE & TELEVISION when writing advertisers





# NATIONAL DIALS

The fine finish of a National Dial adds distinction to the appearance of your equipment, and its accuracy insures precision. For years National Dials have been preferred on the best of quality apparatus. The four-inch Type N Dial, with its solid nickel-silver scale and flush vernier, is a favorite wherever smooth accuracy is needed. The plain Type O Dial permits thrift without sacrifice of appearance

when vernier tuning is not required. For years a favorite, the Type B combines adjustable ratio with a concealed built-in illuminator. The small HRO Dial is an ideal position indicator for controls such as volume or regeneration. There is a National Dial for every purpose. They are listed in the National Catalogue. The coupon below will bring a copy.

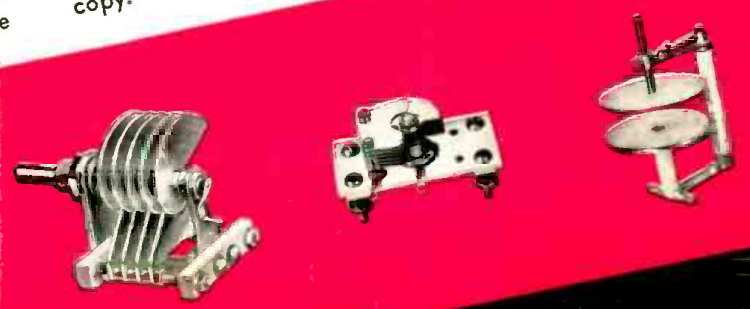

# NATIONAL CONDENSERS

National Condensers are the result of years of specialized design. Every detail from material to mounting has been studied to achieve high performance. The PW Condenser with preloaded worm drive and micrometer dial has no competitor for precision and electrical efficiency. The TMC is a husky little transmitting condenser that is typical of a whole series of rigid, low-loss units. The SE Midget

Receiving Condenser is outstanding for such refinements as non-inductive pigtail and insulating main bearing. Type UM is an extremely versatile little unit that fits easily in awkward places. NC 500 is the largest of a series of low-loss, high-voltage neutralizing condensers. There is a National Condenser for every purpose. Most are listed in the National Catalogue. The coupon below will bring a copy.



# NATIONAL COIL FORMS

The design of National Coil Forms is based on actual experience in constructing receivers and other equipment. They are *right*. The XR-10A, XR-12A and XR-13 transmitter coil forms are of low-loss ceramic and are far superior to ordinary porcelain forms. A data sheet, supplied with each form, makes it easy to determine the proper

number of turns to use for any amateur band. The low-loss R-39 coil forms are of excellent form factor and convenient size for receiver circuits. They can be readily drilled or threaded. National Coils are convenient, too. Handy and versatile plug-in mounts are supplied for popular sizes. They are described in the National Catalogue. The coupon below will bring a copy.



NATIONAL COMPANY, INC., 61 SHERMAN STREET, MALDEN, MASS.

Gentlemen: Please send me a free copy of your general catalogue.

Name: \_\_\_\_\_ Address: \_\_\_\_\_



# MAXIMUM USABLE

# BAND SPREAD



PITCH CON

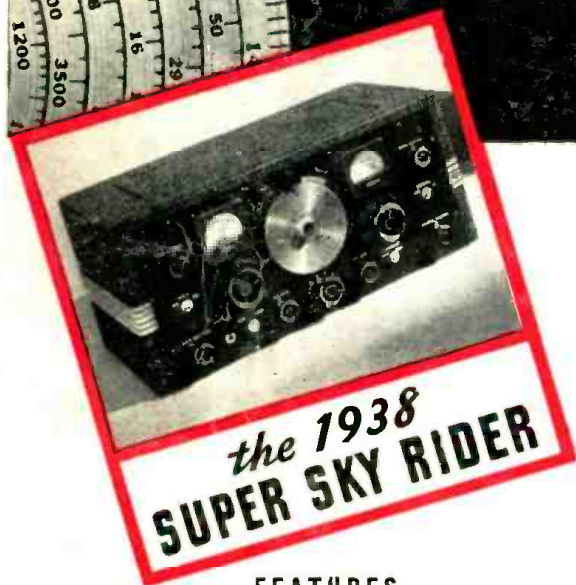

*the 1938*  
**SUPER SKY RIDER**

#### FEATURES

- ★ 5 to 550 Meters Coverage
- ★ 6 Bands
- ★ 11 Tubes
- ★ Wide Range Variable Selectivity
- ★ Better Than One Microvolt Average Sensitivity on All Bands
- ★ Improved Crystal Filter Control
- ★ 1000° Electrical Band Spread
- ★ "S" Meter
- ★ 13 Watt Undistorted Output
- ★ Air-Trimmed R. F. Circuit
- ★ Improved Expanding I. F. Transformers

Send for illustrated booklet completely describing the New 1938 Super Sky Rider.

## PLUS A NEW HIGH ORDER OF SELECTIVITY\* FOR GREATER STATION SEPARATION . . .

The New 1938 Super Sky Rider exceeds by as much as 500% the most exacting standards for Band Spread on communications receivers. Here's an entirely new approach to Band Spread design, electrically and mechanically, with an ingenious new spiral dial.

Imagine the sheer pleasure of working the crowded bands of today with this revolutionary new band spread, which with the outstanding new selectivity of the Super Sky Rider permits a degree of station separation on short waves that has never been available before.

This is but one of the new and exclusive features of the New 1938 Super Sky Rider that makes it the perfect receiver for amateur and professional operators and short wave listeners as well.

*\*Two Stages of Specially Designed Iron Core I. F.*

Ask your dealer about the Hallicrafters' Time Payment Plan.

## the hallicrafters inc.

2601 INDIANA AVE., CHICAGO, U.S.A.  
Cable Address, "Hallicraft" Chicago

"America's Leading Manufacturers of Communications Receivers"